

Practical Microbiology

**based on the Hungarian practical notes entitled
"Mikrobiológiai Laboratóriumi Gyakorlatok"**

Practical Microbiology: based on the Hungarian practical notes entitled "Mikrobiológiai Laboratóriumi Gyakorlatok"

Authors of the Hungarian and English versions: Erika M. Tóth, Andrea K. Borsodi, Tamás Felföldi, Balázs Vajna, Rita Sipos and Károly Márialigeti

Authors of the Hungarian version: Csaba Romsics, Judit Makk, Katalin Jáger, Márton Palatinszky and Éva Ács

Editors of the English version: Erika M. Tóth and Károly Márialigeti

Language assistant: Attila Náfrádi

Copyright © 2013 Eötvös Loránd University

This book is freely available for research and educational purposes. Reproduction in any form is prohibited without written permission of the owner.

Made in the project entitled "E-learning scientific content development in ELTE TTK" with number TÁMOP-4.1.2.A/1-11/1-2011-0073. Consortium leader: Eötvös Loránd University, Consortium Members: ELTE Faculties of Science Student Foundation, ITStudy Hungary Ltd.

National Development Agency
www.ujszechenyiterv.gov.hu
06 40 638 638



The project is supported by the European Union
and co-financed by the European Social Fund.

Table of Contents

1. PREFACE	v
2. WORK IN A MICROBIOLOGICAL LABORATORY	1
2.1. Biological safety level categories and the airborne route of pathogen transmission	1
2.2. The principle of containment, the setup and basic pieces of equipment of a microbiological laboratory	2
2.3. Biological safety cabinets	4
2.4. Behaviour and work in a microbiological laboratory	5
2.4.1. What to do in case of biological spill (involving BSL2 microorganisms)	7
2.4.2. Decontaminating hygienic hand wash and personal decontamination	7
2.4.3. Emergency and first aid guide	8
3. STERILISATION AND DISINFECTION	10
3.1. Procedures of sterilisation	10
3.1.1. Sterilisation by heat	10
3.1.2. Sterilisation by radiation	12
3.1.3. Filter sterilisation	12
3.1.4. Sterilisation by chemicals	13
3.2. Procedures of disinfection	13
3.3. Control of the efficacy of sterilisation equipment	14
3.4. Determination of the microbiological efficacy of disinfectants	15
4. SAMPLING METHODS IN MICROBIOLOGY	17
4.1. Sampling for diagnostic purposes	17
4.2. Sampling from various environments	17
4.2.1. Collection of air samples	17
4.2.2. Collection of soil samples	19
4.2.3. Collection of water samples	20
4.2.4. Sampling the surface of objects	21
4.2.5. Hygienic control of the hands of operators	22
5. INTRODUCTION TO THE USE OF PRACTICAL LABORATORY MICROSCOPES	24
5.1. Bright-field light microscopy	24
5.2. Fluorescence microscopy	26
6. CELL- AND GERM-COUNTING METHODS	27
6.1. Determination of cell counts with microscope	27
6.2. PCR-based cell counts	30
6.3. Determination of germ counts based on cultivation	30
6.3.1. CFU-counting techniques	30
6.3.2. The membrane filter technique	33
6.3.3. The end point dilution technique (MPN method)	34
7. STRAIN CULTURE AND CULTIVATION-BASED TECHNIQUES	36
7.1. Demonstration of microbes in the environment	36
7.2. Preparation of microbiological culture media	38
7.3. Basic bacterial cultivation techniques	42
7.3.1. Enrichment	42
7.3.2. Spread plate and pour plate methods	44
7.3.3. Isolation and streak plate technique	44
7.3.4. Anaerobic cultivation techniques	47
7.3.5. Transfer, maintenance and storage of pure cultures	50
7.4. Pheno- and genotypic characterisation of bacterial strains	54
7.4.1. Colony- and cell morphology, staining procedures	54
7.4.2. Study of bacterial enzymes	66
7.4.3. Physiological and ecological studies on bacterial strains	75
7.4.4. Study of the effect of antimicrobial compounds and antibiotics	79
7.4.5. Chemotaxonomical studies of bacterial strains	87
7.4.6. Bacterial species identification based on 16S rDNA sequence homology	92
8. ANALYSIS OF THE MICROBIOLOGICAL QUALITY OF DIFFERENT ENVIRONMENTS	104
8.1. Microbiology of surface waters and wastewaters, hygienic control	104

8.2. Soil examinations	108
8.3. Examination of microorganisms participating in the nitrogen cycle	110
8.4. Examination of microorganisms participating in the sulphur cycle	115
9. FERMENTATION PROCESSES IN BIOTECHNOLOGY	117
10. DATA ANALYSIS – TAXOMETRICS	121
11. BASIC ALGOLOGICAL METHODS	123
12. SUPPLEMENTARY MATERIAL	125
12.1 Supplementary exercises	125
12.2. Taxon information sheets with supplementary figures	133
12.3. Test results with supplementary figures	145
13. LIST OF EXERCISES	151
14. APPENDIX	155
14.1. Using LABOVAL 4 type microscopes for bright-field light microscopic observations	155
14.2. Culture media used in the practical	155
14.3. Dyes, reagents and solutions used in the practical	168
14.4. Tables	172
15. WORKING DEFINITIONS	175
16. REVIEW QUESTIONS	182
17. REFERENCES	222

1. PREFACE

The scientific community has always played distinguished attention to explorers of the remote quarters of our Earth, and to the description of their natural history. The founding fathers of microbiology, Louis Pasteur (1822-1895), Ferdinand Kohn (1828-1898) and Robert Koch (1843-1910), just to mention a few, were not yet born, or just started school, when Alexander von Humboldt (1769-1869) set sail to America and returned with an amazing collection of plants and fossils (1799-1804). The same is true in the case of Charles Darwin (1809-1882), who participated in an expedition circumnavigating our Globe on board the Beagle survey barque (1831-1836), described his observations, and returned with several plants and animals, etc.

This kind of work based on animated exploratory, descriptive data gathering in the field of microbiology started in the 1870's by the development of culture methods. By then, Darwin had already concentrated on his explanatory work on biogenesis and constituted his hypotheses on the origin of species. This work initiated an enormous series of hypothesis-driven studies. However, in scientific research, this kind of ambiguity (data-driven exploratory and descriptive studies versus hypothesis-driven explanatory and interpretative research) has always been characteristic. With the development of the novel genome-based molecular approaches, a new era of diversity exploration has started in microbiology. "Good old hypotheses" based on strain culture studies got turned around, but new data are not yet adequate to reach satisfactory explanations. It is intriguing to participate in this variegation of microbiological studies by either exploring the diversity, or explaining the scientific background of environmental observations.

This practical guide collects and explains the most basic techniques used in general microbiology. Mastering these methods will help the students in many other practical disciplines that apply the techniques of aseptic work, sterilisation and disinfection, or work with laboratory cultures. The series of practical exercises is compiled mainly according to the logic of the exploration and description of the microbial diversity of an environment. Thus, it starts with the description of a microbiological laboratory, preparatory work (sterilisation, etc.), environmental sampling, the microscopic investigation of samples, the methodology of culture and phenotypic characterisation of strains, and the basic molecular identification techniques. Finally, applied microbiological techniques are described briefly, like practises to characterise microbes participating in the various cycles of elements, or the basic techniques of microbiological qualification of water, and some essential biotechnologies.

The description of the practical exercises is built up similarly. They start with a short introduction describing the principle, then the object of the investigation (i.e. strains or environmental sample), and the applied tools and instruments are listed. The followed procedure is described in the end. The practical sessions in basic microbiology at Eötvös Loránd University, Faculty of Science are organized on a weekly basis throughout the semester. Thus, where possible, culture incubations last for a week (even when it is not the optimal duration) and students get many preparations pre-arranged (e.g. 24-hour cultures). On the contrary, advanced practical exercises (like in molecular microbial ecology) are organized into week-long blocks, thus these practical exercises are arranged accordingly.

There is every reason to expect a rapid change in basic microbiological laboratory methodology in the near future. The electronic edition makes frequent modifications possible. The authors will use this opportunity to delete, change, expand or insert exercises in due time.

Chapter 2. WORK IN A MICROBIOLOGICAL LABORATORY

Safety in a microbiological laboratory substantially differs from that in other (chemical or physical, etc.) laboratories because, in addition to hazardous chemicals, substances and operations that pose a laboratory work-related risk, there is a risk of infection when working with microbes. The presence of, and working with infectious agents and materials in a microbiological laboratory, i.e. the potential of acquiring laboratory-associated infection, assumes the application of hierarchical control methods. These control measures first take into account the knowingly or unknowingly (e.g. as is the case in environmental microbiology) handled infectious agents; the approval of laboratory practices and safety equipment used (good laboratory practices [GLP]; containment approach), and the level by which laboratory workers are aware of the risk of infection (behavioural factors). Therefore, safety programs and safety management are organised with these questions in mind.

Epidemiologic analysis of (laboratory acquired) infections (including not only symptomatic infections, but similarly nonsymptomatic seroconversions as well) made the constitution of risk categories among microbes possible (based on health effects, means of spreading, routes of entry, etc.); and biological safety level requirements in laboratories (containment measures combining laboratory practices, safety equipment and design) in order to prevent the exposure of the operator, their colleagues and the broader environment.

The most common ways of exposure to infectious agents are percutaneous inoculation (through injuries caused by sharp contaminated objects and animal bites, scratches, etc.), aerosol inhalation (as a result of spills, or caused by sprays associated with work procedures, e.g. vortexing; the mere opening of a Petri dish culture of a sporulating fungus; work with lyophilised cultures, etc.), and ingestion (e.g. during mouth pipetting, or by eating or drinking in the laboratory). Since the infectious dose of a disease-causing agent is vital, the higher concentration of microorganisms associated with certain research procedures (e.g. cultivation) increases the risk. “Infectious dose” is the number of microbial cells that cause an acute infection in humans. E.g. certain *Vibrio cholerae* strains cause a disease when ingesting only 10 cells, whereas with some *Escherichia coli* strains, $>10^6$ cells are needed “per os” for disease induction.

In the laboratory, researchers, assistants and students are exposed to the highest risk; however, one has to take into account the exposure of the cleaning, dishwasher and maintenance staff. The aforementioned laboratory workers are usually assumed to be healthy individuals in risk assessments. However, there are health status conditions, which increase the risk of infection. Different life phases, some (even chronic) diseases and the use of certain medications influence the host’s defence (e.g. pregnancy with the threat of foetal or congenital infection; allergic hypersensitivity, immunodeficiency caused by e.g. diabetes mellitus, cancer chemotherapy, etc.). Moreover, working in a laboratory can result in allergic reactions (e.g. to spore proteins of actinobacteria).

When talking about (microbiological) laboratory in its broadest context, an environmental microbiologist will also consider field trips, the collection and on-site investigation of samples in their natural environment. It is easy to imagine the risk of infection at a communal sewage treatment plant or at a waste deposition site, not to mention other obviously infectious events like the sampling of cadavers/carcasses.

2.1. Biological safety level categories and the airborne route of pathogen transmission

The grouping of microorganisms into four biological safety level (BSL) categories is mainly based on the severity of the disease they cause and their transmission route, since airborne transmission (i.e. transmission via aerosol) is the most difficult to control. Laboratory facilities and the required laboratory techniques and practices are similarly classified into four safety levels according to the agent. Organisms in BSL 1 are not known to cause any disease in healthy adults. Working with them needs practically no aerosol containment. BSL 1 facilities are adequate for teaching laboratories at post-secondary or undergraduate training level. In such laboratories, only a sink to wash hands for decontamination is required. Microbes in BSL 2 group are transmitted with ingestion, or via contact with mucous membranes (or by accidental self-injection), however their high concentration in aerosols may result in transmission (high infectious dose at droplet infection). Thus, in the case of working with such microbes, aerosol-

generating laboratory practices have to be contained with the use of an adequate biological safety cabinet (BSC). Personal protective equipment should be used when appropriate (laboratory coats, splash-protecting glasses and goggles, gloves, etc.). Naturally, washing hands for decontamination is a requirement. Adequate waste collection and decontamination facilities must be available (biohazard waste collecting bags and boxes, containers with microbicide liquid for used pipettes and other consumables, terminal decontamination autoclave, etc.). Microbes ranked as BSL 3 cause disease in humans and explicitly spread airborne (with low infectious dose). In this case, all of the activities with materials that are as much as suspected to be contaminated have to be performed in adequate BSC. Access to the laboratory must be controlled, and adequate ventilation systems are needed to minimise the risk of the release of infectious aerosols. Microbes or samples that are verified or only supposed to have a high risk of causing serious or even fatal disease in humans, independently of the transmission route, are categorized as BSL4. In BSL4 facilities, the highest-level BSCs are used or/and the laboratory personnel is protected by special ventilated suites.

Not only the microorganisms themselves and the infection pose biological hazard, but the metabolic products of the microorganisms are similarly of concern (e.g. toxins, biotransformation products, such as vinyl chloride). Special care has to be taken to control the (occupational) exposure to such compounds.

Special safety measures regulate biotechnological applications and the use of recombinant technologies especially when large-scale (> 10 L) applications are used. When considering recombinant techniques, well-characterized non-pathogenic hosts should be used, where the presence of incidental events can be excluded. Inserts should be similarly well characterized, free of “harmful” genes. Vectors should be as small as possible in size so they are unable to transfer DNA to wild-type hosts.

Since BSL categories strictly relate to the airborne pathogens and the airborne route of pathogen transmission, it is advisable to briefly summarize the ways by which aerosol is formed in laboratories. Most bacteria and yeast grown in the laboratory on solid media form butyrous cohesive masses, making it unlikely to form aerosol when the culture container is opened. On the contrary, sporulating (conidiospore-forming) bacterial and fungal colonies pose a hazard of spore aerosol formation for example with the mere opening of a Petri dish. For this reason, in the case of such cultures grown for prolonged periods, lids should be taped, not to be opened before prior examination for sporulation (presence of aerial hyphal forms), and should only be opened in BSCs. On the other hand, the manipulation of cultures like subculturing (e.g. the ignition of an inoculating loop), preparation of suspensions (by e.g. vortexing), centrifuging suspensions/broth cultures, pipetting, using blender type homogenizers, etc. are all procedures where small liquid droplets (aerosol) containing (infectious) cells (materials) may form. The larger particles (> 150 µm) readily drop, dry and form dust and thus contaminate bench top and floor surfaces. Particles smaller than 150 µm in diameter will most possibly evaporate before reaching the ground, forming “droplet nuclei”, which may hover for long periods. Droplet nuclei may even penetrate tissue facemasks. All microbes that are desiccation resistant (e.g. *Staphylococcus*, *Mycobacterium* spp., sporulating microbes) are of stressed importance since they remain alive for longer periods. Their UV tolerance further increases the risk of infection. It is recommended to work with the risk of aerosol/droplet nuclei formation in BSCs, and used contaminated materials (e.g. pipette tips, tubes) should be carefully submerged into disinfectant. The risk of formation of “droplet nuclei” containing infectious dust, especially necessitates the thorough, regular, disinfective cleaning of surfaces in a microbiological laboratory.

The prevention of aerosol formation is an important aspect in the development of good laboratory practice measures. Thus, when subculturing e.g. *Mycobacterium tuberculosis*, in spite of using ordinary loops and a gas burner, rather the use of electric incinerators or the application of disposable loops is required. Similarly, centrifugation (especially high-speed centrifugation) should be made in aerosol-proof safety tubes/containers, and even the rotors should be tightly covered.

2.2. The principle of containment, the setup and basic pieces of equipment of a microbiological laboratory

The conduct of work with infectious agents assumes the application of containment practices. Primary containment or primary barriers are the first line of defence encapsulating the infectious agent (animal, person, sample, etc.).

The culture vessel (e.g. a cotton-plugged test tube) is the primary containment to isolate (enclose) a(n) infectious culture. Opening the vessel intentionally (e.g. to subculture) or unintentionally (due to inadvertent handling) results in exposure, when other means of primary containment (e.g. directed air flow in a BSC, together with high-efficiency particulate air [HEPA] filter in the exhaust pipe or the charcoal filters built in the air path) will keep the agent as close to the site as possible. In the case of unintentional spill, infected surfaces need decontamination using prescribed techniques (disinfection protocols). Thus, primary barrier systems i. minimise the infectious volume, ii. ensure a safe environment for procedures with infectious agents, and iii. provide decontamination measures.

Primary containment is complemented with personal protective equipment (PPE) to further prevent human contact (e.g. skin contact, inhalation) with the agent. The most common personal protective equipment includes laboratory clothing (laboratory coats or body suits), aprons, gloves, eye protection, respiratory protection, head covers, shoe covers, etc. Adequate PPE should be selected to provide protection not only from biological hazards, but also to reduce the exposure to chemical and physical agents involved (e.g. toxic substances or radioactive material). To give an example, disposable rubber surgical gloves adequate to prevent contamination of the hands with infectious material are normally degraded by the solvent xylene, or do not protect from the carcinogenic DNA stain ethidium-bromide. Thus, in such cases, nitrile gloves should be selected. Another example is that disposable polyester “wrap around” gowns, due to their continuous solid front, give adequate splash protection but the material will melt on contact with heat. 100% cotton laboratory coats are flame resistant and nonreactive to many chemicals, but usually have front buttoning, leaving outdoor clothes exposed to contamination.

While primary barriers are designed to protect the personnel and the immediate laboratory environment from contamination, the elements of secondary containment protect the external environment of the laboratory from contamination. This can be achieved by a combination of facility design and operational practices.

Concerning facility design, the most important elements are simplicity and clarity, easy maintenance and operation. The allocation of adequate space to the planned operations on a long-term basis usually helps. The design of the building and of the laboratories should help keep hazards away from laboratory personnel, restrict the hazard to the smallest affected area, help the treatment of hazardous situations and clean up. Thus, microbiological research (and educational) laboratories should be physically clearly separated from ancillary laboratories (e.g. scullery, media preparation, sterilisation rooms), support rooms (environmental room, room for special instrumentation), storage rooms, and the administrative area, though positioned as close to each other as possible. Separate resting and eating facilities and male/female changing rooms/showers and toilets for the personnel should be available. Corridors must not be used as storage areas or as secondary laboratory workspaces. This is necessary not only to decrease contamination hazard, but also to meet fire rating criteria.

A typical two-window (two-module) laboratory is depicted in Fig. 1. There is enough space allotted for basic laboratory operations and for equipment (e.g. microscope, bench top centrifuges, water bath, PCR). The built-in cupboards below the benches, and the upper shelves and cupboards serve to store chemicals, laboratory vessels, utensils in immediate use (a laboratory is not a warehouse). There is a sink and a lavatory near the door, their door opens outside of the laboratory. Doors should be minimum 1 m wide to allow access of anticipated equipment. There is a BSC located where minimum external air currents are expected: furthest from the door and the heating/cooling fans.

BSL 3 and 4 laboratories have more strict design regulations (e.g. fixed windows, changing rooms with hygienic shower, separate access facility with two sets of doors for interchange, air lock systems, etc.) but these are out of the scope of this practical guide.

The finishing of surfaces in the laboratory is designed to be easy to clean. Walls, floors and ceilings should be water resistant. Utility (etc.) penetrations should be sealed or capable of being sealed. Care should be taken to prevent the surfaces from being continuously wet (e.g. because of vapour precipitation or dripping at refrigerators, sinks) since wet surfaces help (infectious) biofilm formation. Laboratory furniture should be compact, firm and durable, and stand on feet to help cleaning. Bench tops should be resistant to acids, alkalis, solvents and moderate heat.

Laboratory benches should include adequately mounted access to electricity (220/240 V and 360/400 V similarly), gas and water beyond the sink. Laboratory work is made extremely easy when there is a built-in, continuous access to pure (reagent grade) water (e.g. distilled or reverse osmosis treated water), cooling water, vacuum and space for the operation of chemical hoods or at least exhaust trunks (for working with toxic volatile/dusting chemicals). However, utilities have to be assembled with adequate traps to prevent the spread of infections (e.g. in centralized

vacuum systems). In extreme cases, rather special local appliances should be used. Chemical safety equipment includes emergency shower, eyewash stations, and vented storage for flammable/corrosive chemicals. When no adequate environmental rooms are available, storage equipment include incubators, refrigerators, and freezers (with temperature monitoring and alarm signals). Sterilisation equipment (autoclaves, dry air sterilisers, etc.) is of primary concern including also a dedicated instrument for terminal sterilisation of infected/contaminated materials before disposal.

Animal care facilities usually belong to the (micro)biological research/education environment. Even their basic setup falls out of the scope of this practical guide.

Microbiological laboratories should best be separated from areas with unrestricted access in the building. Controlled access using card-key electronic monitoring of laboratory sections is optimal. Moreover, care should be taken at the design of ventilation and air conditioning systems of microbiological laboratories. First, these systems should be adequately separated not to transmit contaminated air to the environment and to control cross-contamination among laboratories; second, air currents should not disturb safe laboratory practices. Laboratories should have adequate waste-handling and disposal provisions and regulations (including transitional storage and handling of general waste, biomedical waste, infectious waste, chemical waste, etc.). Vermin and rodent control are part of the management routine.

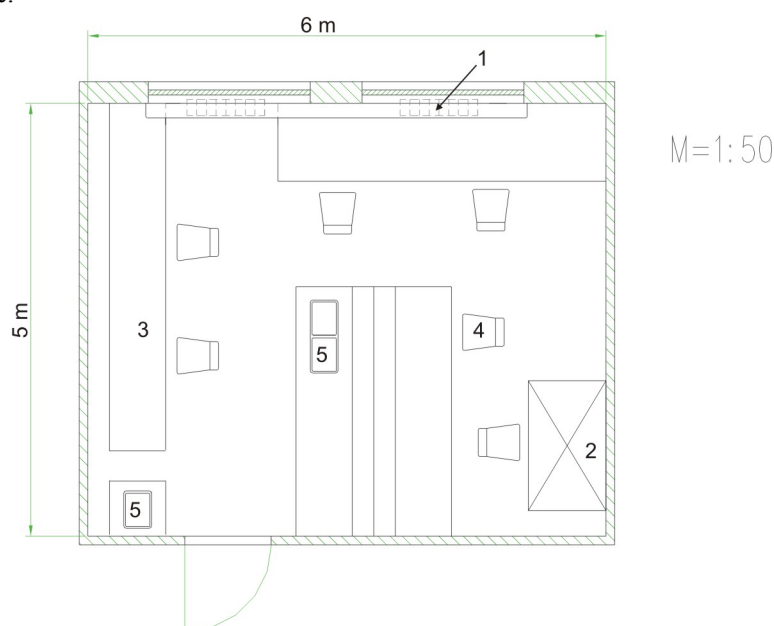

Fig. 1. Microbiological laboratory layout. Typical microbiological laboratory with ideal location of biological safety cabinet: 1. heating/air diffuses, 2. biological safety cabinet, 3. table, 4. chair, 5. sink.

2.3. Biological safety cabinets

In the early times of microbiology, the most dangerous (i.e. techniques with aerosol formation) microbiological laboratory operations (like subculturing, handling suspensions, centrifuging, etc.) were restricted to separated chambers within the laboratory, supplied with UV air disinfection (“inoculating rooms”), as a form of primary containment. Increased efforts to strengthen chemical laboratory work safety led to the development of safety hoods. Parallel efforts to protect against (micro)biological exposure led to the development of BSCs (a closed cabinet designed for easy decontamination, with a view screen protecting from splashing and splintering, and continuous air flow through the cabinet with exhaust decontamination). Today, BSCs are manufactured in three general classes, and are combined with HEPA filters, providing clean (“particle free”, near-sterile air) work benches due to laminar airflow. The use of HEPA filters assumes the presence of internal fans in BSCs to provide adequate, directed airflow in the cabinet. BSCs may be ducted (connected to an exhaust) or not ducted. Exhaust air is usually similarly decontaminated with the use of HEPA filters; and in some instances, activated carbon filters may be built into the internal and/or exhaust air stream to adsorb toxins or other hazardous biological/chemical agents.

Chemical hoods are built to protect the worker and the environment (air current, and exhaust filtration/dilution). BSCs equipped with HEPA filters similarly protect the product/biological procedure (aseptic/sterile operation in the workspace) and provide primary containment (keeping contaminated air in the cabinet).

Class 1 cabinets protect only the operator, but give no protection to the product/procedure. Laboratory air is sucked through the cabinet and the apparatus is equipped with a decontaminated exhaust (with HEPA/activated carbon filters) to the environment. It has to be mentioned at this point that horizontal-flow clean-air benches often used in biological laboratories to protect the product/procedure (e.g. cell culture) provide no operator protection; on the contrary, it may expose the operator to infectious, toxic, allergenic etc. materials deriving from the product. Such devices are not suitable in microbiological laboratories!

Non-ducted class 2 cabinets with HEPA filtered exhaust air fed back into the laboratory are the most common in BSL 1 and 2 microbiological laboratories. These provide protection to the operator and the work simultaneously. In case of class 2a cabinets, the air-blower recirculates 70 % of the air through a HEPA filter into the workspace, while 30 % is forced through another HEPA filter back into the laboratory air. On the suction side, 30 % fresh air enters at the fringe of the workbench (with 0,4 m/s inflow velocity) preventing the contamination of the laboratory, together with 70 % contaminated air from the workspace. This way, the cabinet provides through the HEPA filter a downward particle free (nearly sterile) laminar air stream over the work-bench, and maintains a continuous air intake through the opening of the view window/work opening (which should not be higher than 20-30 cm during work). The cabinet is sensitive to the disruption of the vertical laminar airflow by objects or devices causing turbulence. E.g. the upward airflow caused by gas burners can cause faults, as can the littering of the workbench with unnecessary objects.

Class 2b BSCs maintain a higher fringe inflow air velocity (0,5 m/s), and have ducted exhaust outside the building. This class BSCs have several subtypes, including also total exhaust cabinets for work with carcinogens.

Class 3 BSCs are maximum containment instruments used in BSL4 laboratories. They are e.g. ducted glove boxes with HEPA filtered clean-air workbenches, where materials are transferred into the work area through an interchange.

The workspace of the BSC is usually equipped with UV lamps, which enable disinfection at layoff, and have optional access to public/laboratory services (gas, vacuum, pressure air, water, etc.) They are constructed leak-proof, of corrosion resistant materials to withstand the chemicals generally used, and the terminal decontamination with formaldehyde vapour at filter change, and other service/repair operations.

BSCs, or very clean areas may be built around equipment with contamination hazard (e.g. high-speed centrifuges, fermenters, autoclaves, blenders, animal experiments).

2.4. Behaviour and work in a microbiological laboratory

Good laboratory practices with responsible behaviour at work can prevent most work-related exposures to infectious agents. The basic biosafety practices, compulsory at biosafety level two laboratories and recommended at biosafety level one, are as follows.

- Students should get appropriate training on the potential hazards and prevention measures at the start of the laboratory course, which should be refreshed when applying techniques of (infection) risk. For laboratory personnel, entry training and annual updates are necessary (e.g. policy changes, additional training). Training should be documented.
- Access to the laboratory is limited to formal students and laboratory personnel, especially when work with cultures is in progress. Persons who are at increased risk of infection (e.g. pregnant women, nursing mothers, immunocompromised people) may be excluded from laboratory work.
- Use 100% cotton laboratory coat/wrap-around gown, and/or other personal protective equipment. Gloves should be worn, particularly when the skin on the hands is injured. Laboratory safety glasses, face shield, aprons should be worn when appropriate. Comply with the indication of the laboratory supervisor! Personal protective equipment and clothing should be removed and left in the laboratory before leaving to non-laboratory areas. Protective clothing is either disposed of or laundered in the department/institution.

- Confine long hair and loose clothing. Wear closed shoes in the laboratory. Nails should be kept clipped and neat.
- Do not work alone in the laboratory if the conducted procedures are hazardous. Always make a work plan when working with hazardous materials. Always handle infectious materials with extreme care. Respect the requirements of the spill control and clean-up instructions. All procedures should be performed carefully to minimise aerosol formation.
- Decontaminate the workbench before and after work.
- Do not pipette by mouth, use pipetting devices. Do not drip contents from the pipette, touch a surface with the tip instead to let the contents slowly run out. When pipetting infectious material, do not “blow out” the pipette (tip). Avoid the use of sharp objects (syringe, needles, broken glass, scalpels, etc.)
- Do not speak when working with cultures, and do so only when necessary. Avoid practical jokes or other confusing behaviour, which may distract other students/personnel.
- Wash your hands regularly (especially following work). Do not eat, drink, smoke or apply cosmetics in the laboratory; do not take pen and ink or any other objects into your mouth. Do not store food in the laboratory. Do not handle contact lenses in the laboratory. Persons wearing contact lenses should wear eye protection (protective safety glasses/goggles).
- Cultures, stocks and wastes should be decontaminated (e.g. autoclaving) before disposal. Materials decontaminated outside the (teaching) laboratory should be collected in leak-proof well-built containers, and closed for transport to the decontamination site (autoclaving).
- Spills and accidents should be immediately reported to the laboratory supervisors.
- Chemicals and equipment should be always properly labelled and the work area should always be kept tidy, not cluttered. Place items in use in the logical order of the applied procedure.
- Aseptic work with cultures in a microbiological laboratory is practically always performed with gas burners on. The opening of glass culture vessels, metal caps, etc. are flamed between operations.

Be aware that in a microbiological laboratory, an extremely broad range of chemical hazards is represented because of the variety of chemicals used (solvents, acids, bases, carcinogens, mutagens, etc.). Be sure of the proper use of chemicals!

At laboratory/department level, a chemical inventory should be kept, and purchase should be based on real necessity. Minimise the use of hazardous chemicals. Material safety data sheets of chemicals should be readily available.

Only the most important basic laboratory and “chemical hygiene” measures are summarized below.

- Be aware of the safety hazard categories of the chemicals indicated by hazard warning and identity symbols on the containers (e.g. acutely toxic material, oxidising agent, inflammable material). Use only the smallest aliquots possible in the laboratory. Avoid skin contact with chemicals, do not smell vessels.
- When using electrically powered laboratory instruments, observe the directions for safe use!
- Provide appropriate ventilation, when working with volatile materials, use chemical hoods.
- Before commencement of work, locate the places of safety equipment in the laboratory (e.g. emergency shower, eyewash, first aid kit). Always respect the warning at areas/equipment where special protective equipment should be used!
- Do not discharge mercury and other heavy metal containing materials and flammable liquids into the sink. Comply with waste disposal regulations.
- Be extremely careful with hot instruments (autoclave, dry heat sterilisers, etc.) and when working with dry ice or liquid nitrogen. They may cause burns. Drying and ignition ovens, other hot plates should be operated over insulating underplates. Use adequate protective equipment when working with vacuum or pressure air (e.g. filtration).
- When using UV light (e.g. at DNA-based studies evaluated with transilluminators), always wear eye/face protection.
- Comply with the directions summarized on the instruction sheet when using special laboratory apparatus (e.g. autoclaves, centrifuges, vacuum drying apparatus). In case of doubt, ask the instructor!
- Comply with the regulations when using compressed gas cylinders. Cylinders should always be secured in an upright position. Do not store cylinders in the laboratory (when empty or not in use). Comply with the regulations related to the instrument (e.g. oxygen should never come in contact with grease and oil).
- In microbiological laboratories, working with open flame (gas burner/surface sterilisation by flaming with ethanol) is a daily routine. Keep flammable materials away from the flame!

- Emergency telephone numbers, location signs (exits, first aid equipment, , etc.), special warning signs (e.g. biohazard, use of UV protection masks) should be adequately posted.
- An adequate fire extinguisher must be available. Locate the location of the fire extinguisher in the laboratory, and get familiar with its use. In case of extensive fire, call the fire brigade, their number in Hungary is 105 or 112. Proceed as in section 2.4.3.
- When strong acid or alkali contaminates the skin, immediately rinse it with plenty of water. In the case of acids, use 3 % sodium-hydrogen carbonate (sodium bicarbonate) , in case of alkalis use 3 % boric acid solution to neutralise, and then wash your hands with soap or treat the burns (see 2.4.3.). If acid squirts into the eye, wash it by dropping with 2 % borax solution, then rinse with physiological saline. In the case of alkali, use 2 % boric acid, and then rinse with physiological saline. Apply bandage and consult an eye specialist.
- Work-related emergencies/accidents must be reported immediately to the supervisor. Accidents causing work drop-out should be reported to the person in charge of work-safety or the work safety director of the institution, and the case should be examined. In cases endangering human life, the spot of the accident should be left untouched for field inspection.

2.4 1. What to do in case of biological spill (involving BSL2 microorganisms)

- Alert people in the immediate area of the spill. Report to the laboratory supervisor.
- Put on protective equipment (e.g. gloves, eye protection, apron).
- Cover spill with adsorbent material (paper towel e.g.).
- Pour freshly diluted household bleach (1 to 10 dilution with water) carefully around the edges and onto the spill covered with adsorbent. Avoid splashing.
- Allow 20 minutes of contact.
- Collect the towels into a waste bag, and use fresh paper towels to wipe up the spill. Always wipe from the edges to the centre.
- Clean the area with general use laboratory disinfectant.
- Decontaminate the waste in an autoclave.

2.4.2. Decontaminating hygienic hand wash and personal decontamination

Always wash your hands before leaving the laboratory for any reason (end of work, eating/smoking, going to toilets, etc.) or when remaining in the laboratory, but finishing work in the BSC, or in case of contamination.

- First perform decontamination, usually by dispersing approx. 5 ml of skin disinfectant on your hands (take extra care of the interdigital areas) and lower arms (when needed) and leave it to for five minutes to be effective (check the prescribed action time; follow the directions of the instructor).
- Thereafter, carefully wash your hands (and lower arms) in warm water with soap.
- Wipe off water with paper towels or use blow dryer.

When other body surfaces get in contact with infectious materials, clothing should be removed, and the adequate part decontaminated according to the above-mentioned protocol. Skin injuries should be treated with adequate disinfectants (e.g. Betadine - a polyvinyl-pirrolidon iodine complex). With deeper injuries, the person should immediately consult a surgeon. Contaminated clothing should be soaked in disinfectant or subjected to other decontamination procedure (e.g. autoclaving).

When infectious material gets into the eyes, do not rub. Eyes should be rinsed immediately using lukewarm tap water or physiological saline. In the case of presumed injury, immediately consult an eye specialist.

In the rather unlikely situation of contamination of the mouth with pathogenic microbes, immediately spit it out into the sink or a handkerchief. Rinse the oral cavity several times with water, then gargle using freshly prepared 1 % aqueous hydrogen peroxide solution for 1-2 minutes. Mouth/throat lozenges may also be used. When there is suspicion of swallowing, a teaspoonful of meat extract powder should be slowly dispersed in the mouth and then swallowed. Then approximately 8-10 ml of 10 % aqueous hydrochloric acid solution should be applied. Do not drink water! The intensive protein digestion in the stomach might kill microbes. Consult a physician! In case of

toxic substances, take activated carbon tablets dispersed in water and immediately call emergency (see section 2.4.3. Poisoning).

2.4.3. Emergency and first aid guide

The laboratory should have a first aid kit in a marked location close to the lavatory sink. Recommended contents incorporate: sterile bandage (adsorbent gauze, crepe bandage, adhesive bandage, compression bandage, etc.), scissors, medical tape, disposable gloves, resuscitation pack, Betadine, activated carbon tablets, aqueous hydrochloric acid solution (10%), 2 m% boric acid solution in dropper dispenser, 2 m% borax solution in dropper dispenser, 3 m% sodium hydrogen carbonate solution, 3 m% boric acid solution, meat extract powder.

In case of emergency, remain calm. Alert classmates to evacuate the area, inform the instructor/local rescue personnel. In severe cases, initiate life saving measures.

Call for emergency/ambulance. In Hungary, call 104 or 112. When talking to the emergency/ambulance personnel:

- first, give your name, and the telephone number from which you are calling,
- indicate the exact location, and give help how to reach it on the campus/within the building,
- describe briefly but correctly the number of victims, the emergency conditions, the condition of the victim (conscious or not, bleeding, burned, pains, etc.),
- give indication if there is a need for the fire brigade (in this case you do not need to call them separately, the ambulance personnel will alert them),
- do not hang up, you can ask for first-aid instructions over the telephone; moreover additional information may be needed.

Burns

First, stop the fire with a blanket. The person in trouble can even drop to the floor and roll. Burned areas should be covered with moist, cool compression or held under running cold water (e.g. a burnt finger) until the ambulance arrives. If the victim is unconscious, i. check for breathing; ii. open the mouth by tilting the head back, and iii. start lifesaving by mouth - to - mouth ventilation.

Different chemicals can cause burns, too. In case of liquids, pour water abundantly on the burned area, and remove contaminated clothing. Keep on rinsing until the rescue personnel arrives. In case of burns caused by dry chemicals, first sweep the chemical off the clothes, then remove clothing from the affected areas and start cooling the burnt area by applying cold water as above.

When there is an electric shock, first switch off electricity. (When it is not possible, disengage the victim using insulating, e.g. wooden, plastic objects.). Then treat burnt areas as above.

Extremely cold objects/liquids (e.g. liquid nitrogen) cause frostbite. Carefully remove clothing from the affected area and immerse the injured part in lukewarm water (~40°C). Cover rewarmed parts with dry sterile gauze layers.

Bleeding

Warning! Always wear disposable gloves when treating a bleeding person or getting in contact with objects contaminated with blood or ooze, etc! Adequate decontamination procedures should be applied with such polluted clothing, etc. Use e.g. water diluted household bleach (10:1) and apply for an hour before continuing clean-up.

In the case of external bleeding, apply continuous firm pressure on the wound using e.g. sterile adsorbent bandage, or even with your gloved hands. Concurrently, turn the victim in a position where the place of bleeding can be raised above his/her heart. In the case of extensive bleeding, lay the victim down and raise his/her legs to approx. 30 cm. Do not give food or drink!

Internal bleeding can be a similarly life-threatening problem. Coughing or vomiting blood (or the presence of blood in the urine/faeces) are signs of internal bleeding. Lay the victim down and raise his/her legs to approx. 30 cm. Do not give food or drink!

Poisoning

If a person is suspected to have swallowed poisonous substance, immediately call the ambulance (and/or in Budapest, call the Clinical Toxicology Department of "Péterfy Hospital"; phone: +36-1-3215-215) and ask for help. If the person is unconscious, lies and vomits, turn him/her on the side and empty the mouth and throat from the vomitus. Concurrently, check for breathing! If there are no signs of breathing, start ventilation using a respiratory balloon and mask. Keep all objects and materials that may help in identifying the poisonous substance.

Seizure

Different causes may lead to seizure (e.g. poisoning, high fever, epilepsy). During seizure, protect the victim from injuries. Loosen his/her clothing. Lay the victim down and turn him/her sideways. Speak to the victim and try to set him/her mind at rest. During a seizure, the victim may partially understand speech and can even be guided. Do not leave him/her alone. During seizures, there might be intermissions in breathing. If the person does not resume breathing, apply ventilation as with an unconscious person (see below).

Choking

The occlusion of the respiratory tract for 3-4 minutes is a life-threatening situation.

If the choking person can speak and is coughing, do not interfere. When the choking situation does not resolve, administer 3-5 forceful blows between the victim's shoulder blades. Remove food bites or remains from the mouth. If this does not help, stand behind the victim and fold your hands below his/her chest. Exert abrupt epigastric pressure by thrusting the victim up and backwards. If there is no relief, repeat the two above interventions alternately.

If the person gets unconscious, help him/her to the floor, turn him/her to the side, and continue administering blows between the shoulder blades. Remove food bites or remains from the mouth. Then turn the victim on his/her back, kneel over the victim, and quickly apply pressure on the breastbone two to four times.

Unconscious condition

Unconsciousness - as it is also seen above - may be caused by different diseases and injuries. Unconsciousness refers to a state when respiration and circulation function, but it is impossible to establish contact with the victim. First try to establish contact by shouting at him/her, or (in case of no indication of spinal injury) by shaking the shoulder. Stabilize the status of the person (respiration and circulation) by mouth and pharyngeal toilette, turn the victim on the side and cover him/her in order to keep him/her warm. Open the airways by carefully lifting the neck of the victim.

Check repeatedly for breathing by listening for breathing sounds and observing chest movements. Check for pulse by placing gently two or three fingers on the neck on the side of the Adams' apple. In case the person is not breathing, start ventilation using a respiratory emergency kit.

If the pulse is absent, immediately call a properly trained person to apply external cardiac compression. There is a Semi-Automated External Defibrillator available at the "Northern Reception Desk" of Eötvös University, Faculty of Science Campus, Building South. Follow the instructions of the defibrillator apparatus, and continue cardiac compression/ventilation until the ambulance rescue personnel arrives.

Heart attack

The signs and symptoms of a heart attack include i. pressing chest pain; ii. impeded respiration; iii. full sweating; iv. nausea or vomiting; v. dizziness, feeling faint, weakness; vi. anxiety.

If any of these symptoms occur, call the ambulance immediately. In the meantime, loosen clothing and reassure the person that help is on its way. Position the victim into a half-sitting position to help breathing.

If the person gets unconscious, control breathing and circulation. Immediately call a properly trained person and apply the Semi-Automated External Defibrillator (see above).

Chapter 3. STERILISATION AND DISINFECTION

3.1. Procedures of sterilisation

Sterilisation refers to the anti-microbial process during which all microorganisms are killed or eliminated in or on a substance by applying different processes.

Microbes react in their own way to the antimicrobial effects of various physical treatments or chemical compounds, and the effectiveness of treatments depends on many other factors as well (e.g. population density, condition of microorganisms, concentration of the active agent, environmental factors). Sterilisation procedures involve the use of heat, radiation or chemicals, or “physical removal” of microbes. The type of sterilisation should always be chosen as required, by taking into consideration the quality of materials and tools used and the possible adverse effects of sterilisation on them.

3.1.1. Sterilisation by heat

The use of dry heat is based on the removal of the water content of microbes and subsequent oxidation.

Open flame can be used for sterilisation if the object is not directly exposed to flame damage. Different laboratory devices (e.g. scalpel, knife, inoculating loop or needle) can be sterilised quickly and safely by crossing over open flame or by ignition.

Dry heat sterilisation is performed in a hot air steriliser. It is an electric box with adjustable temperature like an incubator. In order to achieve uniform chamber temperature, hot air is circulated. Sterilisation with dry heat is limited to devices made of metal, glass or porcelain, and other thermo-stabile-materials, like glycerol, soft paraffin, oils and fats. In the dry heat sterilisation system they have to withstand the temperature needed to kill the spore-forming bacteria (at 160°C for 45 minutes; at 180°C for 25 minutes; at 200°C for 10 minutes).

The heat conductivity of water is several times higher than that of the air, therefore heat sterilises more quickly and effectively in the presence of hot water or steam than dry heat.

Boiling is the simplest and oldest way of using moist heat. The temperature of boiling water does not exceed 100°C at normal atmospheric pressure. Heat resistant, endospore-forming bacteria can survive the 10-30-minute heat treatment of boiling, so no sterilizing effect can be expected from boiling.

Pasteurisation is a widespread method – named after Louis Pasteur – to reduce the number of microorganisms found in different heat sensitive liquids. Milk can be pasteurised by heating to 65°C for 30 minutes or to 85°C for 5 minutes. During ultra-pasteurisation milk is heat-treated at 135-150°C for 2 minutes in a heat exchanger. The temperature and time used for pasteurisation are suitable to control the presence of some pathogenic bacteria, however endospores and cells of heat resistant bacteria e.g. *Mycobacterium* species, can survive.

Tyndallisation (intermittent sterilisation) is an old and lengthy method of heat sterilisation named after John Tyndall. During this method, a medium or solution is heated to a temperature over 90°C for 30 minutes for four successive days, and the substances are placed in an incubator at 37°C or stored at room temperature in the intermittent periods. Vegetative forms are destroyed during the heat treatments. Endospores which can germinate during the incubation period are destroyed during the consecutive heat treatments. This way, after the fourth day of heat treatment, no living cells remain in the substance.

EXERCISE 1: OPERATION OF THE AUTOCLAVE

The use of saturated steam under high pressure is the most effective method to kill microorganisms. In the laboratories, a sealed heating device called autoclave is used for this purpose (Fig. 2). From the inside of the carefully temperature-controlled autoclave, the air is expelled by the less dense steam and sterilisation takes place in a closed chamber at 121°C and overpressure. The household pressure cooker works on a similar principle but with lower

temperature. Autoclaves are widely used in microbiological practise mainly for sterilisation of culture media, glassware and heat-resistant plastic products before their use, and also for contaminated materials prior to disposal as municipal solid waste. To achieve sterilisation, generally 15 minutes of heat treatment at 121°C under 1.1 kg/cm² pressure has to be applied. Most microbes are unable to tolerate this environment for more than 10 minutes. However, the time used for sterilisation depends on the size and content of the load.

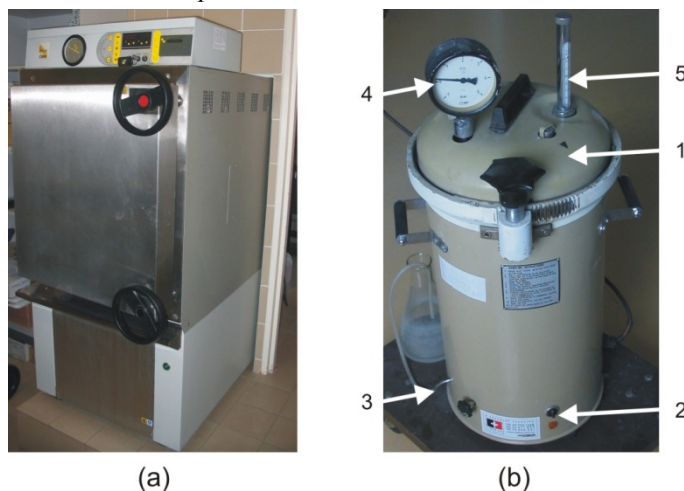

Fig. 2. Sterilisation by heat – the autoclave. (a) Bigger, automatic autoclave operated by external steam afflux. (b) Smaller, manual autoclave: 1. lid, 2. power switch, 3. bleeder valve, 4. pressure gauge, 5. thermometer.

Object of study, test organisms:

culture medium in a flask

Materials and equipment:

distilled water
heat-proof gloves
autoclave

Practise:

1. Open the lid of the autoclave and check that there is sufficient amount of distilled or deionised water in it. If necessary, refill.
2. Place the correctly packaged materials (e.g. laboratory equipment, culture medium in a flask) into the chamber of the autoclave. Stick a piece of autoclave indicator tape onto the surface of materials!
3. Close the lid of the autoclave.
4. Make sure that the bleeder valve is open.
5. Turn on the heating of the autoclave (the indicator lamp is lit).
6. If an intense (a thick, milky white) steam outflow can be detected through the outlet tube of the bleeder valve (100°C on the built-in thermometer), wait for 4-5 minutes and close the bleeder valve (venting).
7. With the help of a built-in thermometer and manometer, check the temperature and pressure increase inside the chamber of the autoclave.
8. The sterilisation time (15 minutes or more) begins only when the temperature equalization (to 121°C) in the chamber has occurred. It is important that the operator stays with the device and controls the process of sterilisation from the time it is turned on until the end of the sterilisation period.
9. Turn off the power switch of the autoclave when the sterilisation cycle/period has ended.

10. Allow the device to cool down to at least 60-70°C.
11. For decompression, slowly open the bleeder valve. Thereafter, carefully open the lid of the autoclave and remove the sterilised materials, using heat-proof gloves. Check the colour of sterilisation indicator controls.

3.1.2. Sterilisation by radiation

Other forms of energy [e.g. ultraviolet (UV) and ionizing radiation] are also used for sterilisation especially for heat-sensitive materials. The full spectrum of UV radiation can damage microbes but only a small part is responsible for the so-called germicidal effect. Very strong "germicidal" effect can be achieved around 265 nm, because maximum UV absorption of DNA occurs at this wavelength. The main cause of cell death is the formation of pyrimidine dimers in nucleic acids. Bacteria are able to repair their nucleic acid after damage using different mechanisms; however, beyond a certain level of damage, the capacity of the enzyme system is not enough and the accumulation of mutations causes death. UV (germicidal) lamps are widely used in hospitals and laboratories (e.g. in biological safety cabinets) for decontamination of air and any exposed surfaces. The disadvantage of the use of UV radiation is that it does not penetrate through glass, dirt films, water, and other substances.

Among the high-energy ionizing radiation, γ -rays from radioactive nuclides ^{60}Co are generally used for sterilisation of disposable needles, syringes, bandages, medicines and certain food (e.g. spices). The advantage of gamma radiation is its deep penetration through the packaging. Its disadvantage is the scattering in all directions, which requires special circumstances for application.

3.1.3. Filter sterilisation

The most commonly used mechanical method of sterilisation is filtration (Fig. 3). During filtration, liquids or gases are pressed through a filter, which (depending on its pore size) retains or adsorbs (e.g. asbestos filter pads) microbes, thereby the filtrate becomes sterile. The pore diameter of filters should be chosen carefully so that bacteria and other cellular components cannot penetrate.

Earlier Seitz-type asbestos or different glass filters were commonly used for the filtration of microorganisms. The modern membrane filters are usually composed of high tensile-strength polymers (cellulose acetate, cellulose nitrate or polysulfone, etc.). Their operation is based partly on the adsorption of microbes, partly on a mechanical sieve effect. The pure sieve-based filters can be beneficial because they do not change the composition of the filtered solution. To remove bacteria, membrane filters with pore size of 0.22 μm are the best choice.

Membrane filters are biologically neutral; do not hamper life activities of microorganisms remaining on the filter and do not inhibit their enzyme functions. Furthermore, nutrients can diffuse through the membranes, so bacteria can be cultured on a variety of media also by placing the filters onto their surface.

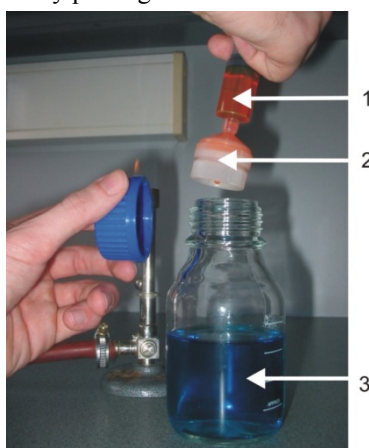

Fig. 3. Filter-sterilisation using syringe filter. Vitamin-solution (1) is added with filter-sterilisation (2) to the presterilised medium (3).

3.1.4. Sterilisation by chemicals

A wide range of chemicals is suitable to inhibit or kill microbes. Some of the antimicrobial agents only inhibit the growth of microorganisms (e.g. bacteriostatic, fungistatic, and virostatic compounds) while others kill them (e.g. bacteriocidal, fungicidal, and virocidal agents). The -static or -cidal effect of a substance depends on the applied concentration and exposure time in addition to its quality. Only -cidal effect substances are used for chemical sterilisation. These substances have the following requirements: they should have a broad-spectrum effect, they should not be toxic to higher organisms, they should not enter detrimental reactions to the materials being treated with, they should not be biodegradable, they should be environmentally friendly, easy to apply and economical.

The materials used in chemical sterilisation are liquids or gases. Liquid agents are used especially for surface sterilisation. Among sterilising gases, those working at low temperature function by exposing the materials to be sterilised to high concentrations of very reactive gases (e.g. ethylene oxide, beta-propiolactone or formaldehyde). Due to their alkylating effect, these compounds cause the death of microbes by damaging their proteins and nucleic acids. The chemical agents used for sterilisation must be chemically compatible with the substances to be sterilised, therefore they have a great importance in sterilisation of pharmaceutical and thermoplastic materials. The chemicals used by the gas sterilisers are harmful to humans as well. Therefore, the application of gas sterilisers requires compliance with the precautions by the users.

3.2. Procedures of disinfection

Any process aimed at destroying or removing the infectious capability of pathogenic microbes that generally occur on inanimate objects, is called disinfection. The chemicals used for disinfection can be classified according to their chemical structure and their mode of action.

Among the alcohols, ethanol and isopropanol are widely used as disinfectants. 50-70% aqueous solution has excellent antiseptic properties. The action mechanism of alcohols depends on the applied concentration. Due to the solubility of lipids in 50-95% ethanol solutions, biological membranes are disintegrated. Alcohols pass through the cell membrane with altered permeability, denature the proteins inside the cell and have a dehydration effect as well. Absolute alcohol (100% ethanol) provides the best dehydration effect but does not coagulate the intracellular proteins. 70% dilution of alcohols is the most effective way to kill the vegetative forms of bacteria and fungi, but less effective against spores and lipid-enveloped viruses.

Phenol called carbolic acid was first used as a disinfectant by Lister. Phenol denatures proteins, and irreversibly inactivates the membrane-bound oxidases and dehydrogenases. Due to the unfavourable physical, chemical and toxicological properties, phenol is no longer used. However, substituted (alkylated, halogenated) derivatives are often used in combination with surfactants or alcohols (e.g. cresol, hexachlorophene, chlorhexidine).

The halogens (F, Cl, I, Br) and their derivatives are very effective disinfectants and antiseptic agents; mainly their non-ionic forms have antimicrobial activity. Chlorine gas is used almost exclusively for the disinfection of drinking water or other waters. In addition, different compounds (e.g. chloride of lime, chloramine-B, sodium dichloroisocyanurate) are among the most widely used disinfectant agents. Sodium hypochlorite ("household bleach" is a mixture of 8% NaClO and 1% NaOH) is one of the oldest high-bleaching and deodorizing disinfectant. The basis of the effect of chlorine and its derivatives is that during decomposition in aqueous solution, a strong oxidant, nascent (atomic state) oxygen ('O'), is released. Nascent oxygen is very reactive and suitable to destroy bacteria, fungi and their spores as well as viruses.

Iodine is also a widely used disinfectant and antiseptic agent. There are two known preparations: tincture of iodine (alcoholic potassium iodide solution containing 5% iodine) and iodophors (aqueous solutions of iodine complexes with different natural detergents). It is applied in alcoholic solution to disinfect skin or in aquatic solution for washing prior surgery.

Aldehydes, such as formaldehyde and glutaraldehyde, are broad-spectrum disinfectants. They are used for decontamination of equipment and devices. Formalin is the 34-38% aqueous solution of formaldehyde gas. Its effect is based on the alkylation of proteins.

Heavy metals such as mercury, arsenic, silver, gold, copper, zinc and lead, and a variety of their compounds are highly efficient disinfectants but they are too damaging to living tissues to apply. They can be used as disinfectants

at very low concentrations. Inside the cell, they bind to the sulfhydryl groups of proteins. Primarily, organic and inorganic salts of silver and mercury-containing products are commercially available, which have bactericidal, fungicidal and virocidal effect.

Detergents or surfactants are amphiphilic organic molecules which have a hydrophilic "head" and a long hydrophobic "tail". Detergents can be non-ionic, anionic or cationic according to the charge of the carbon chain. Nonionic surfactants have no significant biocidal effect and anionic detergents are only of limited use because of their poor efficiency. The latter group includes soaps, which are long-chain carboxylic acids (fatty acids) of sodium or potassium salts. They are not disinfectants on their own, but are efficient cleaning agents due to their lipid-solubilising effect. Cationic detergents, such as quaternary ammonium salts, are the best disinfectants.

3.3. Control of the efficacy of sterilisation equipment

To monitor the efficacy of sterilisation equipment, several methods are available: instrumental monitoring, the use of chemical indicators and biological monitoring with spore preparations.

By instrumental monitoring, the vapour pressure, temperature and exposure time can be monitored inside the sterilizing equipment. In general, colour changes of chemical indicators on packaging show that temperature and duration are sufficient for effective sterilisation. The original Browne-type sterilisation control glass tubes contain a red indicator solution, which turns yellow during inadequate heat treatment, and turns green in the case of sufficient sterilisation. Another chemical indicator, the indicator tape, should be stuck onto the outer surfaces of the load (e.g. glassware or aluminium foil packaging). The strips change colour or a marking appears (e.g. "OK" or "STERILE"), which indicates that sterilisation has taken place. The use of chemical indicators is recommended only in equipment previously qualified by biological tests.

The use of biological indicators is the most reliable method for the certification and periodic monitoring of sterilizing equipment. For this purpose, standardised bacterial spore products, the so-called "spore preparations" are required. Test organisms (e.g. spores of *Geobacillus stearothermophilus*) are usually more resistant to heat sterilisation than most microorganisms. If the efficiency of sterilisation is inadequate, test microbes remain viable (spore germination is maintained). For the microbiological control of steam sterilisers, standardised bioindicators made of the spores of the type strain of *Geobacillus stearothermophilus* ATCC 7953, containing 1.2×10^6 CFU equivalent endospores are used. This amount of spores can be destroyed by an efficient autoclaving cycle. The destruction or survival of microorganisms can be detected by culturing in broth. The spore preparations should be placed, equally distributed, with the load within the chamber of the autoclave at the characteristic technical points.

EXERCISE 2: MICROBIOLOGICAL CONTROL OF AN AUTOCLAVE BY USING THE SPORE PREPARATION OF *GEOBACILLUS STEAROTHERMOPHILUS* ATCC 7953

Object of study, test organisms:

spore preparation of *Geobacillus stearothermophilus* ATCC 7953

Materials and equipment:

TSB medium (see Appendix)
sterile scissors
sterile metal forceps
autoclave
Bunsen burner
incubator (set at 55-60°C)

Practise:

1. Place the spore preparation containing strips to the appropriate points of the autoclave chamber.
2. Conduct a sterilisation cycle in the autoclave. (See EXERCISE 1)

3. When the sterilisation cycle is completed, open the bags containing the spores with sterile scissors. Place the preparation of spores into sterile TSB medium aseptically using sterile forceps.
4. Incubate the broth containing the spores in an incubator at 55-60°C for a week.
5. After the incubation period, detect the presence of bacterial growth within the culture broth.

3.4. Determination of the microbiological efficacy of disinfectants

Microbiological laboratories, especially those involved in epidemiological, medical or industrial processes (pharmaceutical companies, food industry), use disinfectant solutions for preventive, continuous or terminal disinfection. In the case of an actual epidemiological event (epidemic, accumulation of infection), the effectiveness of these disinfectants is systematically inspected. The principle of efficacy testing is that the relevant disinfectant is incubated with a test bacterium for a defined time interval, and the treated bacteria are subsequently spread onto the surface of a suitable nutrient medium. Following the incubation period, based on the growth of the test microbe, conclusions can be drawn whether the disinfectant within the exposure time interval effectively killed the test microbe.

EXERCISE 3: DETERMINATION OF THE MICROBIOLOGICAL EFFICACY OF DISINFECTANTS

Object of study, test organisms:

- 24-hour culture of *Staphylococcus aureus* strain in 50 mL TSB medium
- 24-hour culture of *Pseudomonas aeruginosa* strain in 50 mL TSB medium
- 24-hour culture of *Bacillus subtilis* strain in 50 mL TSB medium

Materials and equipment:

- TSB medium (see Appendix)
- pipettes, sterile pipette tips
- vortex mixer
- water bath
- TSA plates (see Appendix)
- disinfectants: 1% and 2% sodium hypochlorite solution, other commercially available disinfectant (such as Domestos, Clorox)
- control solution: 0.9% sodium chloride solution
- sterile plastic inoculating loops
- 9 mL sterile distilled water in test tubes
- sterile test tubes
- Bunsen burner
- incubator

Practise:

1. Measure 9-9 mL from each adequately diluted disinfectant solution and from the control (NaCl) solution into sterile test tubes and place the test tubes into 25°C water bath (Fig. 4).
2. Place sterile plastic inoculating loops into the liquid cultures of the test microbes for 10 minutes.
3. Following the 10-minute incubation, take out the plastic inoculating loops, drain the excess of the liquid culture by touching the inner side of the test tubes.
4. Place the “infected objects” in the appropriate disinfectant solution as well as into the control solution, and leave them there for predefined incubation periods (1, 5, 15, 30, 45 or 60 minutes).
5. Immerse the loops in sterile water for 1 minute (to remove the remaining disinfectant from the surface of the inoculating loop).

6. Inoculate the surface of the TSA plates with the plastic inoculating loops.
7. Place the infected agar plates into an incubator at 28°C for up to a week.
8. Evaluate bacterial growth compared with the controls (0.9% sodium chloride solution that has not been inoculated, and one that has been inoculated with the test microbes) on a scale of five (-, □, +, ++, +++) (see Appendix for the evaluation table).

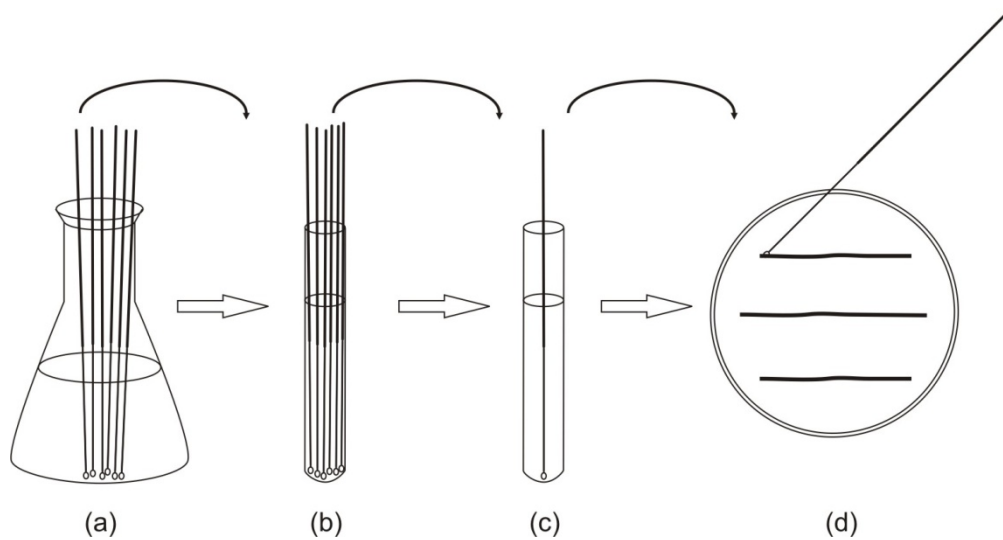

Fig. 4. Testing the efficacy of disinfectants. (a) Place sterile plastic inoculating loops into the suspension of the test microbes. (b) Place the “infected object” in the appropriate disinfectant solution. (c) Wash the loop in sterile water. (d) Inoculate the surface of the TSA plates with the plastic inoculating loops.

Chapter 4. SAMPLING METHODS IN MICROBIOLOGY

The way of sampling depends on the aim of the microbiological study, and must be done at the selected site with sterile equipment. Although sampling different environments (e.g. throat swab, blood, soil, sewage, water, etc.) require different methods and equipment, samples always have to be representative. Sampling must always be done in adequate number of parallels depending on the aim of the research. Not only sampling, but also the transfer of samples to the laboratory can be a critical point during the study. Recording details on site will help the interpretation of results later. Take extra care to avoid contaminating the sample container or the sample.

4.1. Sampling for diagnostic purposes

Sampling for diagnostic purposes and the successful diagnosis of pathogenic microbes needs professional sampling techniques and quick transfer of samples to the laboratory. Different methods are used for different samples (e.g. tissue, urine, feces, blood, etc.), but the amount of contaminating microbes in the samples (which possibly mask the original pathogens) must be low. Samples are always put into sample containers that are adequate for the given sample. Samples must be precisely labelled and transferred to the laboratory with care.

4.2. Sampling from various environments

4.2.1. Collection of air samples

Air sampling in the context of microbiological assessment is the collection of airborne microorganisms. The atmosphere is not a living habitat for microbes, but they can spread through it, and therefore the atmosphere could act as a conveyor of pathogenic microbes. Studying microbes in the air has not only hygienic but also economic importance: microbes present in the atmosphere of a factory can be hazardous to crude materials and products, and also to the production processes. Consequences of using microbiologically contaminated materials can be serious, therefore checking the quality of the air is a critical factor in the cosmetics, pharmaceutical and food industries, etc.

There are different ways for sampling the air. The simplest way is the passive, “Koch-type” sedimentation method (using settle plates), which is adequate to detect well settling microbial particles. Active methods require impaction devices (Fig. 5). The volume of air for active sample collection depends on the device being used and on the anticipated concentration of the bioaerosol. With filtration (selecting adequate pore size filters) or gas washers not only microbes (e.g. fungi, bacteria) but also cell debris can be detected. The use of impingement (slit sampler) is also widespread. In this case, in a narrow canal, an air stream is generated and particles are caught by breaking the way of the air.

Where only low concentrations of microbial contaminants are expected, e.g. clean rooms, food production facilities and operating theatres, generally impaction methods are chosen. In highly contaminated environments, impaction techniques may 'oversample' even in short timescales and impingement or filter samples are more appropriate. With the strict adherence to manufacturer's flow rates, sampling periods, culture media used and device placement, most techniques should yield comparable results, which are normally expressed in CFU/m³ of air (CFU= colony forming unit).

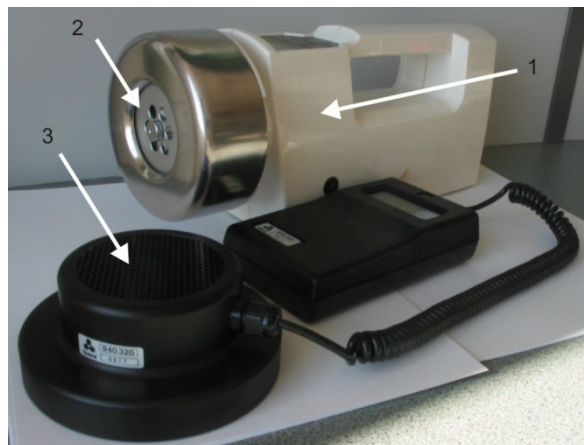

Fig. 5. Automatic impaction device for air sampling. 1. RCS Plus air sampler. 2. Autoclavable swivel with test medium stripe. 3. Anemometer to set the investigated air volume.

EXERCISE 4: ASSESSMENT OF THE MICROBIOLOGICAL AIR QUALITY OF THE LABORATORY WITH SEDIMENTATION

Object of study, test organisms:

atmosphere of the laboratory

Materials and equipment:

nutrient agar plate (see Appendix)
starch-casein agar plate (see Appendix)
incubator

Practise:

1. Place open Petri dishes (with adequate medium) to different locations in the laboratory and expose for 5, 10 and 15 minutes.
2. Close the Petri dishes and label them.
3. Put the Petri dishes into a 28°C incubator and incubate them for up to one week.
4. Count the colonies on the surface of the agar plates and compare with the results of different media, exposure times and sampling locations.
5. Compare the results with those obtained with other methods.

EXERCISE 5: ASSESSMENT OF THE MICROBIOLOGICAL AIR QUALITY OF THE LABORATORY WITH A MAS-100 OR WITH AN AES SAMPLE AIR-MK2 EQUIPMENT

In industry, usually volumetric air-samplers are used. Mas-100, AES Sample Air MK2, RCS Plus are the most widespread equipment types. The MAS-100 and the AES Sample Air-MK2 are strict flow cascade impactors, where air flows over a perforated sheet. The airflow containing “particles” is led to the agar surface of a Petri dish. The system measures and controls air inflow, the speed of which is 100L/min.

Object of study, test organisms:

atmosphere of the laboratory

Materials and equipment:

nutrient agar medium (see Appendix)

starch-casein agar medium (see Appendix)
 MAS-100 or AES Sample air-MK2 equipment
 incubator

Practise:

1. Position the Petri dish with the adequate agar medium into the equipment and take 250 L air samples from different parts of the laboratory with a MAS-100 or a AES Sample air-MK2 equipment.
2. Close the exposed Petri dishes and label them.
3. Incubate the Petri dishes at 28°C for up to one week.
4. Count the colonies on the surface of the agar plates and compare with the results from different samples. Observe the colony morphology of microbes on the agar surface.
5. Compare the results with those obtained with other methods.

EXERCISE 6: ASSESSMENT OF THE MICROBIOLOGICAL AIR QUALITY OF THE LABORATORY WITH RCS Plus EQUIPMENT

The RCS Plus equipment (Fig. 5) applies centrifugal impaction that produces airflow (containing particles and microbes) directed to the special, medium-containing plastic test strips. The impactor capacity is 50 L air/min.

Object of study, test organisms:

atmosphere of the laboratory

Materials and equipment:

medium-containing strips
 RCS Plus equipment
 incubator

Practise:

1. Sterilise the head of the equipment.
2. Slide the strips into the head of the equipment and take 250 L air samples from different parts of the laboratory with RCS Plus type equipment.
3. Take out and close the exposed strips and label them.
4. Incubate the strips at 28°C for up to one week.
5. Count the colonies on the surface of the strips and compare with results from different samples. Observe the colony morphology of microbes on the agar surface.
6. Compare the results with those obtained with other methods.

4.2.2. Collection of soil samples

Soil tests measure the microbial composition and activity of different soil horizons. The physicochemical characteristics of soil influence the rate of biomass production and the activity and composition of microorganisms. Seasonal changes in soil moisture, soil temperature and carbon input from crop roots, rhizodeposition (i.e. root exudates, mucilage, sloughed cells), and crop residues can have a large effect on soil microorganisms, which, in turn, affect the ability of the soil to supply nutrients to plants through the turnover of soil organic matter. Therefore, the collection of representative soil samples is extremely important and sampling should always be performed taking into account the above-mentioned heterogeneity associated with many soil types.

Sampling can be performed aerobically or anaerobically with sterile sampling equipment.

EXERCISE 7: SOIL SAMPLING FOR MICROBIOLOGICAL STUDIES

Object of study, test organisms:

soil

Materials and equipment:

spade
sterile spatula or ground sampling spoon
150 mL Erlenmeyer flask, closed with cotton plug
sterile syringe
sterile scalpel
anaerobic jar
cooler box

Practise:

1. Dig a standard soil profile with a spade and cut a fresh, uniform surface in the middle region of the adequate soil horizon, then remove blurred horizon surface and clean an untouched area with a sterile spatula.
2. In the case of aerobic sampling, take ca. 50 cm³ soil to a sterile Erlenmeyer flask with a sterile sampling spoon (avoid sampling soil animals or roots).
3. In the case of anaerobic sampling, cut the end of a syringe with a sterile scalpel and pull out the piston. Push the syringe cylinder into the soil horizon. Label this plug soil sample and put it into an anaerobic jar.
4. Cool (to 2-10°C) and transfer the sample(s) to the laboratory as soon as possible.

4.2.3. Collection of water samples

Sampling natural waters representatively is one of the biggest challenges to overcome. In flowing waters, the trail effect, in stagnant waters, stratification make representative sampling difficult. Moreover, coastal current and drifting also must be considered. Surface water samples are taken from 10 cm depth by submerging sterile sampling bottles. For the collection of samples from deeper zones, special equipment is used (Fig. 6). For collecting surface phytoplankton samples, a clean plastic bottle is adequate. For sampling water-conduit, sampling taps are used, where the water must run for 2-5 min before taking a sample. The rules for microbiological investigations and sampling are set in the EN ISO 19458:2006 standard.

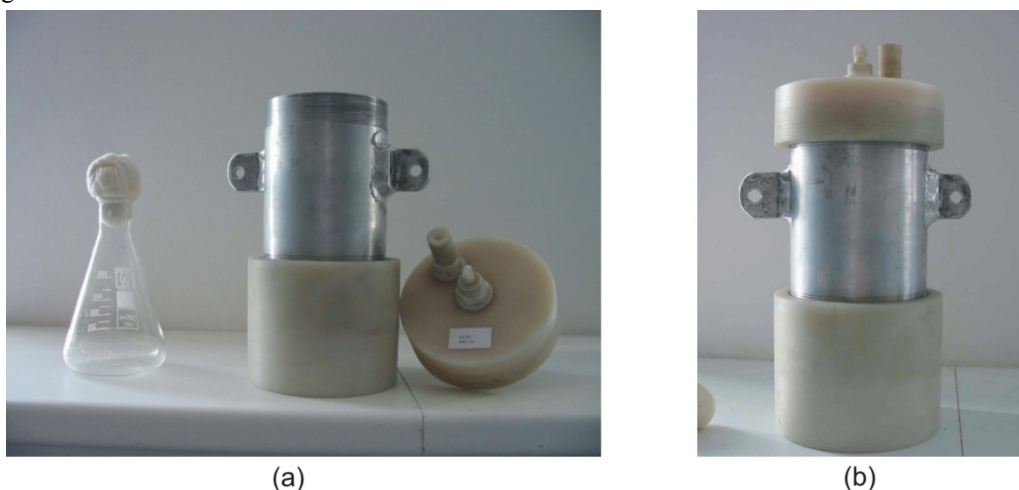

Fig. 6. Profundal water sampler. (a) Disassembled device. (b) Device ready for sampling (without cords).

EXERCISE 8: WATER SAMPLING FROM A RIVER OR LAKE

Object of study, test organisms:

surface water

Materials and equipment:

sampling rod
 250 mL sterile, narrow-neck Erlenmeyer flask, closed with cotton plug
 250 mL Meyer-flask (on plastic string)
 250 mL broad-neck Erlenmeyer flask
 cooler box

Practise:

1. Label the Erlenmeyer flasks (in this case: sample containers) prior to sampling.
2. In the case of sampling the shoreline from the bank, fix a sterile Erlenmeyer flask to the sampling rod. Take out the plug and immerse the flask 10 cm under the water surface. When the flask is half full of water, take it out and close it.
3. In the case of surface sampling take out the plug from the Meyer-flask (connected to plastic string) and throw it to the adequate place. When the flask is filled with water, pull it out and pour the sample into a sterile Erlenmeyer flask.
4. Cool (to 2-10° C) and transfer the sample(s) to the laboratory as soon as possible.

4.2.4. Sampling the surface of objects

Objects and surfaces can be sampled easily using a sterile cotton swab or with special sampling equipment (e.g. contact slide) (Fig. 7).

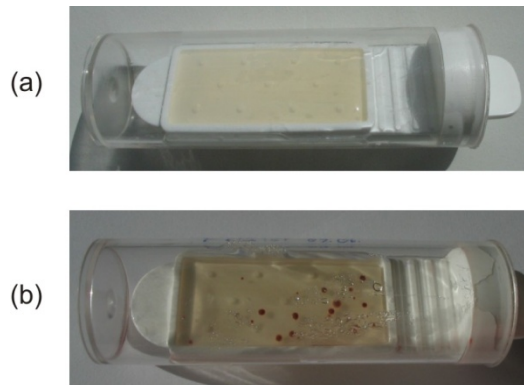

Fig. 7. Sampling surfaces. (a) Sterile contact slide before sampling. (b) Culture developed after sampling a door handle.

EXERCISE 9: SAMPLING SURFACES FOR MICROBIOLOGICAL CONTAMINATION

Object of study, test organisms:

surfaces, objects

Materials and equipment:

sterile, wet cotton swabs
 nutrient agar medium (see Appendix)
 starch-casein agar medium (see Appendix)
 contact slide
 incubator

Practise:

1. In case of bigger objects or surfaces, rub ca. 100 cm² area with a sterile cotton swab.
2. Inoculate the adequate agar plates with the cotton swab by spreading.
3. Label the Petri dishes.
4. In the case of using contact slides, open the closing foil and take out the slide from its container.
5. Press the slide (containing agar medium) to the surface for 5 sec. Replace the slide into its container.
6. Incubate Petri dishes and slides at 28°C for up to one week.
7. Count the colonies on the surface of different agar plates/slides and compare with the results obtained from different samples. Observe the colony morphology of microbes on the agar surface.
8. Compare the results with those of different surfaces.

(See also Supplementary Figure S13, 14.).

4.2.5. Hygienic control of the hands of operators

In many cases (e.g. clean spaces, in pharmaceutical and food production) low germ counts and environments free of pathogenic microbes are essential. This also includes the control of personnel. In such cases usually the palm and finger skin surfaces are sampled with cotton swabs or using contact sampling (Fig. 8). The efficacy of hand hygiene agents can also be tested using these methods.

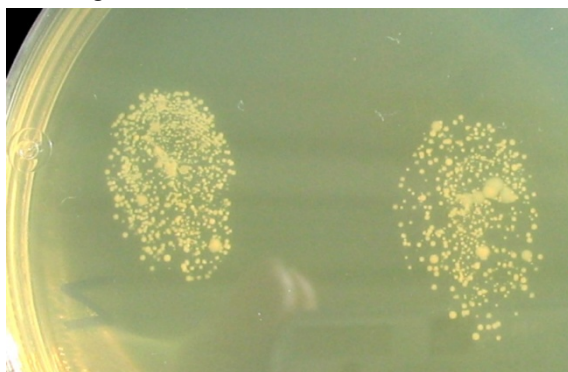

Fig. 8. Contact sampling finger skin surfaces. Fingerprint sample on nutrient agar.

EXERCISE 10: SAMPLING FOR MICROBES INHABITING SKIN SURFACES I.

Object of study, test organisms:

skin surfaces

Materials and equipment:

sterile, wet cotton swabs
 nutrient agar medium (see Appendix)
 starch-casein agar medium (see Appendix)
 incubator

Practise:

1. Rub the skin of your palm and fingers with sterile cotton swabs.
2. Spread agar plates with the inoculated cotton swab.
3. Incubate at 28°C for one week.

- Count the colonies on the surface of different agar plates and compare with the results from different samples. Observe the colony morphology of microbes on the agar surface.

EXERCISE 11: SAMPLING FOR MICROBES INHABITING SKIN SURFACES II.

Object of study, test organisms:

skin surface microbiota during washing hands with soap and disinfectants

Materials and equipment:

soap
disinfectant solution
nutrient agar medium (see Appendix)
starch-casein agar medium (see Appendix)
incubator

Practise:

- Divide the agar plate into three sections by marking it on the bottom of the Petri dish (1-3).
- Before washing hands, touch the surface of the agar medium with your thumb in section 1.
- Wash your hands carefully with soap and touch the surface of the agar medium in section 2 with the same thumb.
- Use a disinfectant for washing hands, then touch the surface of the agar medium in section 3 with the same thumb again.
- Incubate Petri dishes at 28°C for one week.
- Compare the colony counts of different sections, observe the colony morphology, and analyse the effect of hand washing.

Chapter 5. INTRODUCTION TO THE USE OF PRACTICAL LABORATORY MICROSCOPES

5.1. Bright-field light microscopy

In microbiological practice, microscope is one of the most important tools due to the micrometre order of magnitude of microorganisms. Parts of a light microscope involve the eyepiece (ocular), tubes, objective lens (or lenses, in a rotating revolver structure), stage, condenser, light source, scaffolding and adjustment screws (macro and micro screws) (Fig. 9).

A microscope is a compound optical system, a compound magnifying glass. The essence of the functioning of a microscope is that the test object is positioned between the single and double focus points of the objective, thus the light coming from the object and passing through the lens creates a magnified, inverted and real image of the subject on the other side of the objective, behind the double focus point. The eyepiece is at a distance from the objective lens so that the image formed by the objective is generated within the focus of the eyepiece. Thus, looking through the eyepieces, one can see a further enlarged, direct but virtual image of this real, inverted and magnified image. The magnification power of a bright-field microscope can be calculated by multiplying the magnification of the objective and of the eyepiece, respectively.

The objective lens system consists of multiple lenses. The first member is the front lens facing the object. This determines the magnification and resolution of the microscope. Other elements are responsible for the elimination of lens errors. The features of an image formed by the objective depend on the optical characteristics of the objective lens. The quality of a lens represents its property of how sharp the object image is drawn. The image imperfection, i.e. blurring is caused by lens errors (aberrations). Spherical aberration (spherical divergence) is caused when the lens away from the optical axis increasingly breaks the light rays passing through it, therefore a point-like object in the image will be blurred at the edge. The reason for chromatic aberration is that the focal points of different wavelengths of light do not coincide on the optical axis. Shorter wavelength rays unite closer, while longer wavelength rays unite farther. Thus, a sharp image cannot be obtained using white light, and the image has a coloured (rainbow) border. A concave flint glass lens with lead content and high refractive index is fitted to the convex lens to correct for chromatic aberration (the achromatic lens has two-colour correction, while the apochromatic lens has three-colour correction).

The resolution of the objective lens is the ability of how detailed the image of a subject can be drawn. The resolving power is quantified with the minimum distance between two points that are just distinguishable. The resolution (d) depends on the illumination wavelength of light used (λ), the half-angular aperture of the objective lens (α) and the refractive index of the material between the front lens and the cover slip (n).

$$d = 1.22 \lambda / 2 n \times \sin \alpha$$

where $n \times \sin \alpha$ = numerical aperture (NA).

The greater the resolution, the smaller the value of d is. This can be achieved by reducing the wavelength of light used, increasing the angular aperture of the objective, or increasing the refractive index of the material between the front lens and the cover slip. Using a light microscope, there is opportunity only to change the latter. For this purpose, cedar oil (oil immersion) is the most suitable material, because it has almost the same refractive index as that of the glass, so the light passes through a virtually homogeneous medium. The denominator of the above formula, $2 n \times \sin \alpha$ is the value of numerical aperture (NA), which may vary between 0.20 and 1.4 (always indicated on the lens).

The eyepiece draws a direct image of the test object. The fine structure of an image observed in the microscope depends on the details of the real picture, which in turn is determined by the resolution of the objective. This image, however, is not visible to the naked eye; it can only be visualised in the magnification of the eyepiece.

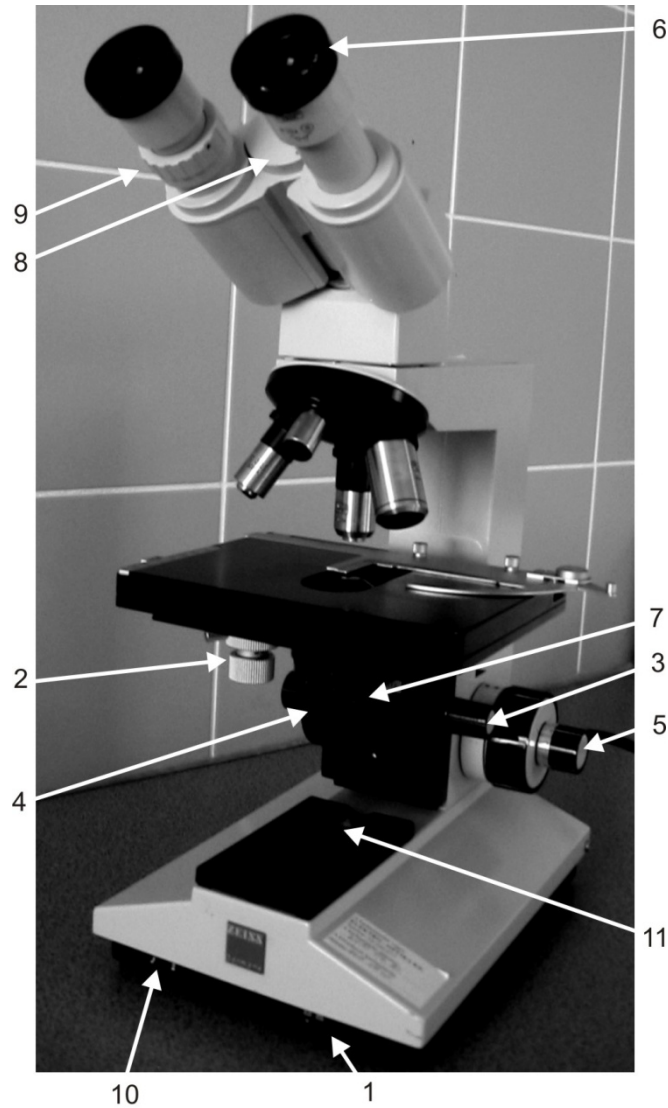

Fig. 9. Laboval 4 type microscope. (1) power switch, (2) stage x and y axis travel knobs, (3) condenser focus knob, (4) field lens, (5) coarse and fine focus knobs, (6) eyepiece, (7) condense aperture diaphragm control ring, (8) interpupillary distance scale of the binocular tube, (9) diopter ring, (10) brightness control dial, (11) gray filter.

EXERCISE 12: EXAMINATION OF MICROORGANISMS INHABITING NATURAL WATERS BY BRIGHT-FIELD LIGHT MICROSCOPY (WET MOUNT PREPARATION) (Fig. 10)

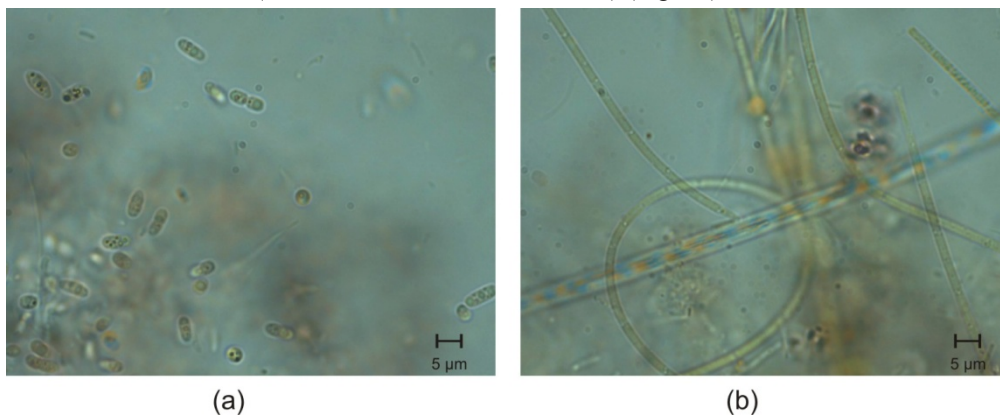

Fig. 10. Bright-field micrograph of microorganisms from natural waters. Rod and filamentous shape bacteria from an artificial pond.

Object of study, test organisms:

bacteria and protists of natural waters

Materials and equipment:

environmental water sample (e.g. from a lake, a stream, a creek or an aquarium)
glass slides
cover slips
glass dropper dispenser alcohol (for sterilisation)
Bunsen burner
light microscope

Practice:

1. Degrease the surface of a glass slide with alcohol over a Bunsen burner and then label the slide
2. Put one drop of the sample to the slide with a glass dropper.
3. Place the edge of a cover slip on the slide so that it touches the edge of the water drop. Slowly lower the cover slip to prevent the formation and trapping of air bubbles.
4. Place the sample under the microscope, and locate the focal plane.
5. Use first an objective lens of 16x, and then 40x magnification.
6. Observe the shape and movement of microbes, in case of protists and eukaryotic algae, try to identify the different cell organelles (e.g. chloroplasts, contractile vacuoles). Make drawings about the observations.

5.2. Fluorescence microscopy

Specimens that absorb light of one colour and subsequently emit light of another colour (fluoresce) can be visualised by using the fluorescence microscope. The basis of fluorescence microscopy is the principle of the removal of incident illumination by selective absorption, where light absorbed by the specimen and re-emitted at another wavelength is transmitted. The light source must produce light of appropriate wavelength and ineffective wavelengths that are unable to excite the fluorochrome used are removed by an excitation filter. A second, emission filter removes the incident wavelength from the beam of light fluoresced by the specimen. As a result, only light originating from specimen fluorescence constitutes the image.

The phenomenon when a sample (e.g. cell organelle of a microbe) shows fluorescence without prior staining is called auto-fluorescence. Otherwise, bacterial cells can be stained with a fluorescent dye. Using a fluorescent dye, e.g. DAPI (4',6-diamidino-2-phenylindole), cells are stained bright blue because the dye forms a complex with the cell's DNA. Fluorescent dyes are therefore widely applied to visualise and enumerate bacteria in different natural habitats or clinical samples.

Chapter 6. CELL- AND GERM-COUNTING METHODS

6.1. Determination of cell counts with microscope

To determine the number of suspended particles in a given volume (e.g. cells, spores of fungi), counting chambers are generally used (Fig. 11). These are microscopic slides into which cross-channels are grooved. The slide is thinner at these channels, so the height of the liquid column is known. As the size of the grid is also known, the volume between the slide and cover slip can also be precisely defined. These slides are usually thicker than the normal ones to avoid deformations. The overflowing liquid can freely exit.

The size and shape of grids can differ to fit the purpose of analysis. In the case of Thoma-chambers, the area of the big square is 1 mm^2 , which comprises 16 smaller squares. The area of the smaller squares is $1/16 \text{ mm}^2$ and with more divisions, the area of the smallest squares is $1/400 \text{ mm}^2$. The height of the more widely used Bürker-chambers is 0.1 mm (Fig. 11). The size of the big square is $1/5 \text{ mm} \times 1/5 \text{ mm} = 1/25 \text{ mm}^2$, and that of the rectangle is $1/5 \text{ mm} \times 1/20 \text{ mm} = 1/100 \text{ mm}^2$. There are several other counting chambers available with different rulings (e.g. Neubauer-, Türk-, Jensen-, Fuchs-Rosenthal). To get the correct count, it is important to repeat counting many times, possibly on several subsamples.

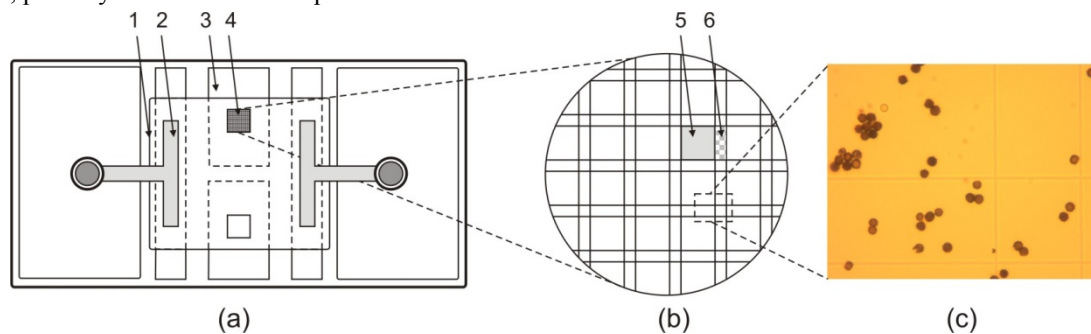

Fig. 11. Bürker-chamber. (a) Parts of the chamber 1. cover glass 2. clamp 3. counting chamber (drop the spore suspension here) 4. facet with grid (b) Enlarged grid 5. big square of $1/25 \text{ mm}^2$ area 6. rectangle of $1/100 \text{ mm}^2$ area. (c) Micrograph of spores from *Aspergillus niger* in a Bürker chamber.

EXERCISE 13: DETERMINATION OF *ASPERGILLUS NIGER* SPORE CONCENTRATION WITH BÜRKER-CHAMBER

Object of study, test organisms:

Aspergillus niger culture in Petri dish

Materials and equipment:

inoculating loop
sterile water in test tube
Bunsen burner
pipette, sterile pipette tips
Bürker-chamber
alcohol
light microscope

Practise:

1. Prepare a suspension from *Aspergillus niger* spores in sterile distilled water using an inoculating loop.

2. Degrease the Bürker-chamber with alcohol over a Bunsen burner.
3. Fix the cover slip to the chamber.
4. Put one drop of the spore suspension beside the cover slip of the chamber. The chamber will be filled with the suspension due to the capillary action.
5. Wait for 1-2 minutes until flow of the suspension stops.
6. Put the chamber under the microscope and adjust focus. Check your sample with 16x or 40x objective.
7. Count the number of spores in 10 big squares (or rectangles).
8. Average these values and then calculate the concentration of spores as spore count/mL for the suspension.

The cells to be enumerated can be stained for better observation. Classical staining procedures are reviewed in chapter 7.4.1. Additionally, fluorescent dyes are also widely used to determine cell counts in various environmental samples. One of such dyes is DAPI, which binds to the DNA of virtually every microorganism, but this stain is not suitable to assess cell viability since it fails to differentiate between living and dead cells.

EXERCISE 14: ENUMERATION OF MICROBES WITH DAPI STAINING

DAPI molecules are able to penetrate cell membranes and bind to the double helix of the DNA. Cells can be easily counted, if a known volume of fixed water sample is filtered through a membrane and, after staining the filter, surface is investigated by an epifluorescence microscope (Fig. 12).

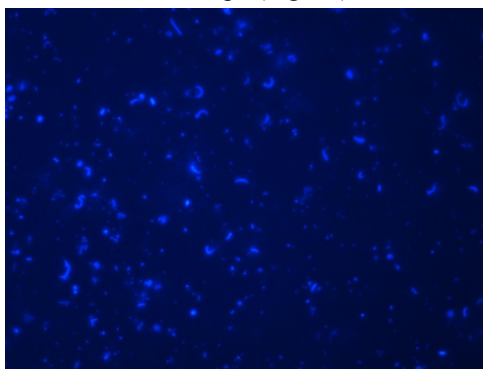

Fig. 12. Fluorescence microscopic image of DAPI stained bacterial cells. Bacterial cells from drinking water show blue fluorescence on the membrane filter.

Object of study, test organisms:

microbes of surface water samples

Materials and equipment:

disposable gloves
laboratory scales
paraformaldehyde (PFA)
beaker
magnetic stirrer
phosphate buffered saline (PBS) (see Appendix)
cc. NaOH solution
Pasteur pipette
membrane filtration apparatus
polycarbonate and cellulose nitrate membrane filters (0.22 or 0.45 μm pore size)
50 mL Falcon tube
plastic Petri dishes
scalpel

pipette with pipette tips
DAPI solution (1 µg/mL)
80% ethanol
double distilled water
glass slide
cover slip
Vectashield Mounting Medium (H-1000, Vector Laboratories Ltd)
immersion oil (non-fluorescent)
epifluorescence microscope with a mercury lamp
digital camera
computer with adequate softwares

Practise:

1. For the preparation of fixative solution, dissolve 1 g PFA in 50 mL PBS. (PFA causes irritation when inhaled, therefore the use of a fume hood is recommended.) Dissolution can be aided with heating (ca. 60°C), permanent stirring and adding some drops of cc. NaOH solution.
2. Adjust pH to 7.0.
3. Filter the solution through a 0.22 µm pore size membrane filter. (The prepared 2% PFA solution can be stored in the fridge for one week).
4. Filter the water sample (2-50 mL, depending on the type of sample) using polycarbonate membrane filter (slowly with occasional stirring). To help uniform cell distribution, place a 0.45 µm pore size cellulose nitrate membrane filter between the sieve of the filtration unit and the polycarbonate filter.
5. Fill the Falcon tube with fixative (PFA solution) and immerse the filter in it with sterile forceps (PFA solution must cover the entire membrane filter).
6. Incubate the filter overnight at 4°C.
7. Fill PBS into an empty Petri dish, then transfer the filter into the PBS solution for 1-2 minutes (liquid must cover the entire membrane filter).
8. Transfer the filter to another empty Petri dish and let it dry.
9. Cut a 0.5 by 0.5 cm piece from the filter with a scalpel or scissors, and pipette 30 µL DAPI solution onto its surface. From this step onwards, work in a dark place. The filter piece can be marked with a soft pencil.
10. After 2 minutes, transfer the filter into 80% ethanol for a few seconds.
11. Dip the filter paper into double distilled water for a few seconds.
12. Dry the filter.
13. Place the filter onto the surface of a glass slide, put a drop of Vectashield Mounting Medium onto the filter and then cover with a cover slip. Cover with paper towel and gently press the cover slip to remove any excess of mounting medium.
14. Examine the slide with epifluorescence microscope using a 100x objective and immersion oil under UV excitation (the absorption maximum of DAPI is at 358 nm, and emission maximum is at 461 nm).
15. Record images from at least 20 different microscopic fields with a digital camera.
16. Count the cells on each picture and determine the mean values.
17. Determine the cell count for one mL water sample based on the amount of filtered water and the size of the membrane filter field. Evaluate the variability of cell morphology.

(See also Supplementary Figure S21.)

6.2. PCR-based cell counts

Real-time PCR is a special PCR technique (see chapter 7.4.6), where the amount of products generated by the enzymatic multiplication of a given DNA region is continuously measured. It can be achieved by measuring the fluorescent signal emitted by the sample. There are different ways of signal generation, e.g. (1) binding fluorescent dye to the double stranded DNA product (2) using fluorescently labelled sequence-specific probes. The copy number of the original DNA can be estimated on the basis of the increasing signal in the early exponential phase of the reaction. With the application of adequate reference standards, the copy number of a given gene/region can be evaluated in the original sample. When the copy number of the PCR amplified region(s) is known for the given bacterium strain/cells, then its cell count can be also estimated (Fig. 13).

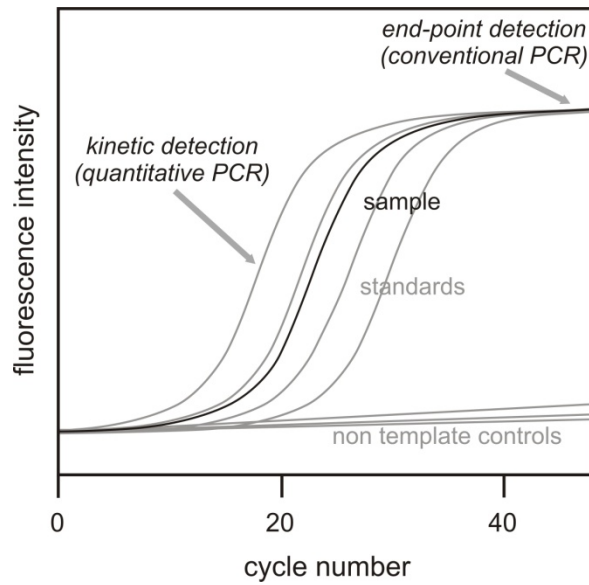

Fig. 13. Real-time PCR-based bacterial cell counting. Kinetic detection or the product quantity at realtime PCR gives a similar curve to bacterial growth. Fluorescence intensity is a function of template copy number in case PCR parameters are identical.

6.3. Determination of germ counts based on cultivation

Cultivation techniques enable the evaluation of the number of microbes in a given sample which are able to grow on a given medium. As a “universal medium” does not exist (on which all microbes are able to grow), only a small portion of microbes can be cultivated from a given environment. Therefore, quantitative techniques based on cultivation are mainly used for estimation and comparison of the number of microbes of a specific physiological group from different habitats. The most frequently used techniques are the CFU counting methods (spread-plate and pour-plate techniques, and the membrane filter technique) and the end point dilution method (MPN= Most Probably Number).

6.3.1. CFU-counting techniques

With the classical dilution-spreading techniques, only 0.1-1% of microbes in a sample can be cultivated. There are many reasons to it: there is not any medium on which all microbes can be cultivated from a given sample, moreover cells can be in a ‘VBNC’ (Viable But Non Cultivable) state. Though counting methods based on cultivation can give important information about the number of microbes in a sample, usually they underestimate the real numbers. The counting techniques are based on the assumption that a single colony develops from each cell and that all colonies are formed from a single mother cell. However, sometimes microbes clump and a single colony may grow from several microbes clustered together. The viable count is thus invariably less than the total cell number in a sample.

From most samples (e.g. soils), a suspension must be prepared first and diluted. Usually a 10-fold dilution series is applied. Different media can be used for a given sample. A known volume (0.1 mL) of the dilutions is plated onto the surface of a suitable growth medium (Fig. 14). After the infected plates had been incubated up to one week, the average number of colonies on plates can be determined. Plates harbouring between 20-200 colonies are optimum for counting. The number of viable microbes per millilitre (or g) of the initial sample (culture) can be calculated from the average of colony numbers on parallel plates and the known dilution factor (CFU/mL or g sample).

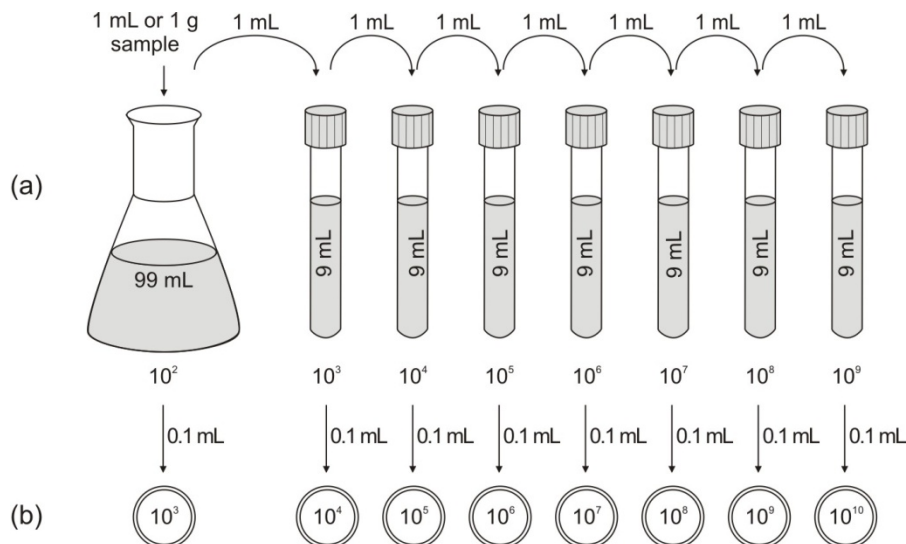

Fig. 14. Germ count estimation using the spread plate technique. (a) The sample is diluted in sterile distilled water, and a 10-fold dilution series is prepared. (b) Appropriate amounts of these dilutions are plated onto suitable growth medium in the Petri plate.

EXERCISE 15: QUANTIFYING HETEROTROPHIC MICROBES USING THE SPREAD-PLATE TECHNIQUE

The diluted sample is pipetted onto the surface of a solidified agar medium and spread with a sterilised, bent glass rod (glass spreader) for the determination of heterotrophic plate count using the spread-plate method.

Object of study, test organisms:

environmental sample (e.g. soil or water)

Materials and equipment:

agar plates
 glass spreader (alcohol for sterilisation)
 pipettes, sterile pipette tips
 99 mL sterile distilled water in a flask
 9 mL sterile distilled water in test tubes
 vortex mixer
 Bunsen burner
 incubator

Practise:

1. Make a 10-fold dilution series from an environmental sample: measure 1 g soil sample into a flask containing 99 mL sterile water (or 1 mL water sample to 99 mL sterile water) mix thoroughly with vortex mixer, pipette 1 mL from this suspension into a test tube containing 9 mL sterile water, mix thoroughly with vortex, pipette 1 mL from this latter suspension into another test tube containing 9 mL sterile water, mix thoroughly, etc. (until the desired degree of dilution is reached) (Fig 14.). Use unambiguous labelling throughout the practise (indicate sample name, degree of dilution, etc.).

- Spread 0.1 mL from the given dilution onto the surface of agar plates: pipette 0.1 mL from the appropriate member of the dilution series onto the centre of the agar surface; rinse the glass spreader with alcohol (remove any excess alcohol) and sterilise the rod by flaming (take the rod away from the flame while the alcohol burns); cool down the glass spreader by touching the medium surface (without touching the liquid containing bacteria); spread the liquid evenly over the surface (while spreading dish should be opened only slit like) (Fig. 15).
- Incubate Petri dishes at 28°C for one week.
- Count the number of discrete colonies, in case of parallel plates, average the numbers and calculate the CFU value of the sample. Results of different dilutions should also be averaged. Give the CFU values of the original sample in CFU/mL or CFU/g units.

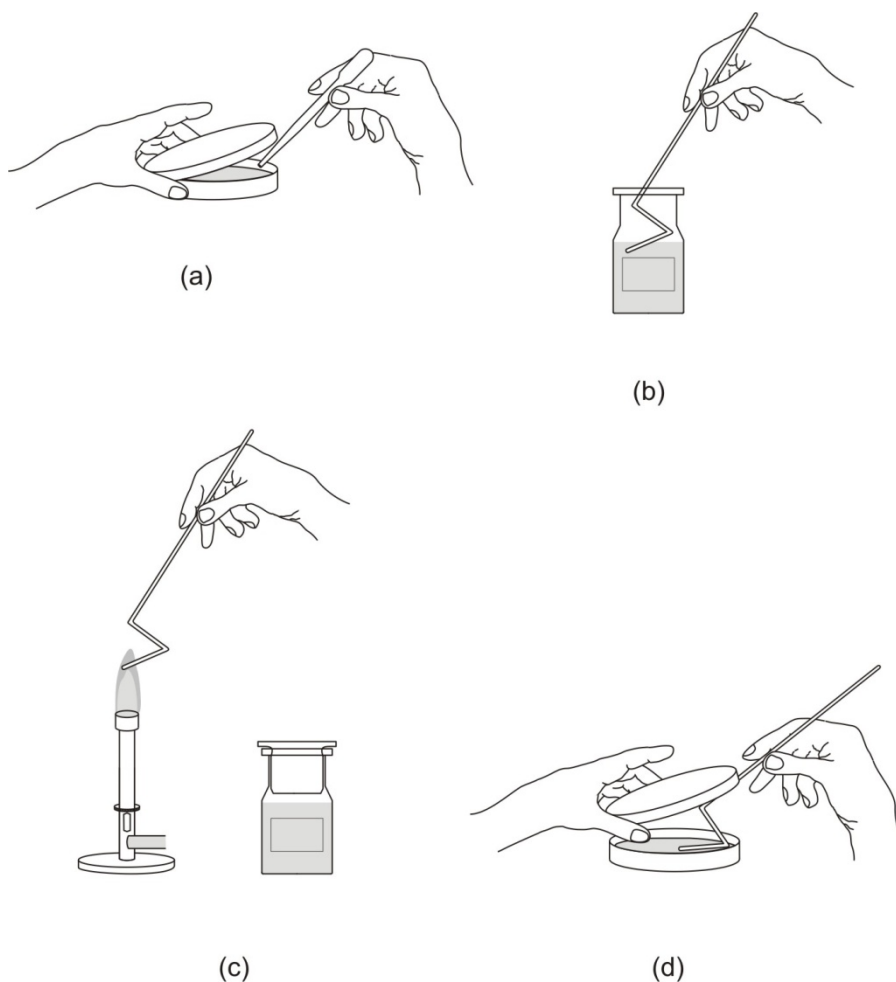

Fig. 15. Spreading on the surface of an agar plate. (a) Pipette 0.1 mL from the appropriate member of the dilution series onto the centre of the surface of an agar plate. (b) Dip the L-shaped glass spreader into alcohol. (c) Flame the alcohol on the surface of the glass spreader over a Bunsen burner. (d) Spread the sample evenly over the surface of agar using the sterile glass spreader, carefully rotating the Petridish underneath at the same time.

EXERCISE 16: QUANTIFYING HETEROTROPHIC BACTERIA USING THE POUR-PLATE TECHNIQUE

In the pour-plate method, a sample from an accurate dilution of microbes/sample is pipetted into a Petri-dish, and then agar medium is poured over the liquid and mixed or the adequate volume of sample is mixed with the melted agar medium and poured into Petri dishes.

Object of study, test organisms:

environmental sample (eg. soil or water)

Materials and equipment:

sterile, empty Petri dishes
 pipette, sterile pipette tips
 99 mL sterile distilled water in a flask
 9 mL sterile distilled water in test tubes
 melted growth medium in test tubes
 Bunsen burner
 incubator

Practise:

1. Make a dilution series from an environmental sample (10 fold, see EXERCISE 15).
2. Pipette 0.1-0.1 mL sample into the labelled Petri dishes from each dilution.
3. Pour 20-25 mL sterile, melted (ca. 50°C) medium into the inoculated Petri dishes and mix them softly. Let it solidify.
4. Incubate Petri dishes at 28°C for one week.
5. Count the number of discrete colonies, in case of parallel plates, average the numbers and calculate the CFU value of the sample. Results of different dilutions should also be averaged. Give the CFU values of the original sample in CFU/mL or CFU/g units.

6.3.2. The membrane filter technique

The membrane filter technique is used to estimate the plate counts from low germ count samples. In this technique, a known volume of sample is filtered through a membrane filter and bacterial cells are retained on its surface. Then the filter is placed onto a Petri plate (Fig. 16). The nutrients diffuse through the filter from the medium and allow the development of colonies. After the adequate incubation period, colony count on the surface of the filter can be determined.

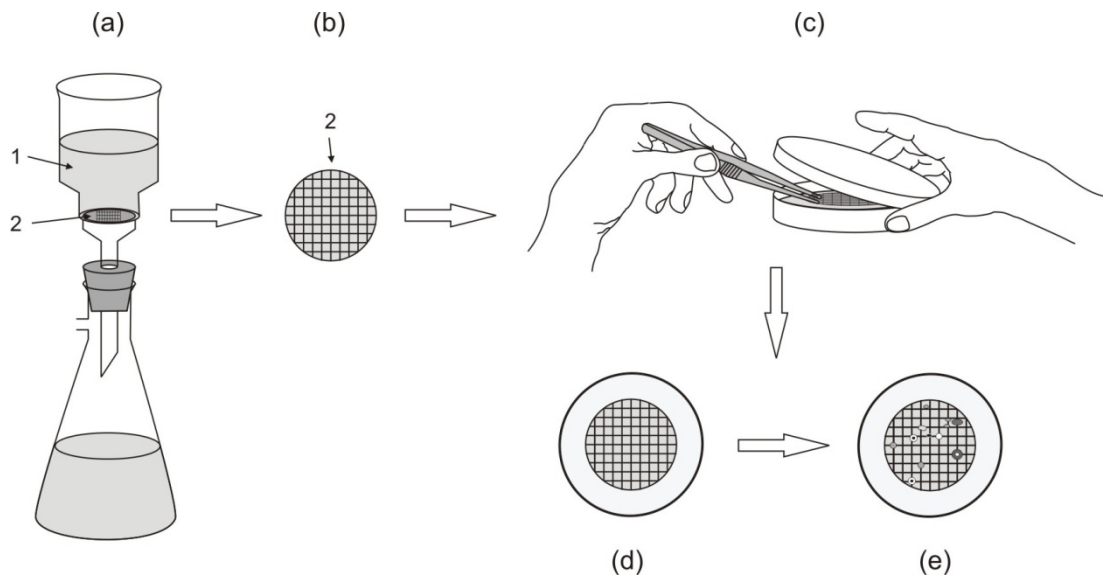

Fig. 16. Germ count estimation using the membrane filter technique. (a) Known quantity of sample (1) is filtered through a membrane filter (2). (b-c) The filter is placed onto a Petri plate using sterile forceps. (d-e) After the adequate incubation period, CFU values on the surface of the filter can be counted.

EXERCISE 17: QUANTIFYING HETEROTROPHIC BACTERIA USING THE MEMBRANE FILTER TECHNIQUE

Object of study, test organisms:

water sample

Materials and equipment:

nutrient agar plates (see Appendix)
 0.45 μm pore size membrane filter
 sterile measuring cylinder
 filtration equipment
 incubator

Practise:

1. Filter 100/200 mL water sample using a 0.45 μm pore size membrane filter.
2. Place the filter onto the surface of an adequate medium in Petri plate (nutrient medium).
3. Incubate the Petri dish at 28/37°C for one week.
4. Determine the germ count in 1 mL water sample considering the amount of filtered water.

(See also Supplementary Figure S25.)

6.3.3. The end point dilution technique (MPN method)

The end point dilution method (MPN=Most Probable Number) is based on a series of dilutions prepared from a sample, where selected liquid media are inoculated with each dilution using 3-5 parallels (Fig. 17). After the incubation period, estimation of microbial germ count is possible using statistical tables based on the number of positive tubes/wells (showing characteristic microbial growth: change in optical density, shifting of pH, changing of redox values and subsequently colour, etc.). This method presumes that in the liquid medium the distribution of cells is uniform, cells do not cluster together and that there is detectable growth even if only one viable microbial cell is present in the tube/well.

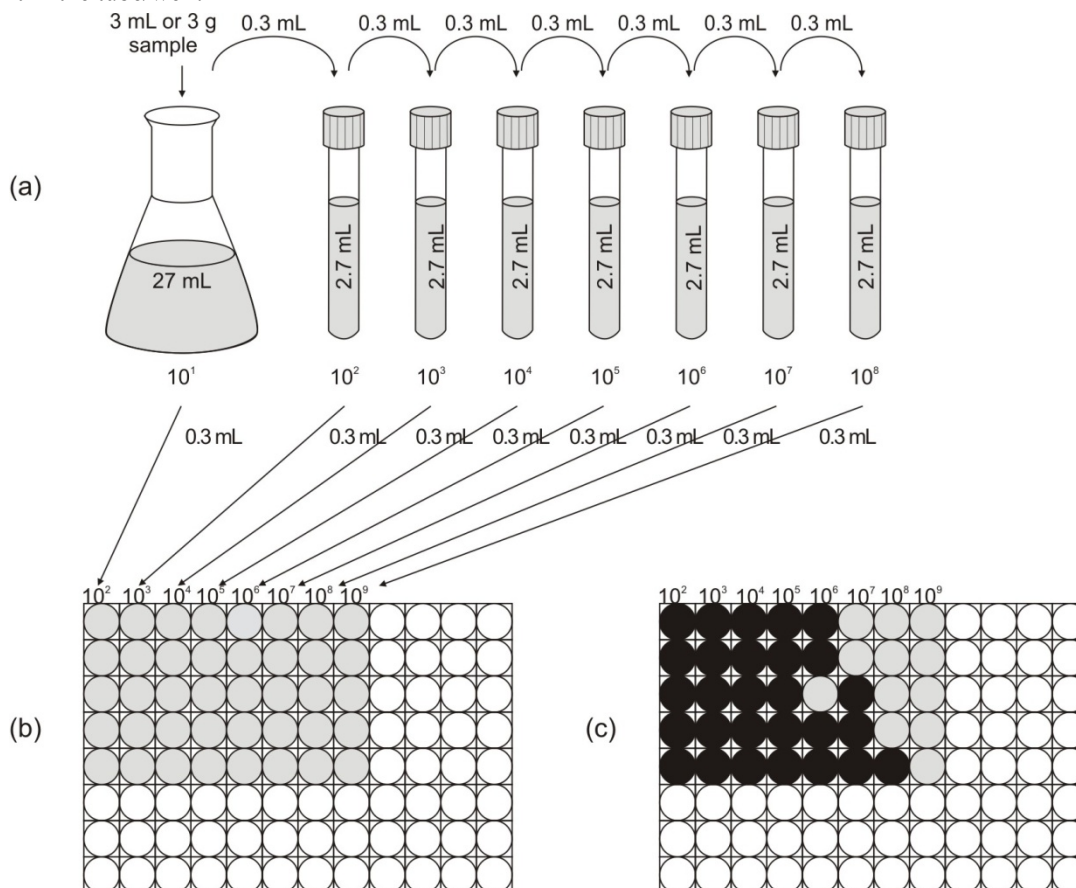

Fig. 17. Germ count estimation with MPN method. (a) The sample is diluted in the selected liquid medium, and a 10-fold dilution series is prepared. (b) Appropriate amounts of these dilutions are measured into the wells of a microplate using 5 parallels. (c) Results can be read after incubation period. Black colour change indicates a positive test result. Germ counts can be determined by using the adequate McCarty statistical table (see Appendix).

EXERCISE 18: DETERMINATION OF THE NUMBER OF MESOPHILIC ANAEROBIC SPORE-FORMING (SULPHITE REDUCING) BACTERIA WITH MPN METHOD

Object of study, test organisms:

Clostridium sp. suspension (duplicate copies)
soil sample

Materials and equipment:

DRCM differential medium (see Appendix)
pipette, sterile pipette tips
water bath
test tubes with sterile 9 mL distilled water
paraffin oil
incubator

Practise:

1. Prepare a soil suspension from 1 g soil in 9 mL sterile distilled water in duplicate and also from the *Clostridium* cultures.
2. Put one bacterial suspension and one soil suspension into 80°C water bath for 5 min to inactivate the vegetative forms of bacteria.
3. Make a 10-fold dilution series both from the heat-treated, and from the untreated samples (see EXERCISE 15).
4. Make 3-3 parallel subcultivations from all dilutions in DRCM-containing test tubes.
5. Cover the inoculated test tubes with 2-3 mm paraffin oil to assure anaerobic conditions.
6. Incubate the prepared tubes at 30°C for 44-48 hours.
7. Evaluate the germ counts of the original sample from the number of positive test tubes using the McCarty statistical table (see Appendix). Compare the different samples and treatments.

Chapter 7. STRAIN CULTURE AND CULTIVATION-BASED TECHNIQUES

7.1. Demonstration of microbes in the environment

Mankind has been using microbial activities from the earliest times, without knowledge on microbes. Production of alcoholic beverages, lactic acid fermentation-based food or fodder are ancient. Even separation to linen- or hemp-based spinning exploits microbial enzyme activities. These can be demonstrated under laboratory conditions today when most of the acting agents are known.

Sauerkraut is a product of fermentation. The sauerkraut fermentation process utilises the indigenous bacterial population of raw cabbage to produce lactic acid. Fermentation generates a low pH environment, which allows few (if any) other bacteria to survive. Lactic acid also gives sauerkraut a characteristic sour flavour. Salt is added to raw cabbage to draw out much of the water and to inhibit salt-intolerant bacteria. This allows acid-producing bacteria to get a strong foothold and dominate the population.

The typical routine is to mix the cabbage with salt and then let it stand in a vat or barrel for the 6-8-week fermentation period. Then the sauerkraut is ready to eat.

The following processes will take place during sauerkraut fermentation:

Mixed acid fermentation: by the members of the family Enterobacteriaceae

Heterolactic fermentation: *Leuconostoc mesenteroides*

Homolactic fermentation: *Lactobacillus brevis*, *Lactobacillus plantarum*

EXERCISE 19: PREPARING SAUERKRAUT IN THE LABORATORY

Object of study, test organisms:

fermentative bacteria of sauerkraut

Materials and equipment:

2 kg (shredded) cabbage
plastic jar
devices to depress cabbage (e.g. pebble, wooden spatula)
50 g salt (3 tablespoons)
spices

Practise:

1. Shred the cabbage finely, put it into a large clean dish.
2. Mix cabbage with salt and other spices (pepper, bayleaf, etc.) with your hands (wash your hands before mixing).
3. *Pack a plastic jar tight, nearly full with the cabbage, press down e.g. with a clean pebble and close the bucket. During the fermentation process, cabbage needs daily attention.*
4. *Remove scum if formed and wash and scald pebble to keep it free from scum and mould. At room temperature, fermentation will be completed in 10 to 12 days. Incubation could be performed also at lower temperature (8-10°C), however it takes several weeks. If there is not enough juice (juice should cover the cabbage), supplement with thin brine by dissolving 30 g salt in 1 L water.*

5. Control the pH of the sauerkraut weekly. When the pH is around 3.5-4.0, perform Gram staining from the juice of the sauerkraut (see EXERCISE 37). Taste the sauerkraut.

Pectins are complexes of large polysaccharide molecules, made up (mainly) of chains of several hundred galacturonic acid residues. Pectinase is a general term for enzymes that break down the polysaccharide pectin and *are actually a mixture of several enzymes: often* acting in different ways on the pectins. Pectin is the jelly-like cell wall matrix that helps cement plant cells together and in which other cell wall components, such as cellulose fibers, are embedded. Pectinases are produced during the natural ripening process of some fruits, where, together with cellulases, they help to soften the cell walls. Therefore pectinase enzymes are commonly used in processes involving the degradation of plant materials, even in the industry. One of the most studied and widely used commercial pectinases is polygalacturonase. Pectinases are also secreted by plant pathogens, such as the fungus *Monilinia fructigena* and the soft-rot bacterium *Erwinia carotovora*, as part of their strategy for penetrating the plant host cell walls. In fact, the products of such enzyme assaults (oligosaccharins) act as a signal that induces uninfected cells to defend themselves.

Among root-vegetables, the *Erwinia* species cause significant harm during the cultivation and storage of the plant. *Erwinia carotovora* (phytopathogen bacterium) is a Gram-negative, rod shaped bacterium, the primary agent e.g. of soft rot.

EXERCISE 20: DEMONSTRATION OF MICROBES DIGESTING PECTIN - ACTION OF PECTINASES DURING ANAEROBIC DIGESTION - "HEMP-RETTING"

Object of study, test organisms:

pectin digesting bacteria from the soil (e.g. *Clostridium* spp.)

Materials and equipment:

hemp
cotton yarn
test tube with distilled water
soil sample
water bath
microscope

Practise:

1. Make a bunch of hemp (or straw) with cotton yarn.
2. Fill a test tube with water, put one spoon of soil and subsequently the hemp into the tube.
3. Boil it for 3-5 minutes (to force the water into plant fibres and to kill most non-spore-forming bacteria).
4. As a control, use a test tube where soil is added only after the boiling process.
5. After one week of incubation at 28°C, spore staining (see EXERCISE 40) is suggested from the supernatant to see anaerobic spore-forming bacteria.
6. Check your slides with a microscope.

EXERCISE 21: DEMONSTRATION OF MICROBES DIGESTING PECTIN – SOFT-ROT TEST

Object of study, test organisms:

Erwinia carotovora

Materials and equipment:

potato
carrot
scalpel

Erwinia carotovora suspension
pipette, sterile pipette tips
sterile glass Petri dish with wet cotton swab
incubator
microscope

Practise:

1. After washing, cut slices of potato and carrot with a sterilised scalpel and put them into a sterile glass Petri dish (two slices of each).
2. Add 100 μ L suspension of *Erwinia carotovora* onto one of the slices. As control, pipette the same amount of distilled water onto the other slice.
3. Incubate for a week at 28°C.
4. Evaluate result with direct observation and with Gram staining (see EXERCISE 37).

7.2. Preparation of microbiological culture media

The survival and growth of microorganisms depend on available and a favourable growth environment. Culture media are nutrient solutions used in laboratories to grow microorganisms. For the successful cultivation of a given microorganism, it is necessary to understand its nutritional requirements and then supply the essential nutrients in the proper form and proportion in a culture medium. The general composition of a medium is as follows:

H-donors and acceptors (approximately 1-15 g/L)
C-source (approximately 1-20 g/L)
N-source (approximately 0.2-2 g/L)
Other inorganic nutrients e.g. S, P (50 mg/L)
Trace elements (0.1-1 μ g/L)
Growth factors (amino acids, purines, pyrimidines, occasionally 50 mg/L, vitamins occasionally 0.1-1 mg/L)
Solidifying agent (e.g. agar 10-20 g/L)
Solvent (usually distilled water)
Buffer chemicals

Microbiological culture media could be classified according to:

1. **Consistency**, which could be adjusted by changing the concentration of solidifying or gelling agents, e.g. agar, gelatine (liquid media do not contain such materials)
 - Cultures in liquid media (or broth) are usually handled in tubes or flasks and incubated under static or shaken conditions. This way, homogenous conditions are generated for growth and metabolism studies, (e.g. with the control of optical density and allowing sampling for the analysis of metabolic products).
 - Semisolid media are usually used in fermentation and cell mobility studies, and are also suitable for promoting anaerobic growth.
 - Solid media are prepared in test tubes or in Petri dishes, in the latter case, the solid medium is called agar plate. In the case of tubes, medium is solidified in a slanted position, which is called agar slant, or in an upright position, which is called agar deep tube. Solid media are used to determine colony morphology, isolate cultures, enumerate and isolate bacteria (e.g. using dilutions from a mixed bacterial population in combination with spreading), and for the detection of specific biochemical reactions (e.g. metabolic activities connected with diffusing extracellular enzymes that act with insoluble substrates of the agar medium).
2. **Composition**
 - Chemically-defined (or synthetic) media are composed only of pure chemicals with defined quantity and quality.

- Complex (or non-synthetic) media are composed of complex materials, e.g. yeast extract, beef extract and peptone (partially digested protein), therefore their chemical composition is poorly defined. On the other hand, these materials are rich in nutrients and vitamins.

3. Function

- All-purpose media do not contain any special additives and they aim to support the growth of most bacteria.
- Selective media enhance the growth of certain organisms while inhibit others due to the inclusion of particular substrate(s).
- Differential media allow identification of microorganisms usually through their unique (and visible) physiological reactions. In the detection of common pathogens, most practical media are both selective and differential.
- Enrichment media contain specific growth factors that allow the growth of metabolically fastidious microorganisms. An enrichment culture is obtained with selected media and incubation conditions to isolate the microorganisms of interest.

EXERCISE 22: PREPARATION OF AGAR SLANTS

Object of study:

preparation of agar slants

Materials and equipment:

distilled water
measuring cylinder
flask
bacteriological chemicals
laboratory scales
chemical spoons
1N NaOH solution
1N HCl solution
pH indicator paper or pH meter
cotton gloves
dispenser
test tubes
test tube caps
test tube basket
slanting stage
autoclave
incubator

Practise:

1. Measure the components of the medium (e.g. TSA or nutrient, see Appendix) into a flask containing 9/10 volume of the solvent. Use a clean chemical spoon for every measurement. Dissolve the solid components and fill with the remaining solvent up to final volume. If the medium contains heat sensitive components (like sugars), they must be separately sterilised in solution (e.g. by filter sterilisation), and then mixed with the already sterilised and cooled agar medium.
2. Close the flask with cotton plug and cover with aluminium foil, put into the autoclave and start a sterilisation cycle (see EXERCISE 1). This cycle could be intermitted when the internal temperature has reached 121°C, at that temperature every component (e.g. agar-agar) will be dissolved correctly.
3. Check the pH of the medium with an indicator paper or with a pH meter and adjust to the proper value with NaOH or HCl solution.
4. Pour the 60-70°C medium into the dispenser. Add 5-6 mL medium to each test tube, close them with caps and place them into a test tube basket.

5. Place the tubes into the autoclave and complete a whole sterilisation cycle for 20 min at 121°C (see EXERCISE 1).
6. Put the test tubes onto a slanting stage to let the medium solidify in the test tubes.
7. Label the slants according to the type of the medium and perform a sterility test: incubate the test tubes at 28°C for 24 hours, and check for sterility.
8. The prepared media can be stored for 1-2 weeks at 12-15°C, or longer in a refrigerator. (Do not store medium containing agar-agar under 4-5°C as it destroys its structure!)

EXERCISE 23: PREPARATION OF AGAR PLATES

Object of study:

preparation of agar plates

Materials and equipment:

distilled water
measuring cylinder
flask
bacteriological chemicals
laboratory scales
chemical spoons
1N NaOH solution
1N HCl solution
pH indicator paper or pH meter
cotton gloves
sterile, empty Petri dishes
Bunsen burner
autoclave
incubator

Practise:

1. Prepare a medium as in EXERCISE 22.
2. Cool the sterilised medium to 55°C.
3. Take out the cotton plug and flame the mouth of the flask over a Bunsen burner, and then pour the medium into sterile, empty Petri dishes (15-20 mL into each Petri dish).
4. Keep the Petri dishes horizontally until the medium completely solidifies. Turn dishes upside-down and stack them up for storage.
5. Label the plates according to the type of the medium and perform a sterility test as in EXERCISE 22
6. In case of longer storage, Petri plates must be placed into plastic bags or boxes to avoid drying out.

EXERCISE 24: PREPARATION OF AGAR PLATES WITH AUTOMATIC EQUIPMENT

Automatic and semi-automatic equipment, like surface spreading or medium dispenser equipment make laboratory work quicker. Inside the equipment used during the practical course, Petri dishes are moved and opened automatically and a peristaltic pump fills the medium. The dispenser pipe is opened only for the period the medium is portioned in order to avoid any drops between the Petri plates. There is also a UV lamp inside the equipment to avoid contamination (Fig. 18).

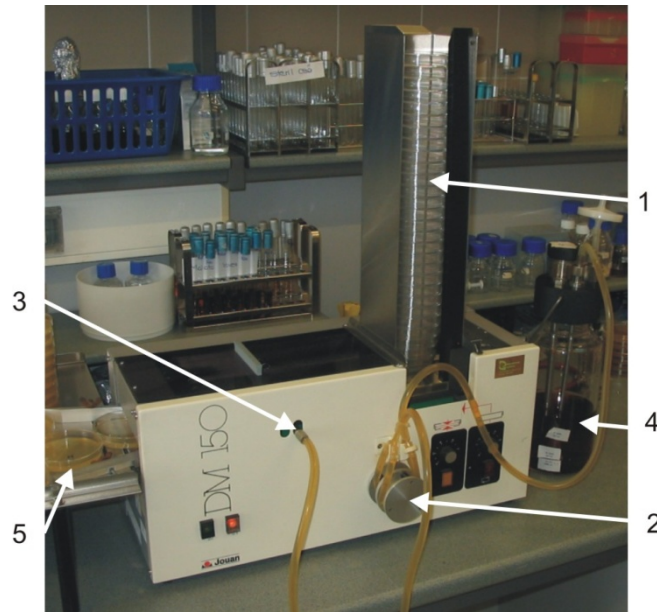

Fig. 18. Semi-automatic equipment for the preparation of agar plates (Plate pourer). Stacked closed Petri dishes (1) fall opened on a conveyor belt inside the equipment, where they move together with the lid automatically to a dispenser pipe. A peristaltic pump (2) through the dispenser pipe (3) fills a preset volume of the medium (4) into the Petri dish. The conveyor belt moves further the Petri dish, the cover falls atop the filled bottom, and finally the ready to use plates (5) come out from the equipment.

Object of study:

preparation of agar plates

Materials and equipment:

distilled water
 measuring cylinder
 flask
 bacteriological chemicals
 laboratory scales
 chemical spoons
 1N NaOH solution
 1N HCl solution
 pH indicator paper or pH meter
 cotton gloves
 sterile, empty Petri dishes
 automatic equipment for medium preparation
 autoclave
 incubator

Practise:

1. Prepare a medium as in EXERCISE 22 using the special flask of the plate-pourer apparatus.
2. Cool the sterilised medium to 55°C.
3. Fix one end of the sterilised silicone pipe to the top of the flask and the filler end to the automatic dispenser equipment. Stack empty, sterile Petri dishes to the dish container.
4. Switch on the UV lamp, adjust the thickness of the plate and start dispensing.
5. Keep the Petri dishes on the cooling platform until the medium completely solidifies.

6. Label the plates and perform a sterility test as in EXERCISE 22

7.3. Basic bacterial cultivation techniques

7.3.1. Enrichment

Enrichment media promote the growth of a particular microorganism against the others present in the sample by its specific nutrient utilisation ability or other unique metabolic properties (e.g. resistance to antibiotics or heavy metals). Only those microbes can grow in the enrichment medium that can use or tolerate the components of the selective medium.

EXERCISE 25: PREPARATION OF ENRICHMENT CULTURES

Object of study:

gasoline degrading bacteria
cellulose degrading bacteria
Mercury-resistant bacteria

Materials and equipment:

garden soil
gasoline-containing enrichment broth (see Appendix)
cellulose-containing enrichment broth (see Appendix)
HgCl₂-containing enrichment broth (see Appendix)
sterile chemical spoons
laboratory scales
shaker incubator
glass spreader (alcohol for sterilisation)
Bunsen burner
incubator

Practice:

1. Measure 1-1 g of the garden soil into the flasks containing different enrichment broths.
2. For better aeration, place the inoculated flasks into a shaker incubator at 28°C for one week.
3. Prepare a five-member, 10-fold dilution series (see EXERCISE 15) from the enrichment cultures and the original sample.
4. Spread the surface of agar plates (see EXERCISE 15) having the same composition as the enrichment broths from the individual members of the dilution series.
5. Incubate the cultures at 28°C for one week.
6. Perform germ count estimations (see EXERCISE 15) and colony morphology examinations (see EXERCISE 35) after the incubation period.

EXERCISE 26: PREPARATION OF WINOGRADSKY COLUMN FOR THE ENRICHMENT OF PHOTOTROPHIC BACTERIA

The Winogradsky column (Fig. 19) is a small ecological system (microcosm), which models the microbial processes taking place primarily in freshwater lake benthic environments. Due to the natural selection processes occurring in the column in a few weeks, bacterial communities with diverse species composition develop at various depths, mainly according to the different oxygen sensitivity of the photosynthetic bacteria. In a Winogradsky column, presence and enrichment of purple and green anoxygenic phototrophic bacteria (e.g. *Chromatium* and *Chlorobium*), sulfate-reducing bacteria (e.g. *Desulfovibrio*), and many other anaerobic microorganisms can be observed with the naked eye and by microscopy as well.

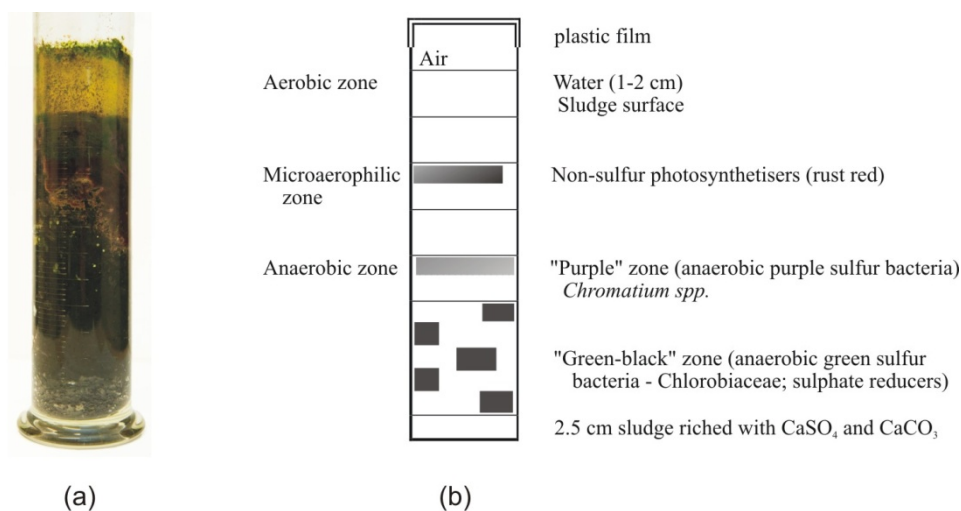

Fig. 19 The Winogradsky column. (a) Picture of a three-month-old column. (b) Schematic representation of the column structure.

Object of study:

anoxygenic phototrophic bacteria
sulfate-reducing bacteria

Materials and equipment:

garden soil or lake mud
 CaCO_3
 CaSO_4
laboratory scales
chemical spoons
bowl
filter paper
measuring cylinder
plastic film (Parafilm)

Practice:

1. Mix 100 to 200 g of sieved garden soil with 3-5 g calcium carbonate and 3-5 g calcium sulphate in a bowl. Tear filter paper into small pieces and mix them with the soil. Then add tap water to the soil mixture until it reaches a cream-like consistency.
2. Apply the enriched soil to the bottom of a measuring cylinder in a thickness of about 2-5 cm; subsequently fill the column uniformly with lake mud at a height of about 15-25 cm. The column is appropriate if it has no air bubbles, and after standing for 24 hours about 0.5 cm layer of water covers the mud (pour off the excess). To avoid dehydration, close the top of the measuring cylinder with plastic film.
3. Place the column near the window for at least 4-6 weeks at room temperature (avoid direct sunlight and over-heating).
4. During the incubation period, follow-up the enrichment of anoxygenic phototrophic and sulphate reducing bacteria by colour changes observed in the column. After the incubation period, carefully dissect the column and carry out microscopic examinations on anoxygenic phototrophic and sulphate reducing bacteria.

7.3.2. Spread plate and pour plate methods

The description of these methods is given in Chapter 6.3.1.

7.3.3. Isolation and streak plate technique

During isolation, bacterial cells from a discrete colony that developed on the surface of an agar plate are transferred to an agar slant having the same composition. The culture developing on the surface of the agar slant after the isolation is called an isolate.

To aseptically transfer microorganisms from broth, slant or agar cultures to another medium, inoculating needles or loops are used. They are made up of a handle, a shaft, a turret and a straight or a loop-ended nickel-chromium needle (Fig. 20).

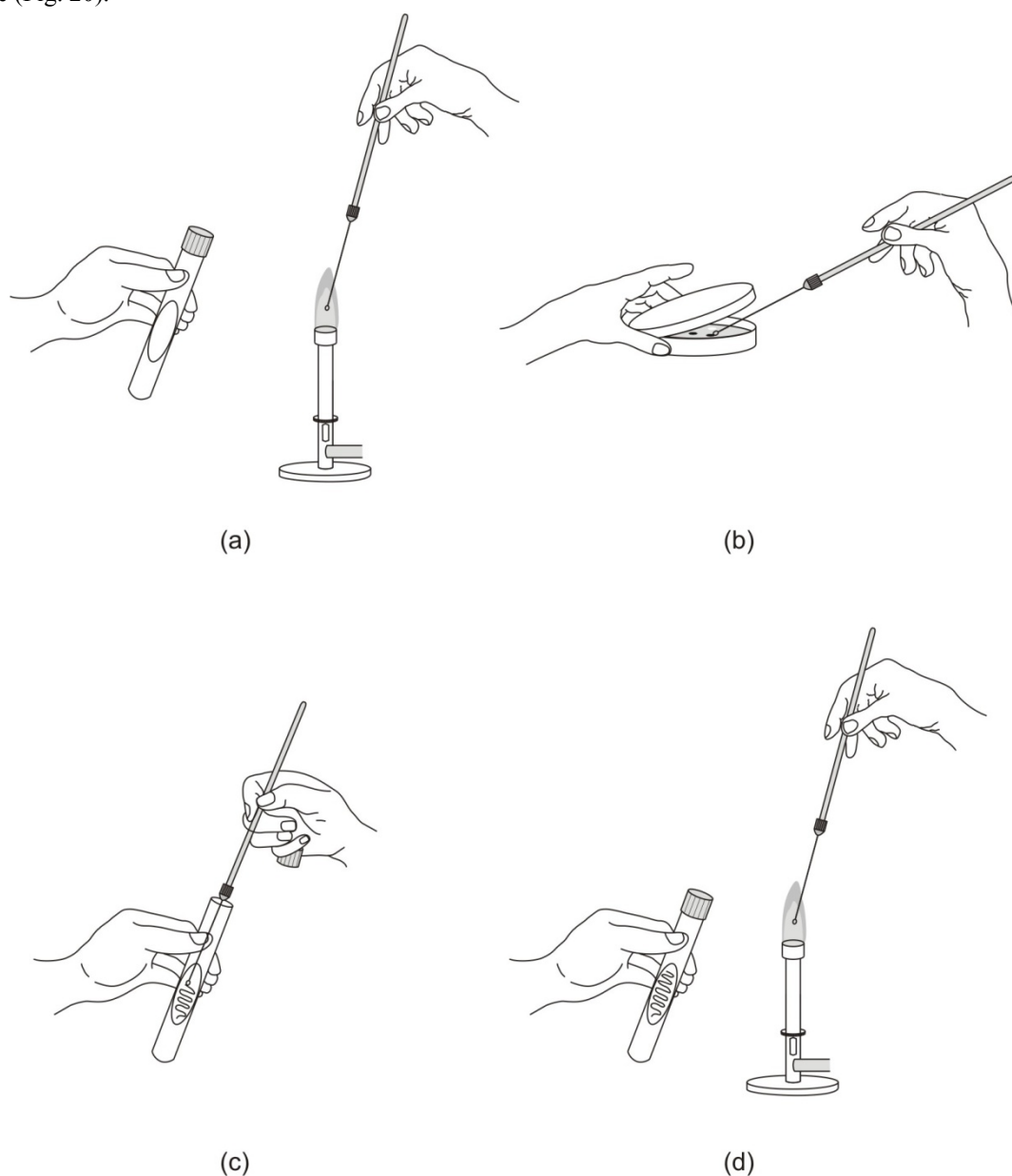

Fig. 20. Isolation. (a) Take the inoculating loop in one hand and hold it like a pencil. Flame the inoculating loop over a Bunsen burner until the wire becomes red-hot. (b) Make a gap on the Petri dish and choose a discrete colony to pick up a loopful of inoculum with the inoculating loop, then close the lid of the Petri dish. (c) After opening

and flaming the neck of the test tube, inoculate the surface of the agar slant in zigzag streaks using the infected inoculating loop. (d) Re flame the neck of the tube, close it and sterilise the loop with re flaming as well.

EXERCISE 27: ISOLATION OF CULTURES FROM THE AGAR SURFACE

Object of study:

bacteria present in soil samples
bacteria present in water samples

Materials and equipment:

agar plates inoculated by spread plate technique
agar slants
inoculating loop
Bunsen burner
incubator

Practice:

1. Label slant to be inoculated with the date, your name and name/code/ number of isolate. Select adequate colonies from the plate culture by marking them on the bottom of the Petri dish.
2. Take the inoculating loop and hold it like a pencil. Flame the inoculating loop over a Bunsen burner until the wire becomes red-hot.
3. Open the lid of the Petri dish culture to a gap and cool the hot loop by inserting it into the agar without touching any colonies developed on the surface. Choose a discrete colony and pick a loopful of inoculum using the inoculating loop, and then close the lid of the Petri dish.
4. Using the same hand that is holding the inoculating loop, remove the cap from a test tube, hold it between your fingers, and briefly flame the neck of the tube over a Bunsen burner by passing through the flame.
5. Inoculate the surface of the agar slant in zigzag streaks using the infected inoculating loop.
6. Flame the neck of the tube again and close it with the cap.
7. Sterilise the loop again by flaming over a Bunsen burner until the wire becomes red-hot. Take care to place the infected loop first into the core of the flame, and then slowly pull it upwards until it becomes red-hot.
8. Place the tube and the inoculating loop on the rack.
9. Incubate the slant at 28°C for one week.
10. Check the growth of the isolate after the incubation period.

(See also Supplementary Figure S15.)

An isolate is not necessarily a pure culture, i.e. containing cells of the same origin (derived from a single mother cell/a clone of cells). In mixed cultures, co-multiplication of two or more microbes occurs. This can happen accidentally, but not all microbes are able to grow independently from others; e.g. one of the microbes can produce a compound that enables the growth of another microbe in the culture medium (synergism), or a substance produced by one microbe inhibits the growth of another (antagonism), or one microbe can grow faster than the other, thus growth of the latter would be limited because of the use of essential nutrients. The microbiological examination of mixed cultures generally provides confusing and misleading results due to the different metabolic properties of various microbes. Therefore, it is necessary to create pure cultures. Pure (axenic) cultures are free from other microorganisms, develop from single cells or colony forming units, and serve as the basis of species level identification of bacteria and other studies.

Pure cultures can be obtained by the streak-plate technique. This method is based on the creation of a dilution gradient on the surface of an agar plate. Due to an appropriate dilution of the inoculum (e.g. mixed culture), discrete

and visible colonies can develop at the end of the inoculation line. Reisolation of bacterial cells from these colonies (originating from a single cell) onto agar slants results in pure cultures (Fig. 21).

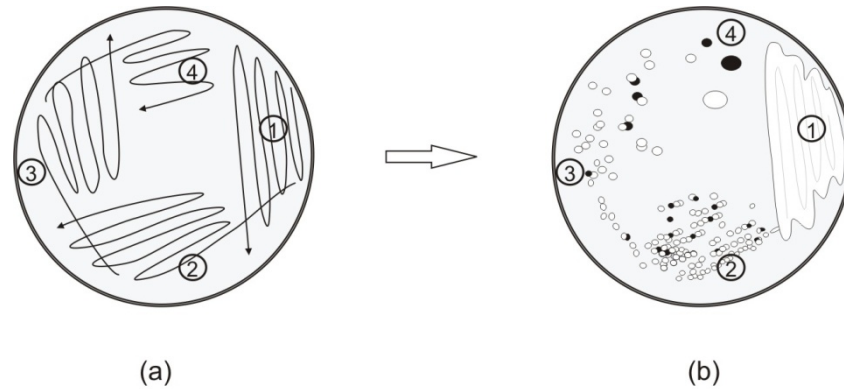

Fig. 21. Preparation of pure cultures by streak plate method. (a) Inoculate the mixed bacterial cultures on approximately one-quarter of the surface of an agar plate with the inoculating loop (1). Sterilise the loop by reflaming, cross over the streaks of the first inoculation when streaking the second part of the agar surface (2). Repeat these steps on the third (3) and fourth quarter (4) of the agar surface. (b) Check the growth of discrete colonies with different morphology, in this case colour, in the third and fourth quarter of the agar plate after the incubation period.

EXERCISE 28: PREPARATION OF PURE CULTURES BY THE STREAK PLATE METHOD

Object of study, test organisms:

mixed suspension of *Serratia marcescens* and *Micrococcus luteus* strains

Materials and equipment:

nutrient agar plates (see Appendix)
 inoculating loop
 Bunsen burner
 incubator

Practice:

1. Label a Petri plate to be inoculated with the date, your name, and the mark of the isolate to be purified.
2. Take the inoculating loop and hold it like a pencil. Flame the inoculating loop over a Bunsen burner until the wire becomes red-hot.
3. Holding the inoculating loop in one hand, take the test tube containing the suspension of mixed bacterial cultures in the other hand.
4. Using the same hand that is holding the inoculating loop, remove the cap from the test tube, hold it between your fingers, and briefly flame the neck of the tube over a Bunsen burner by passing through the flame.
5. Take a loopful of inoculum from the suspension.
6. Flame the neck of the tube again and close it with the cap. Place the tube in the rack.
7. Inoculate approximately one-third of the agar surface (at the edge) using the infected inoculating loop (without scratching the agar).
8. Sterilise the loop again by flaming until the wire becomes red-hot.
9. Cool the loop by thrusting it into the sterile agar.

10. Cross over the streaks of the first inoculation when streaking the second part of the agar surface.
11. Flame and cool the loop again before repeating the streaking process on the third part of the agar surface.
12. Sterilise the loop again by flaming and place it on the rack.
13. Incubate the culture at 28°C for one week.
14. Check the growth of discrete colonies with different morphology (see EXERCISE 35) after the incubation period. Perform re-isolation (see EXERCISE 27). (Fig. 21).

(See also Supplementary Figure S16.)

7.3.4. Anaerobic cultivation techniques

The appropriate method for the cultivation of anaerobes should be chosen with consideration of the sensitivity of the given organism to oxygen concentration and/or redox value within the media or the surrounding atmosphere. For the cultivation of bacteria sensitive to even trace amounts of oxygen (e.g. methanogens, sulphate reducing bacteria), the best technique is the use of an anaerobic system, filled with an appropriate gas, and the only contact with the outside world is through a sluice chamber that removes oxygen when materials are introduced into the system. Microbes that are not sensitive to trace amounts of oxygen and are able to survive temporarily high oxygen concentrations (e.g. sampling and sample processing) by forming endospores, can be cultivated in anaerobic jars or in semisolid media containing special reductive agents. However, colonies formed inside “anaerobic” agar deep tubes are difficult to examine and isolate. This problem can be solved by using Marino-plates (better known as Brewer’s plates), a combination of a Petri-dish and an “anaerobic” agar.

EXERCISE 29: CULTIVATION OF ANAEROBIC BACTERIA IN SODIUM THIOGLYCOLLATE MEDIUM

The oldest and most common method for the cultivation of anaerobic bacteria is culturing them deep in **reduced semisolid or solid media**. The most important property of these nutrient media is the suitably low redox potential. Different indicators within the culture media serve to test the appropriately low redox potential. The most common indicators are resazurin and methylene blue, which show colour only in an oxidised environment (where resazurin is red and methylene blue is blue). To ensure that oxygen does not get into the culture media either, the inoculated media are sealed during incubation (melted and heat sterilised vaseline, or 1:1 mixture of Vaseline and paraffin is layered on top of the culture media). Semi-solid agar deep tubes are prepared with a small amount of agar, so that these media are appropriate for the cultivation of anaerobes without sealing, since agar itself can reduce convection currents, thus reoxidation; furthermore agar colloid applied in small concentrations is reductive. To lower the redox potential in semisolid media even further, reductive compounds could be used (sodium thioglycollate and cysteine).

Object of study, test organisms:

anaerobic bacteria of soil

Materials and equipment:

soil sample
9 mL sterile distilled water in test tubes
vortex mixer
sodium thioglycollate containing melted agar medium (see Appendix)
pipette, sterile pipette tips
Bunsen burner
incubator

Practise:

1. Prepare a 10-fold dilution series from the soil sample (see EXERCISE 15) and pipette 1-1 mL from each dilution to sodium thioglycollate containing melted agar medium and label the tubes.
2. Incubate the tubes at 28°C for one week.

3. Check the colonies inside the test tube and count them if possible.

EXERCISE 30: CULTIVATION OF ANAEROBIC BACTERIA USING MARINO PLATES

Marino-plates provide a bigger surface area to examine the colony-forming properties of anaerobic bacteria and also make isolation easier.

Object of study, test organisms:

anaerobic bacteria of soil

Materials and equipment:

soil sample
9 mL sterile distilled water in test tubes
vortex mixer
melted semisolid “anaerobic” agar (see Appendix as thioglycollate agar)
sterile, glass Petri-dishes wrapped into foil
80° C water bath
pipette, sterile pipette tips
incubator

Practise:

1. Prepare a 6-member 10-fold dilution series from the soil sample.
2. Put the test tubes containing the dilution series into an 80°C water bath for 10 minutes to select for endospore-forming organisms.
3. Unwrap the glass Petri-dishes under a laminar flow box. Pipette 100 µl from a given dilution into the inner surface of the Petri-dish top. Then pour culture media (cooled down to approximately 45°C) into the Petri-dish and thoroughly mix the diluted sample with the nutrient medium. Put the bottom of the Petri-dish (which has a smaller diameter than the top) into the top before the medium solidifies; thus create a thin culture medium between the two parts of the Petri-dish.
4. Wrap the Marino-plates in foil again and incubate for at least 1-2 days up to one week depending on the results.
5. Examine the plates if bacterial growth can be detected. Observe the individual colonies under a stereo microscope and try to isolate some of the colonies by making stab cultures in agar deep tubes (thrusting an inoculating loop with bacteria deep down into the centre of the agar).

EXERCISE 31: CULTIVATION OF ANAEROBIC BACTERIA IN AN ANAEROBIC JAR

The anaerobic jar is usually transparent and can be sealed; contains a palladium catalyst, a disposable H₂+CO₂ generator and a redox indicator. Cultures are placed into the jar along with an envelope that includes two tablets. One of the tablets contains NaBH₄ that generates hydrogen when it reacts with water; the other tablet contains citric acid and sodium-hydrogen-carbonate that generates CO₂ when comes into contact with water. The CO₂ contributes to the growth of fastidious anaerobes. The jar is sealed after water is added to the envelope. In the presence of the palladium catalyst, hydrogen reacts with oxygen to form water. This reaction removes free oxygen from the inner atmosphere of the jar (Fig. 22). The colour change of the indicator refers to the formation of an anaerobic atmosphere.

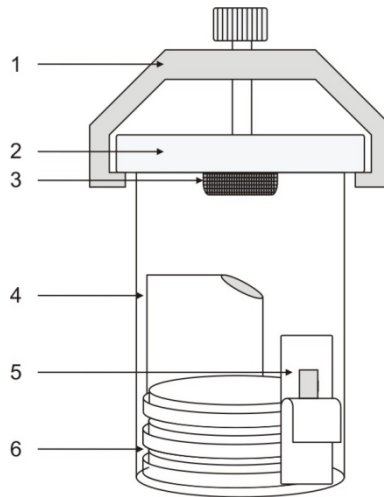

Fig. 22. The anaerobic jar. (1) clamp (2) cover (3) palladium catalyst (4) H₂+CO₂ generator (5) redox indicator (6) culture plates.

Object of study:

Clostridium spp. from soil

Materials and equipment:

soil or sediment sample
 9 mL sterile distilled water in test tubes
 vortex mixer
 anaerobic jar
 redox indicator strip
 gas generator envelope
 palladium catalyst
 scissors
 pipette, sterile pipette tips
 glass spreader (alcohol for sterilisation)
 bismuth sulphite agar medium (see Appendix as Wilson-Blair type agar)
 Bunsen burner
 incubator

Practise:

1. Prepare a 6-member 10-fold dilution series from soil sample.
2. Spread each member of the dilution series onto Wilson-Blair type agar medium.
3. Put the inoculated Petri-dishes with their surface down into the anaerobic jar (Fig. 22). Open the redox indicator and place it next to the plates so that the indicator strip can be seen from the outside (the indicator strip will turn blue within seconds).
4. Take care that palladium catalyst has been regenerated (by incineration) or replace with a fresh one.
5. Cut the gas generator envelope with scissors, and add 8-10 mL water with a pipette (according to the manufacturers' instructions). Close the jar and screw on the clamp, then put the jar into an incubator at 28°C.
6. After one week of incubation, determine the CFU number for the original sample (see EXERCISE 15).

EXERCISE 32: DEMONSTRATION OF THE ANAEROBIC CHAMBER (GLOVE-BOX)

The anaerobic chamber is a device suitable for the cultivation of strictly anaerobic bacteria (Fig.23). Inside the system, anoxic conditions can be maintained, while microbiological operations (microscopy, isolation, inoculation, etc.) can be performed. At first step, oxygen is removed with vacuum, then a gas mixture (10% H₂, 10% CO₂, 80% N₂) is introduced into the system with slightly positive pressure. The detection of trace amounts of oxygen is performed by methylene blue or resazurin redox indicators, and the elimination of such oxygen is completed by a palladium catalyst. Active carbon inside the anaerobic chamber serves to bind catalyst poisons (e.g. H₂S) and other substances that are toxic for bacterial cells.

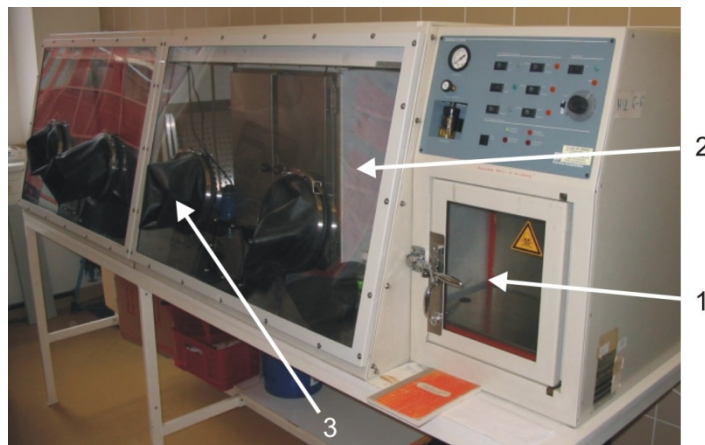

Fig. 23. The anaerobic chamber (glove box). Samples are transferred through the interchange (1) into the working chamber (2), where they can be handled from outside through gloves (3).

7.3.5. Transfer, maintenance and storage of pure cultures

The aim of strain maintenance is to keep microorganisms alive in such a way that their phenotype (and genotype) does not change relative to the original isolates. It is essential that microbial cells are not contaminated, keep their viability and their genetic material remains unchanged as much as possible during storage.

The maintenance of new environmental isolates as well as strains of described species can be done using different methods (e.g. subcultivation, lyophilisation, storage in liquid nitrogen). To select the appropriate technique, one must take into account several factors: aim of maintenance, intended duration, generation time of the microbes, etc.

EXERCISE 33: PROCEDURE OF CULTURE TRANSFER (SUBCULTURING)

During the maintenance of bacterial strains by transfer (or subculturing), cultures of bacteria are transferred to fresh sterile growth medium (usually to agar slants) at appropriate intervals, and the newly developed cultures are stored at 4-6°C (in a refrigerator or a cold room). This process should be repeated periodically (every few weeks or months) depending on the characteristics of bacterial strains (Fig. 24). The disadvantage of this method is that frequent passages may increase the risk of contaminations and mutations, and cultures may dry out during storage. In the case of storage for relatively long periods, to prevent cultures from desiccation and to reduce oxidative stress, slant surfaces should be covered with sterile mineral oil.

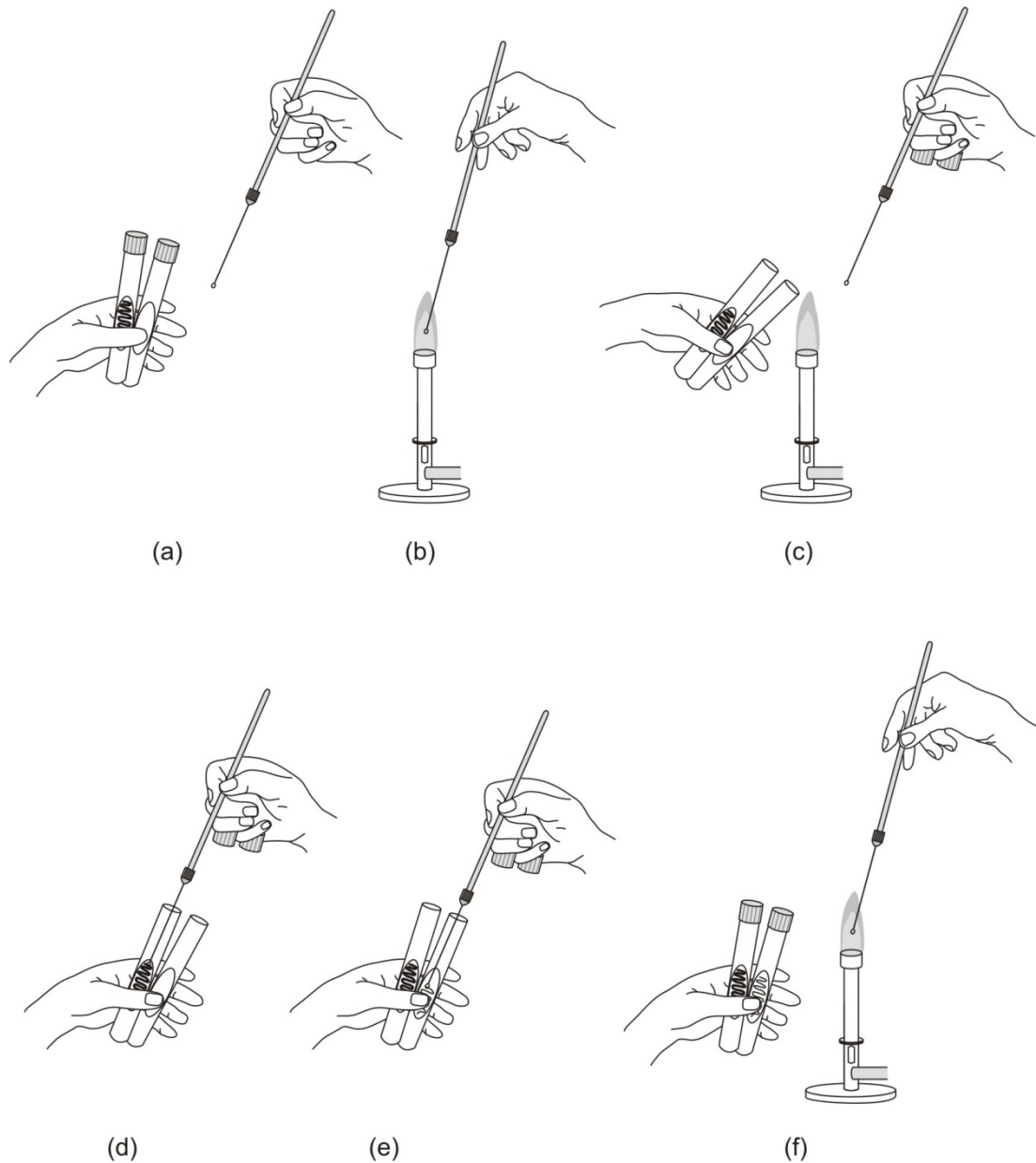

Fig. 24. Subculturing microbial cultures. (a) Place both test tubes in one hand to form a V-like shape. Take the inoculating loop in the other hand (b) and flame it over a Bunsen burner. (c) Remove the cap from the test tubes, and briefly flame the neck of the tubes. (d) Pick up a loopful of bacterial cells from the culture using the sterile inoculating loop, (e) and inoculate the surface of the sterile agar slant in zigzag streaks. (f) Reflame the necks of the tubes, close them and reflame the inoculating loop.

Object of study, test organisms:

slant culture of *Micrococcus luteus*
 slant culture of an unknown bacterial strain

Materials and equipment:

nutrient agar slants (see Appendix)
 inoculating loop
 Bunsen burner
 incubator

Practice:

1. Label a tube containing the sterile agar slant to be inoculated with the date, your name, and the name or mark of the test microorganism.
2. Place both test tubes (the sterile agar slant and that of containing the culture) in the palm of your hand in a V-like shape and stabilise them with your thumb. They should be held at an angle and thus not directly exposed to airborne laboratory contaminants.
3. Take the inoculating loop in the other hand and hold it like a pencil. Flame the inoculating loop along its full length over a Bunsen burner until the wire becomes red-hot.
4. Using the same hand that is holding the inoculating loop, remove the cap from the test tubes, hold it between your fingers, and briefly flame the neck of the tubes over a Bunsen burner by passing them through the flame. Do not put the caps onto the laboratory bench.
5. Cool the inoculating loop by pushing it against the top of the sterile agar slant until it stops “hissing.”
6. Pick up a loopful of bacterial cells from the culture using the sterile inoculating loop, and inoculate the surface of the sterile agar slant in zigzag streaks.
7. Flame the necks of the tubes and close them with their caps.
8. Sterilise the inoculating loop again by flaming.
9. Place the tubes and the inoculating loop into the rack.
10. Incubate at 28°C for one week.
11. Check the growth of the culture.
12. For storage, place the cultures at a cool place (at 4-6°C).

The common feature of most maintenance techniques is that FREE AVAILABLE water is removed from the culture and water uptake is not allowed during storage. Several “dry maintenance” techniques are available for microorganisms, especially for fungi. In the case of fungi, cultures are mixed with sterile medium, and then dried onto silica gel, paper strips or gelatine discs. This way, microbes can preserve their viability for many years. During the process of freezing, microbial cells become dehydrated, thereby water becomes unavailable for them. If the procedure is not performed adequately, the freezing and defrosting process can damage the microbial cells. The reasons are the increased concentration of electrolyte solution within the cells and the formation of ice crystals. The harmful effects can be reduced by adding cryoprotective substances, such as dimethyl sulfoxide (DMSO) and glycerol. Freezing techniques can be classified according to the applied temperature. In general, storage above -30°C is less effective. Using deep-freezing at -70°C, a wide variety of microorganisms (e.g. bacteria, fungi, viruses) can be stored for many years. Using liquid nitrogen at -196°C or nitrogen vapour at -140°C (ultra-freezing), the viability of such microorganisms can be successfully preserved for decades, where other methods have failed.

EXERCISE 34: MAINTENANCE OF BACTERIAL CULTURES WITH FREEZE-DRYING

Lyophilisation, or freeze-drying, is one of the oldest procedures used to maintain the viability of microorganisms even for decades. In the process of freeze-drying, first a suspension is prepared by adding cryoprotective agents (e.g. blood serum, inositol, sucrose, raffinose) to the culture, and then it is suddenly frozen. Subsequently the ice is sublimated under high vacuum so that the suspension cannot melt during the process of drying. Following drying, cultures are stored in sealed sterile vials.

The basic parts of a freeze-drying equipment (Fig. 25) are a vacuum pump and a chamber with a cooled wall to condense water. Most frequently, freezing of cell suspension takes place due to the heat loss caused by evaporation under vacuum. In this process, the samples are centrifuged in order to maximise the surface for evaporation and to avoid the formation of foam due to gas emissions. For this method, glass vials are used. The initial drying step is followed by a second, more thorough drying, also under vacuum. Alternatively, the samples can be put into glass tubes, frozen first and then dried under vacuum (the initial spin is skipped). In this case, CoCl₂ crystals are placed

along with the samples to indicate the presence of water (e.g. if hydration takes place due to the break or rupture of the glass, the blue colour of CoCl_2 changes to pink) (Fig. 25).

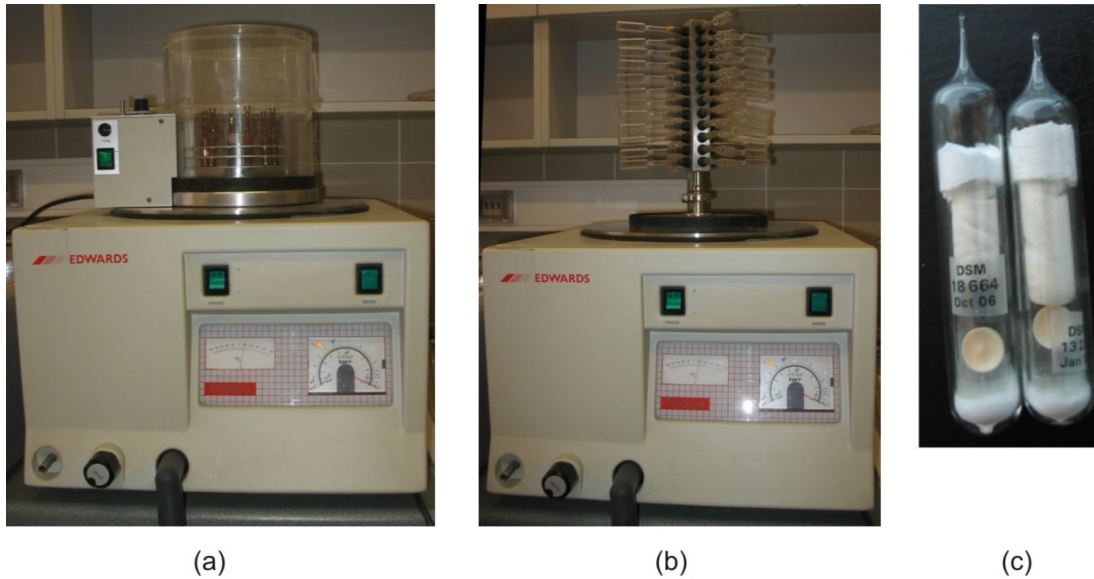

Fig. 25. Laboratory freeze-drying equipment. (a) Primary drying using a batch glass vial ampoule centrifuge. (b) Secondary drying, ampoules are attached to a drying manifold. (c) Lyophilised bacterial strains.

Object of study, test organisms:

culture of *Micrococcus luteus* on agar slant

Materials and equipment:

5% inositol broth
 inoculating loop
 Bunsen burner
 sterile Pasteur pipette
 sterile vials
 sterile cotton plug
 metal forceps
 sterile gauze

Practice:

1. Culture the test organism on the most appropriate medium and temperature until its stationary phase is reached, usually for 18-24 hours.
2. Pipette 1 mL of inositol broth onto the surface of the slant culture using a sterile Pasteur pipette and suspend the cells in it. Then pipette 0.3 mL of suspension into a sterile, labelled (date and name of microorganism) 10 mL ampoule. Flame the mouth of the ampoule, and loosely place a gauze plug into it.
3. Turn on the cooling of the freeze-drying equipment, and put the ampoules into the centrifuge when the temperature of the device is -45°C for at least 10 minutes.
4. Spin for 10 minutes. Turn on the vacuum pump (the gas ballast must be completely open) immediately after spinning has started, and close the valve.
5. Following approximately 1 hour of drying time, open the valve, and place the vials onto the post-drying device. A sudden pressure drop indicates when drying has ended.
6. Carefully melt and seal (close) the neck of the vial under vacuum.

7. Open the valve and switch off the vacuum pump and then the cooling device.

7.4. Pheno- and genotypic characterisation of bacterial strains

7.4.1. Colony- and cell morphology, staining procedures

EXERCISE 35: OBSERVING COLONY MORPHOLOGY ON INOCULATED PLATES

Microbes grow on solid media as colonies. A colony is defined as a visible mass of microorganisms originating from a (single) mother cell, therefore a colony constitutes a clone of bacteria all genetically identical (except mutations that occur at low frequency). The number of cells within a colony can even reach a few billion. On a given medium, a colony's shape, colour, consistency, surface appearance and size - for a given incubation time - are often characteristic, and these features are often used in the identification of particular bacterial strains (Fig. 26).

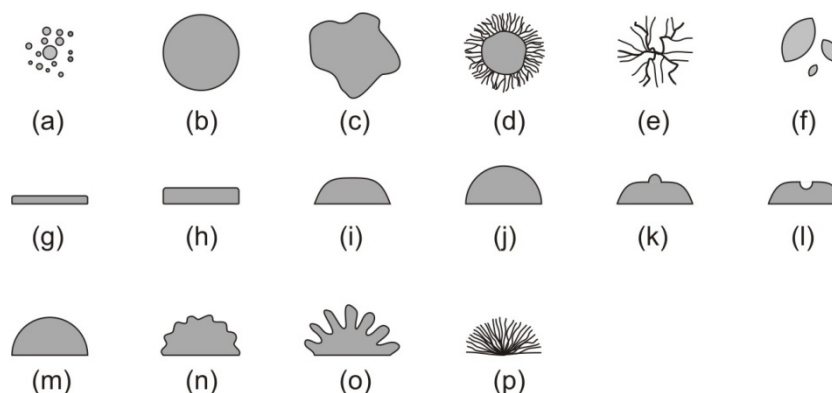

Fig. 26. Colony morphology of bacteria. Form: (a) punctiform (b) circular (c) irregular (d) filamentous (e) rhizoid (f) spindle. Elevation: (g) flat (h) raised (i) convex (j) pulvinate (k) umbonate (l) crateriform. Margin: (m) entire (n) undulate (o) lobate (p) filamentous.

Object of study, test organisms

agar plates with colonies originating from an environmental sample

Materials and equipment:

ruler
magnifying glass

Practise:

- Select 5 different discrete colonies from the surface of a Petri plate and characterise them as follows:
 - size of the colony (diameter in mm),
 - shape or form of the colony (punctiform, circular, irregular, filamentous, rhizoid, spindle),
 - elevation of the colony (flat, convex, pulvinate, umbonate, crateriform),
 - margin of the colony (entire, undulate, lobate, filamentous),
 - pigmentation of the colony (diffusible water-soluble or water-insoluble pigments),
 - surface of the colony (smooth, glistening, rough, dull, wrinkled),
 - density of colony (transparent - clear, opaque, translucent - almost clear, but distorted vision-like looking through frosted glass, iridescent - changes colour in reflected light),
 - consistency of colony by touching it with an inoculating loop (butyrous, viscid - sticks to loop, hard to get off, brittle - dry, breaks apart, mucoid),
 - presence or absence of diffusible pigment in the medium around the colony.

Characteristics of cell morphology have great importance in the classification of bacteria using traditional taxonomical methods. Microorganisms cannot be identified solely by morphological characteristics, since bacterial cells can only be assigned to a limited number of categories (**Table 1**). Bacteria are μm -sized organisms, where cell size is an important aspect of a thorough morphological characterisation. The size and shape of the cells are usually determined following staining. The circumstances of culturing, the age of the culture and the physiological condition of bacterial cells can alter cell size and shape. According to their shape, bacteria can usually be identified as rods, cocci or spirals. An average rod-shaped bacterium is 2-5 μm long and 0.5-0.8 μm wide in diameter. The average diameter of a sphere-shaped bacterium is 0.8 μm . The size of some bacterial groups deviates from average values: spirochetes include some extremely thin (0.2 μm) bacteria, while there are some giants: *Thiomargarita namibiensis* (100-300 x 750 μm) and *Epulopiscium fishelsoni* (50 x 600 μm).

Table 1. Morphology of bacterial cells

Coccus (sphere)		
Micrococcus	Following cell division, cells separate (singles)	<i>Micrococcus luteus</i>
Diplococcus	Following cell division, cells remain in pairs	<i>Neisseria gonorrhoeae</i>
Streptococcus	Chain of cocci	<i>Streptococcus lactis</i>
Staphylococcus	Grape-like cluster of cocci	<i>Staphylococcus aureus</i>
Tetragenus	Cell division on 2 planes, cocci in tetrads	<i>Planococcus</i>
Sarcina	Cell division on 3 planes, cocci in aggregates (packets) of eight	<i>Micrococcus luteus</i> (earlier “ <i>Sarcina lutea</i> ”)
Rod (bacillus)		
	Shape and size very variable: long-short, wide-thin, coccoid, irregular	<i>Bacillus megaterium</i> <i>Pseudomonas</i> sp. <i>Haemophilus influenzae</i> <i>Corynebacterium</i> sp.
Curved rod (spiral shape)		
Vibrio	Cell with quarter or half a turn	<i>Vibrio cholerae</i>
Spirillum	Rigid cell wall, motility with flagella, cell with one or more turns	<i>Spirillum volutans</i>
Spirochaeta	Flexible cell wall, endoflagella, cell with one or more turns	<i>Treponema pallidum</i>
Filamentous		
	Actinomyces have branching cells, forming bacterial hyphae and their network (mycelium)	<i>Streptomyces</i> sp., <i>Nocardia</i> sp.
Variable		
	Intermediate forms (e.g. rod-coccus life cycle)	<i>Rhodococcus</i> sp.

Most commonly, fixed and stained smears are used for the study of cell morphology, intracellular constituents and structures. The chemistry of simple staining is based on the principle that different charges attract, while similar charges repel each other. In an aqueous environment, at pH 7, the net electrical charge produced by most bacteria is negative. Dyes applied for staining could be acidic, basic and neutral dyes according to their chemical characteristics. Each dye contains a cation (positive charge) and an anion (negative charge) and either one could be the chromophore (the part of the molecule that is coloured). Since acidic dyes carry a negative charge on their chromophore, the bacterial cells (also negatively charged) reject these dyes. Negative staining could also be conducted with dyes having a colloidal particle size that therefore cannot enter the cell (e.g. the black coloured India Ink and Nigrosine). The chromophores of basic dyes have a positive charge and result the staining of bacterial cells (positive

dyes), since they bind to proteins and nucleic acids (around neutral pH carrying a negative charge). Basic dyes include safranin (red), methylene blue (blue), crystal violet (violet), malachite green (green).

Positive staining can be performed with only one dye (simple staining) or more dyes (complex staining). In case of complex staining, the first stain is called “primary stain” and the second one as “counterstain”.

Generally the steps of staining are as follows: degreasing and labelling of a slide, making a smear, fixation (occasionally missing), staining (in case of complex staining also includes counterstaining), washing with water, drying and microscopic observation.

EXERCISE 36: SIMPLE STAINING

Object of study, test organisms:

Staphylococcus aureus slant culture
Bacillus cereus slant culture
Pseudomonas aeruginosa slant culture
Optionally (strain descriptions see in chapter 16):
Wohlfahrtiimonas chitiniclastica (Supplementary Figure S1., S2.)
Ottowia pentelensis (Supplementary Figure S3.)
Tahibacter aquaticus (Supplementary Figure S4.)
Siphonobacter aquaeclarae (Supplementary Figure S5.)
Nocardioides hungaricus (Supplementary Figure S6.)
Nocardioides daphniae (Supplementary Figure S7.)
Aquipuribacter hungaricus (Supplementary Figure S8.)
Bacillus aurantiacus (Supplementary Figure S9.)
Bacillus alkalisediminis (Supplementary Figure S10.)
Cellulomonas phragmiteti
Pannonibacter phragmitetus (Supplementary Figure S11.)
Thermus composti (Supplementary Figure S12.)

Materials and equipment:

glass slide
glass dropper dispenser
inoculating loop
Bunsen burner
wooden test tube clamps
crystal violet dye solution (see Appendix)
safranin dye solution (see Appendix)
methylene blue dye solution (see Appendix)
light microscope
immersion oil
benzene
wad of paper

Practise:

1. Grip a glass slide with wooden test tube clamps, degrease the surface of a glass slide with alcohol over a Bunsen burner, put it down on a metal rack/staining stand with the degreased surface upwards, let it cool down.
2. Label the degreased slide adequately.
3. Put a small drop of water onto the slide (a well degreased slide will be wetted) and then mix a small loopful of bacterial culture in it. A thin suspension will be formed this way. Make a film layer (smear) with the needle of the inoculating loop and let it dry.
4. Fix your preparation with heat over the Bunsen burner.
5. Drop basic dye onto the fixed smear until it is fully covered and let it get stained for 1-2 minutes.

6. Wash the smear with tap water to remove excess dye solution.
7. Dry the slide.
8. During microscopy, first use 40x, then 100x objective lenses. In the latter case, use immersion oil. Make a drawing of the observed microscopic field.
9. After finishing microscopic observation, clean all used objective lenses with benzene (do not use alcohol for this purpose as it can dissolve the lens' adhesives).

EXERCISE 37: GRAM STAINING

This important bacteriological staining procedure was discovered in 1884 by a Danish scientist, Christian Gram. The staining is based on the cell wall structure of bacteria. When bacteria are stained with crystal violet, the cells of most Gram-negative bacteria can be easily decolourised with organic solvents such as ethanol or acetone, while cells of most Gram-positive bacteria restrict decolourisation (Fig. 27). The ability of bacteria to either retain or lose the stain generally reflects fundamental differences in the cell wall and is an important taxonomic feature. Gram staining is therefore used as an initial step in the identification of bacteria. The cells of some bacteria are strongly Gram-positive when young, but tend to become Gram-negative in ageing cultures (e.g. *Bacillus cereus*, *Clostridium* spp.), which may reflect degenerative changes in the cell wall. Some bacteria give a Gram-variable reaction: they are sometimes Gram-positive, sometimes Gram-negative; this could reflect minor variation in the staining technique or changes in cell wall thickness, etc.

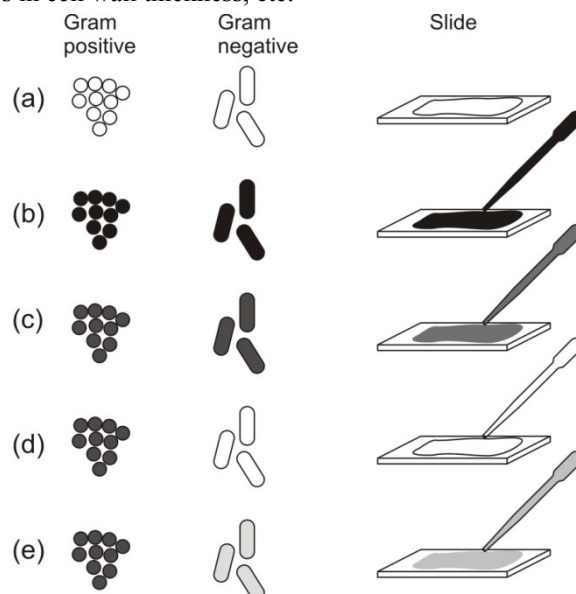

Fig. 27. Gram staining procedure. (a) Fix bacterial culture on a microscope slide. (b) Stain with crystal violet solution. (c) Treat with iodine solution. (d) Decolourise with 96% ethanol. (e) Counterstain with safranin solution.

Object of study, test organisms:

Staphylococcus aureus slant culture

Bacillus cereus slant culture

Pseudomonas aeruginosa slant culture

Optionally (strain descriptions see in chapter 16):

Wohlfahrtiimonas chitiniclastica (Supplementary Figure S1., S2.)

Ottowia pentelensis (Supplementary Figure S3.)

Tahibacter aquaticus (Supplementary Figure S4.)

Siphonobacter aquaeclarae (Supplementary Figure S5.)

Nocardioides hungaricus (Supplementary Figure S6.)

Nocardioides daphniae (Supplementary Figure S7.)

Aquipuribacter hungaricus (Supplementary Figure S8.)

Bacillus aurantiacus (Supplementary Figure S9.)

Bacillus alkalisediminis (Supplementary Figure S10.)

Cellulomonas phragmiteti

Pannonibacter phragmitetus (Supplementary Figure S11.)

Thermus composti (Supplementary Figure S12.)

Materials and equipment:

glass slide
glass dropper dispenser
pipette
inoculating loop
Bunsen burner
wooden test tube clamps
crystal violet dye solution (see Appendix)
iodine solution (Lugol's) (see Appendix)
96 % ethanol
safranin dye solution (see Appendix)
light microscope
immersion oil
benzene
wad of paper

Practise:

1. Prepare a fixed smear from the strains as described in EXERCISE 36.
2. Stain with crystal violet solution (1 min).
3. Rinse with tap water.
4. Treat with iodine solution (1 min).
5. Rinse with tap water.
6. Decolourise with 96 % ethanol (drip with ethanol until the solvent runs down colorless).
7. Rinse with tap water.
8. Counterstain with safranin solution (1 min).
9. Rinse with tap water.
10. Dry the slide.
11. Examine with microscope. Gram-positive cells are purple, while Gram-negative ones are pinkish-red. Make a drawing of the observed microscopic field.

(See also Supplementary Figures S17, S18, S19.)

EXERCISE 38: JAPANESE GRAM TEST

The Japanese Gram-test (Fig. 28) is an easy and quick method to distinguish bacteria with Gram-positive and Gram-negative cell walls. The principle of the reaction is that strong base destroys Gram-negative cell walls and a thin filament can be pulled from their disengaged DNA. In the case of Gram-positive cells, such an easy cell wall degradation is not possible.

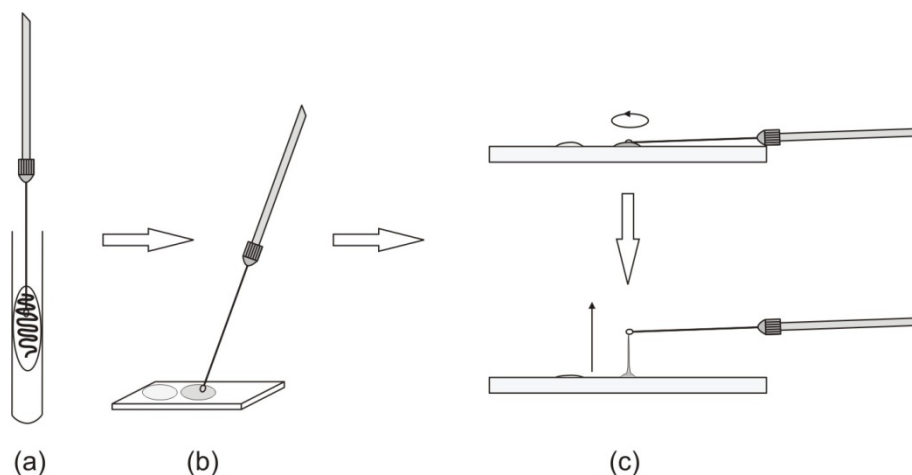

Fig. 28. Procedure of Japanese Gram test. (a) Place a loopful of bacterial culture (b) next to a drop of KOH solution on a slide. (c) Mix a small amount of KOH solution with the culture with the help of the inoculating loop and try to raise a thin filament from the culture. Gram-negative cells become slimy.

Object of study, test organisms:

Staphylococcus aureus 16-24-hour slant culture
Bacillus cereus var. *mycoides* 16-24-hour slant culture
Pseudomonas aeruginosa 16-24-hour slant culture
Escherichia coli 16-24-hour slant culture
 unknown bacterial strain 16-24-hour slant culture
 Optionally (strain descriptions see in chapter 16):
Ottowia pentelensis (Supplementary Figure S3.)
Nocardioides hungaricus (Supplementary Figure S6.)
Bacillus aurantiacus (Supplementary Figure S9.)
Bacillus alkalisediminis (Supplementary Figure S10.)
Cellulomonas phragmiteti (Supplementary Figure S11.)

Materials and equipment:

glass slide
 40 % KOH solution
 glass dropper dispenser
 inoculating loop
 Bunsen burner

Practise:

1. Take a clean slide with wooden test tube clamps.
2. Label the slide.
3. Put a small drop of KOH solution onto the slide, and then place a loopful of bacterial culture just beside the drop.
4. Mix with the inoculating loop a small amount of KOH solution with the bacteria and try to pick up a thin filament from the culture. Repeat this several times. Gram-negative cells become slimy, while the Gram-positive cell mass remains easily mixable.

EXERCISE 39: ZIEHL-NEELSEN ACID-FAST STAINING

The Ziehl-Neelsen staining is a complex and differential staining, which differentiates between acid-fast and non-acid-fast bacteria. Among acid-fast bacteria (e.g. *Mycobacterium* spp., *Nocardia* spp.), there are many pathogenic species. Acid-fast bacteria have a waxy substance, called mycolic acid, in their cell wall, which makes them imper-

meable to many staining procedures, including Gram staining. These bacteria are termed "acid-fast" because when stained, they are able to resist decolourisation with acid-alcohol. "Carbolfuchsin" stain contains phenol to help solubilise the cell wall. Heat is also applied during the primary staining to increase penetration. All cell types will take up the primary stain. The cells are then decolourised with acid-alcohol, which decolourises every cell except the acid-fast ones. Methylene blue is then applied to counterstain any cells that have been decolourised. At the end of the staining process, acid-fast cells will be reddish-pink, and non-acid fast cells will be blue.

Object of study, test organisms:

Rhodococcus rhodochrous slant culture
Mycobacterium phlei slant culture
unknown bacterial strain slant culture
Optionally (strain descriptions see in chapter 16):
Nocardioides hungaricus (Supplementary Figure S6.)
Nocardioides daphniae (Supplementary Figure S7.)

Materials and equipment:

glass slide
glass dropper dispenser
pipette
inoculating loop
Bunsen burner
wooden test tube clamps
carbolfuchsin dye solution (see Appendix)
acidic ethanol (see Appendix)
methylene blue dye solution (see Appendix)
pieces of filter paper (2 x 4 cm)
light microscope
immersion oil
benzene
wad of paper

Practise:

1. Prepare a fixed smear from the strains as described in EXERCISE 36.
2. Cover the smear with a piece of filter paper, and drop carbolfuchsin dye solution onto it (it must cover the entire preparation). Heat the slide over the flame until the liquid starts to turn into steam (aggressive staining). Reinstatate the steaming liquid permanently with dye and water. Perform aggressive staining for 10 minutes.
3. Carefully wash with tap water.
4. Wash with acidic ethanol.
5. Rinse with tap water.
6. Counterstain with methylene blue dye solution (1 min).
7. Rinse with tap water.
8. Dry the slide.
9. Examine with microscopy. Acid-fast bacteria will be violet-red, while non-acid-fast ones will be stained blue. Make a drawing of the observed microscopic field.

EXERCISE 40: SCHAEFFER-FULTON SPORE STAINING

Bacterial endospores are highly resistant structures with a thick wall formed by vegetative cells during a process called sporulation. They are highly resistant to radiation, chemical agents, extremely high temperatures, desiccation

and other harmful environmental effects. Several bacterial genera are capable of producing endospores; *Bacillus* and *Clostridium* are the two most common endospore-forming genera (Endospore morphology can be seen on Fig. 29).

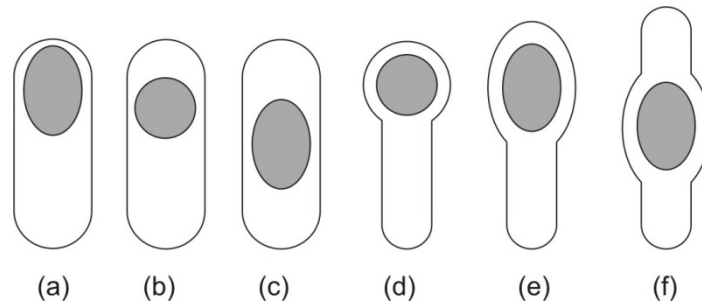

Fig. 29. Morphology of endospores. Location: terminal (a, d, e), subterminal (b), central (c, f). Shape: circular (b, d), ellipsoid (a, c, e, f). Spore diameter compared with cell diameter: non-deforming (a, b, c), deforming (d, e, f).

Due to the highly resistant nature of endospores, it is necessary to steam stain into them. The most common endospore staining technique is the Schaeffer-Fulton method. Once endospores have absorbed the stain, they are resistant to decolourisation, but vegetative cells are easily decolourised with water and counterstained with safranin to aid visualisation.

Object of study, test organisms:

Bacillus cereus slant culture
Saccharomyces cerevisiae slant culture
 unknown bacterial strain slant culture
 Optionally (strain descriptions see in chapter 16):
Bacillus aurantiacus (Supplementary Figure S9.)
Bacillus alkalisediminis (Supplementary Figure S10.)

Materials and equipment:

glass slide
 glass dropper dispenser
 pipette
 inoculating loop
 Bunsen burner
 wooden test tube clamps
 malachite green dye solution (see Appendix)
 safranin dye solution (see Appendix)
 pieces of filter paper (2 x 4 cm)
 light microscope
 immersion oil
 benzene
 wad of paper

Practise:

1. Prepare a fixed smear from the bacterial strains as described in EXERCISE 36.
2. Cover the smear with a piece of filter paper, and drop malachite green dye solution onto it (it must cover the entire preparation). Heat the slide over the flame until the liquid starts to turn into steam (aggressive staining). Reinstatate the steaming liquid permanently with dye and water. Perform aggressive staining for 10 min.
3. Thoroughly wash with tap water.
4. Counterstain with safranin dye solution (1 min).

5. Rinse with tap water.
6. Dry the slide.
7. Examine with a microscope. Endospores appear green meanwhile the vegetative cells are red. Make a drawing of the observed microscopic field.

(See also Supplementary Figure S20.)

EXERCISE 41: CAPSULE STAINING BY LEIFSON

Several bacteria have glycocalyx/capsule outside their cell walls. This layer protects the microbe against many environmental effects: desiccation, grazing by protozoons, attachment of phages, etc. Occasionally it is a kind of nutrient storage, which helps to concentrate the excreted enzymes or helps the cell to adhere to a specific surface. For pathogenic bacteria, it gives strong protection against the antibodies and macrophages of the host.

Usually the glycocalyx is built up from polysaccharides, uronic acids or proteins. The size and consistency of this layer can vary depending on the species, occasionally even on strains. Cultivation conditions also influence the production of glycocalyx. As the glycocalyx is not dense enough to be stained with simple staining methods, usually negative staining procedure (background staining) is adequate for this purpose. In this case, the particles of the applied colloidal dye cannot enter the glycocalyx, therefore they are strongly visible against the dark background (Fig. 30).

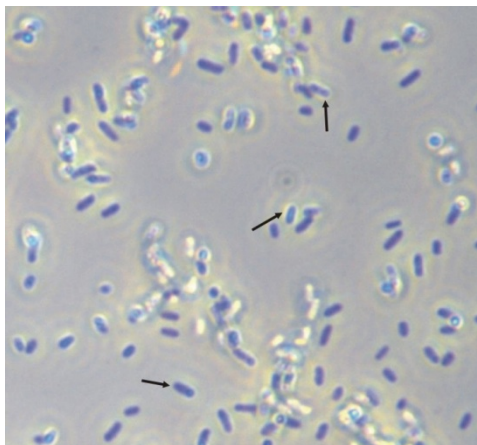

Fig. 30. Micrograph of the capsules in a flocculum of *Azotobacter* sp. Arrows indicate the capsules.

Object of study, test organisms:

Rhizobium sp. slant culture
Azotobacter vinelandii slant culture
Enterobacter sp. slant culture
unknown bacterial strain slant culture
Optionally (strain descriptions see in chapter 16):
Wohlfahrtiimonas chitiniclastica (Supplementary Figure S1., S2.)
Ottowia pentelensis (Supplementary Figure S3.)
Tahibacter aquaticus (Supplementary Figure S4.)
Siphonobacter aquaeclarae (Supplementary Figure S5.)
Aquipuribacter hungaricus (Supplementary Figure S8.)
Cellulomonas phragmiteti
Pannonibacter phragmitetus (Supplementary Figure S11.)
Thermus composti (Supplementary Figure S12.)

Materials and equipment:

glass slide
glass dropper dispenser

inoculating loop
 Bunsen burner
 wooden test tube clamps
 India ink and safranin dye solution (see Appendix)
 light microscope
 immersion oil
 benzene
 wad of paper

Practise:

1. Degrease a slide as described in EXERCISE 36.
2. Label the degreased slide.
3. Put a small drop of India ink solution onto the slide and then mix a loopful of bacterial culture in it - a thin suspension will be formed this way. Make a film layer (smear) with the needle of the loop and then let it dry.
4. Make a counter staining with safranin dye (staining the cells).
5. Examine with a microscope. Glycocalyx around bacterial cells appears as faint halo in the dark background. Make a drawing of the observed microscopic field (Fig. 30).

EXERCISE 42: HANGING DROP PREPARATION

Investigation of the movement of live bacteria by microscope is possible e. g. with hanging-drop preparation (Fig. 31). A suspension of microorganisms is placed in the centre of a cover slip and turned over with a special glass slide with a hollow depression in the centre. When observing live bacteria, be careful not to confuse motility with Brownian motion resulting from bombardment by water molecules. In Brownian motion, organisms all vibrate at about the same rate and maintain a relatively constant spatial relationship with one another, whereas bacteria that are definitely motile progress continuously in a given direction.

Motility can be observed most satisfactorily in young cultures (24 or 48 hours), because older cultures tend to become non-motile. An old culture may become so crowded with inert living and dead bacteria that it is difficult to find a motile cell. In addition, the production of acid or other toxic products may result in the loss of bacterial motility.

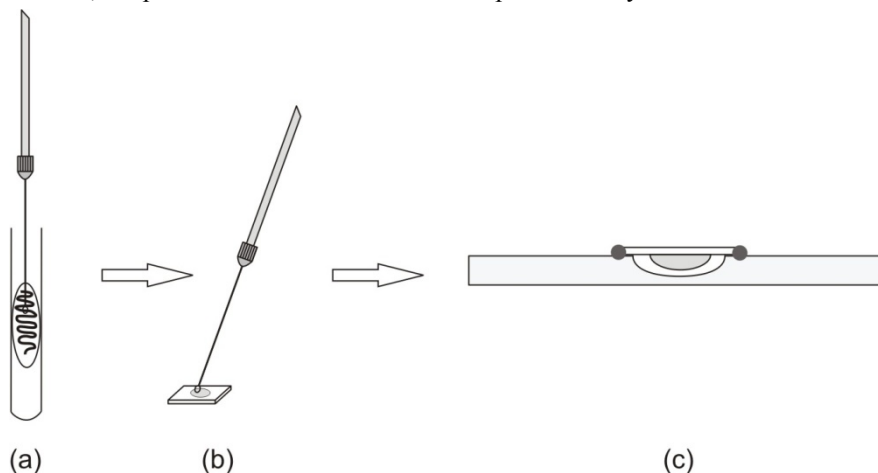

Fig. 31. Hanging drop preparation. (a) From the examined bacterial culture (b) prepare a weak suspension in a drop of water in the centre of a cover slip. (c) Put the glass slide with the hollow depression upside down over the cover slip preparation so that the drop of culture is in the centre of the depression, and then quickly turn it over.

Object of study, test organisms:

Pseudomonas aeruginosa 16-24-hour slant culture
Proteus vulgaris 16-24-hour slant culture
Staphylococcus aureus 16-24-hour slant culture

unknown bacterial strain slant culture

Optionally (strain descriptions see in chapter 16):

Wohlfahrtiimonas chitiniclastica (Supplementary Figure S1., S2.)

Ottowia pentelensis (Supplementary Figure S3.)

Tahibacter aquaticus (Supplementary Figure S4.)

Siphonobacter aquaeclarae (Supplementary Figure S5.)

Pannonibacter phragmitetus (Supplementary Figure S11.)

Thermus composti (Supplementary Figure S12.)

Materials and equipment:

glass slide with hollow depression

cover slip

inoculating loop

Bunsen burner

pipette, sterile pipette tips

light microscope

immersion oil

benzene

wad of paper

Practise:

1. Prepare a weak suspension from the examined bacterial culture in a small drop of water in the centre of a cover slip.
2. Put the glass slide with the hollow depression upside down over the cover slip preparation so that the drop of culture is in the centre of the depression, and then quickly turn it over.
3. Fix the cover slip to the slide with melted paraffin wax.
4. Examine with a microscope and estimate bacterial flagellation type, based on the movement of the cells.

EXERCISE 43: PREPARING SLIDE-CULTURES WITH HUMIDITY CHAMBERS

Micromorphology of microscopic fungi and actinobacteria can be studied with the help of slide-cultures (humidity chambers). Moulds are microscopic fungi that produce hyphae/mycelia submerged into the nutrient solution or agar medium (substrate- and aerial mycelia). Members of the Ascomycota lineage include not only yeasts but also many moulds important in food industry. The hyphae of these moulds are compartmentalised, mycelia are haploid. They reproduce by ascospores, which develop inside the ascus. In case of the genus *Aspergillus*, the tip of the conidium holders form a bulb, where sterigma can be found in radial direction. From each sterigma, the conidia branch off chainlike. The conidium holder of the genus *Penicillium* is branching, looks like a brush (Fig. 32).

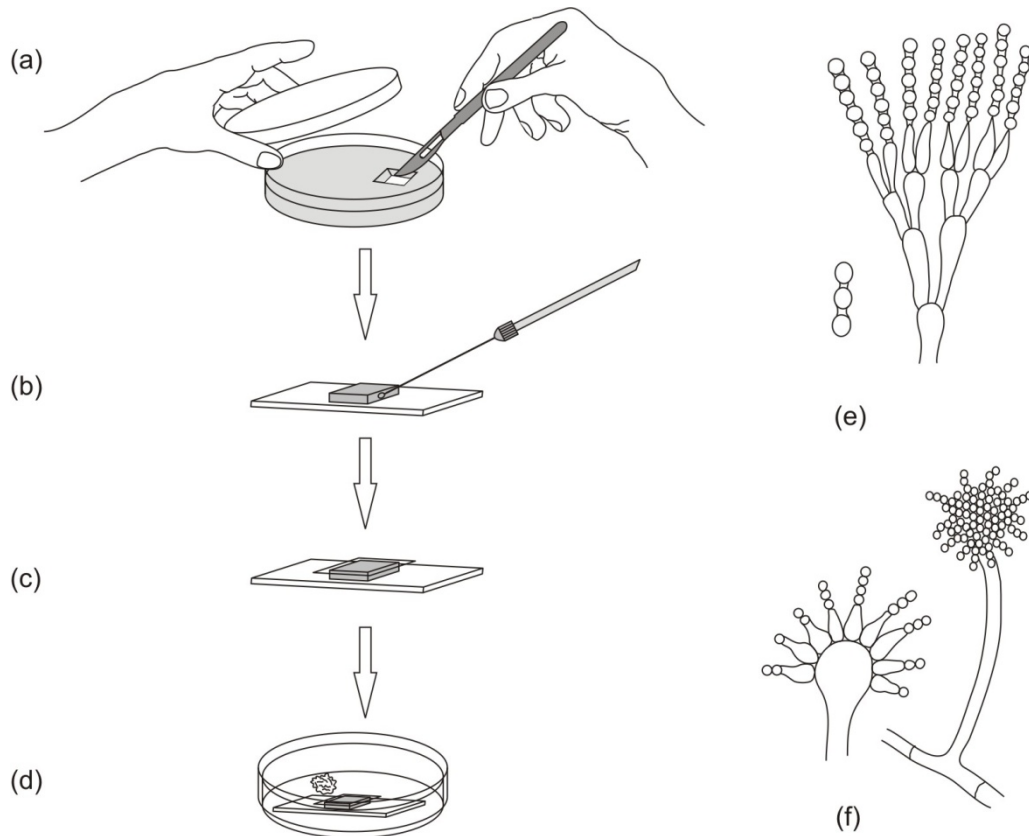

Fig. 32. Slide culture preparation. (a) Using a sterile scalpel, cut out 1.5 x 1.5 cm blocks of the adequate plate medium, and place it onto the previously sterilised glass slides. (b) Inoculate the margin of the agar blocks with a loopful of microorganism and (c) then place a sterile cover slip onto their surface. (d) Place also a moist cotton swab into the Petri dish next to the slide, forming a small humidity chamber this way. After the incubation, slide cultures can be studied directly under a microscope. Microscopic view of conidiophore and conidia: (d) *Penicillium* sp. and (e) *Aspergillus* sp.

Object of study, test organisms:

Aspergillus niger culture
Penicillium chrysogenum culture
Streptomyces sp. culture

Materials and equipment:

malt extract plate (see Appendix)
 Czapek plate (see Appendix)
 starch-casein plate (see Appendix)
 sterile glass slides and cover slips in sterile glass Petri dish
 scalpel
 sterile moist cotton swab
 Bunsen burner
 incubator

Practise:

1. Using a sterile scalpel, cut out 1.5 x 1.5 cm blocks of the adequate plate medium, and place it onto the previously sterilised glass slides (in the sterile Petri dish). For *Aspergillus niger*: malt extract, for *Penicillium chrysogenum*: Czapek and for *Streptomyces* sp.: starch-casein media should be used.
2. Inoculate the margin of the agar blocks with a loopful of microorganism and then place a sterile cover slip onto their surface.

3. Place also a moist cotton swab into the Petri dish next to the slide, forming a small humidity chamber this way.
4. Incubate at 28°C for one week.
5. After the incubation, slide cultures can be studied directly under a microscope. Make drawings about your observations.

7.4.2. Study of bacterial enzymes

Microorganisms, like all living organisms, may modify their environment to some extent, they can use chemicals as source of energy or as building blocks for growth and reproduction. With biochemical tests, it is possible to determine which substrates can be utilised by the given bacterial strain or what kinds of products are generated through their metabolism. The chemical end-products of some enzymatic reactions can be measured, or in other cases, the disappearance of certain substances from the medium can be detected. Reactions that a species can perform are determined genetically. Enzymes alter the rate of chemical reactions, generally making them faster. Enzymes located inside the cells are called endoenzymes or intracellular enzymes. Those excreted by the cell and working outside the cells are exoenzymes or extracellular enzymes. Making a series of different tests, a pattern of activity can be established (which in turn reflects the enzymatic makeup of the microorganisms), and this fingerprint aids in the identification of the microorganism.

In chemotrophic organisms, energy can be produced by the cell through oxidation, which is accomplished primarily by the removal of hydrogen and electrons. Electron is removed from the substrate (the substance is oxidised) and transported via various enzymes to a final electron acceptor. The transfer of electron is carried out through a series of oxidation-reduction reactions. Whether a cell respire or ferments depends generally on the presence of respiratory chain, the use of terminal electron acceptors and the presence of the enzymes necessary to reduce them. Obligate aerobes require atmospheric oxygen as a final electron acceptor. Studying the respiratory chain and relation of bacteria to oxygen are key characteristics during the identification of bacteria.

EXERCISE 44: CATALASE ACTIVITY

Many microbes contain flavoproteins and other so-called “two electron” and “one electron” carrier molecules, which reduce molecular oxygen to hydrogen peroxide or superoxide. Many bacteria are able to protect themselves against these toxic intermediates. Obligate aerobic and facultative anaerobic microbes (e.g. Enterobacteriaceae) produce superoxide dismutase and **catalase**, while aerotolerant anaerobes (e.g. *Streptococcus* spp.) produce superoxide dismutase and peroxidase enzymes.

Catalase is an enzyme found in most bacteria, and prevents the accumulation of toxic levels of hydrogen peroxide by the catalyzation of its breakdown to water and oxygen. Hydrogen peroxide is toxic to cells. It is a common by-product of metabolic reactions that take place in the presence of water and oxygen (e.g. that are related to the electron transport pathway). Therefore, most organisms that are able to survive in an atmosphere containing oxygen produce enzymes to degrade the peroxide. Catalase negative organisms tend to be anaerobic. Important catalase negative genera are *Streptococcus*, *Leuconostoc*, *Lactobacillus*, *Clostridium* and *Mycoplasma*.

Object of study, test organisms:

unknown bacterial strain 24-hour slant culture
Proteus vulgaris strain 24-hour slant culture
Micrococcus luteus strain 24-hour slant culture
Bacillus cereus strain 24-hour slant culture
Escherichia coli strain 24-hour slant culture
 Optionally (strain descriptions see in chapter 16):
Wohlfahrtiimonas chitiniclastica (Supplementary Figure S1., S2.) 24-hour slant culture
Ottowia pentelensis (Supplementary Figure S3.) 24-hour slant culture
Tahibacter aquaticus (Supplementary Figure S4.) 24-hour slant culture
Siphonobacter aquaeclarae (Supplementary Figure S5.) 24-hour slant culture
Nocardioides hungaricus(Supplementary Figure S6.) 24-hour slant culture
Nocardioides daphniae(Supplementary Figure S7.) 24-hour slant culture
Aquipuribacter hungaricus (Supplementary Figure S8.) 24-hour slant culture
Bacillus aurantiacus (Supplementary Figure S9.) 24-hour slant culture

Bacillus alkalisediminis (Supplementary Figure S10.) 24-hour slant culture
Cellulomonas phragmiteti 24-hour slant culture
Pannonibacter phragmitetus (Supplementary Figure S11.) 24-hour slant culture
Thermus composti (Supplementary Figure S12.) 24-hour slant culture

Materials and equipment:

3% H₂O₂ solution

Practise:

1. Add a few drops of 3% H₂O₂ solution to 24-hour slant cultures.
2. If the strain is catalase positive, the oxygen gas formed can be readily seen as white froth.

EXERCISE 45: OXIDASE ACTIVITY

Oxidase is an enzyme that reduces (adds electrons to) oxygen. Cytochrome oxidase is the final enzyme in the respiratory electron transport system. This enzyme receives electrons and passes them on to oxygen, resulting in the formation of water. Many bacteria that live in the presence of oxygen produce cytochrome oxidase (e.g. Gram-negative rods like *Pseudomonas* and closely related bacteria), while some lack this enzyme (e.g. members of the family Enterobacteriaceae). Usually, to detect oxidase activity, a test strip (impregnated with the oxidase reagent) is smeared with the bacterial culture. In the case of a positive test, oxidised cytochrome oxidises tetramethyl-p-phenylenediamine to form a purplish-blue product.

Object of study, test organisms:

unknown bacterial strain 24-hour slant culture
Proteus vulgaris strain 24-hour slant culture
Micrococcus luteus strain 24-hour slant culture
Bacillus cereus strain 24-hour slant culture
Escherichia coli strain 24-hour slant culture
Optionally (strain descriptions see in chapter 16):
Wohlfahrtiimonas chitiniclastica (Supplementary Figure S1., S2.) 24-hour slant culture
Ottowia pentelensis (Supplementary Figure S3.) 24-hour slant culture
Tahibacter aquaticus (Supplementary Figure S4.) 24-hour slant culture
Siphonobacter aquaeclarae (Supplementary Figure S5.) 24-hour slant culture
Nocardioides hungaricus(Supplementary Figure S6.) 24-hour slant culture
Nocardioides daphniae(Supplementary Figure S7.) 24-hour slant culture
Aquipuribacter hungaricus (Supplementary Figure S8.) 24-hour slant culture
Bacillus aurantiacus (Supplementary Figure S9.) 24-hour slant culture
Bacillus alkalisediminis (Supplementary Figure S10.) 24-hour slant culture
Cellulomonas phragmiteti 24-hour slant culture
Pannonibacter phragmitetus (Supplementary Figure S11.) 24-hour slant culture
Thermus composti (Supplementary Figure S12.) 24-hour slant culture

Materials and equipment:

sterile empty Petri dish with filter paper
oxidase reagent (1% tetramethyl-p-phenylenediamine solution)
Platinum inoculating loop
Bunsen burner

Practise:

1. Impregnate a filter paper with a drop of oxidase reagent.
2. Smear the test microorganism onto the impregnated surface using platinum inoculating loop. (do not use ordinary inoculating loops, since the Fe²⁺ ions can interfere with the test and give a false positive reaction; use one made of Platinum, or use a glass rod).

3. If you observe purplish blue coloration within 30-60 sec, it may be considered a positive reaction, while coloration that forms later than 1 min is considered a negative one.

EXERCISE 46: METHYLENE BLUE REDUCTION

Some bacteria are able to use **methylene blue** as a terminal electron acceptor when oxygen is not present. Exhaustion of oxygen from the broth during bacterial growth causes the colour to disappear because methylene blue is reduced to colourless leuco-methylene blue.

Object of study, test organisms:

unknown bacterial strain 24-hour slant culture
Escherichia coli strain 24-hour slant culture

Materials and equipment:

methylene blue broth (see Appendix)
 inoculating loop
 Bunsen burner
 incubator

Practise:

1. Inoculate a loopful of bacteria aseptically into methylene blue broth.
2. Incubate at 28°C for one week.
3. The test is positive if the blue colour starts to disappear from the bottom of the tube. If the broth is shaken rigorously, the blue coloration will reappear since oxygen can dissolve back into the broth.

Different **biopolymers** (proteins, polysaccharides, nucleic acids, fats) can be taken up by bacteria only after degradation into their mono- or oligomers. Therefore, the utilisation of different substrates depends strongly on the biopolymer degrading enzyme activity of bacteria (Fig. 33).

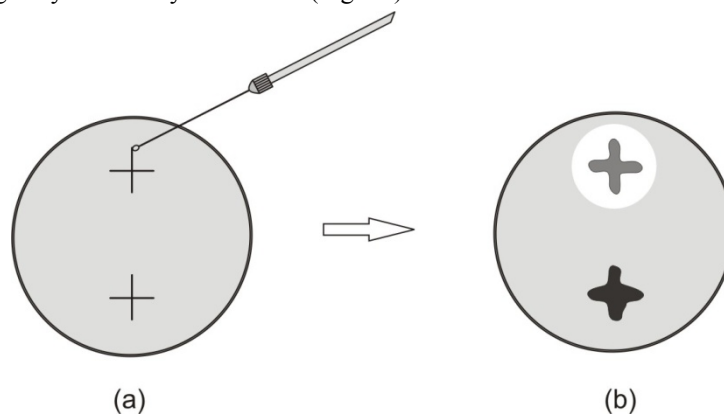

Fig. 33. Biopolymer degradation by bacteria. (a) Make a cross-inoculation on the surface of the agar plate containing biopolymer (e.g. skim milk). (b) After the incubation period, colonies of organisms able to digest the biopolymer (e.g. casein) will be surrounded by clear zones.

EXERCISE 47: CASEASE ACTIVITY

Object of study, test organisms:

unknown bacterial strain 24-hourslant culture
Micrococcus luteus strain 24-hourslant culture

Materials and equipment:

casein-containing plate - skim milk agar plate (see Appendix)
inoculating loop
Bunsen burner
incubator
acidic HgCl₂ solution (see Appendix)

Practise:

1. Make a cross-inoculation (making an X with the loop) on the surface of a skim milk agar plate.
2. Incubate at 28°C for one week.
3. After incubation, colonies of organisms that are able to digest casein (proteolytic microbes) will be surrounded by clear zones. Areas in which casein has not been degraded will remain slightly opaque.
4. In some cases, a false positive reaction could result if casein is only partially degraded into paracasein, which also exhibits a clear zone (zone of degradation). To eliminate such incorrect readings of the results, pour acidic HgCl₂ solution onto the surface of the milk agar plate. This will denature proteins along with the paracasein so only areas where full proteolysis has occurred will remain clear.

EXERCISE 48: GELATINASE ACTIVITY

The protein gelatine is a water-soluble mixture of polypeptides that can be obtained through boiling from the connective tissues and tendons of animals. The substance has a gel-forming characteristic. Many bacteria are capable of producing gelatinase, which hydrolyses gelatine and breaks down gelatine to utilizable amino acids.

Object of study, test organisms:

unknown bacterial strain 24-hour slant culture

Materials and equipment:

gelatine agar plate (see Appendix)
inoculating loop
Bunsen burner
incubator
acidic HgCl₂ solution

Practise:

1. Make a cross-inoculation (making an X with the loop) on the surface of a gelatine agar plate.
2. Incubate at 28°C for one week.
3. Flood the agar plates with acidic HgCl₂ solution. Within minutes, the HgCl₂ denatures proteins, forming an opaque precipitate with gelatine. Clear zones will appear where the gelatine has been hydrolysed.

EXERCISE 49: α-AMYLASE ACTIVITY

Starch is a polysaccharide that is abundant in nature and also a rich source of carbon and energy. It is a common carbohydrate reserve supplying the nutritional need of plant roots and seeds. However, the polysaccharide is too large to cross bacterial cell walls or cell membranes. Amylases cleave large starch molecules into monosaccharide and disaccharide units that are small enough to enter the bacterial cell. There, sugars are degraded by endoenzymes, releasing energy and carbon.

Object of study, test organisms:

unknown bacterial strain 24-hour slant culture

Materials and equipment:

starch agar plate (see Appendix)
inoculating loop
Bunsen burner
incubator
iodine solution (Lugol's) (see Appendix)

Practise:

1. Make a cross-inoculation (making an X with the loop) on the surface of a starch agar plate.
2. Incubate at 28°C for one week.
3. Flood the agar plates with iodine solution. Evaluation of the results is based on the reaction of starch with iodine, which gives a deep blue coloration. Clear zones around the inoculated area indicate a positive reaction, where amylase enzyme has hydrolysed starch.

EXERCISE 50: LYPOLYTIC ACTIVITY (TWEEN 80 HYDROLYSIS)

Lipids can be found in cell membranes, and they are common nutrient storage compounds. Forms of lipids, triglycerides are esters of glycerol and fatty acids. Esters could be hydrolysed by esterase enzymes, and the most common method to demonstrate esterase activity is the Tween 80 hydrolysis test (Tween 80 is the oleic acid ester of a polyoxyethylene derivative of sorbitan).

Object of study, test organisms

unknown bacterial strain 24-hour slant culture

Materials and equipment:

Tween 80 agar plate (see Appendix)
inoculating loop
Bunsen burner
incubator

Practise:

1. Make a cross-inoculation (making an X with the loop) on the surface of a Tween 80 agar plate.
2. Incubate at 28°C for one week.
3. After incubation, evaluate the results on the basis of the presence or absence of Ca-oleate crystals around the area of inoculation. In the case of a positive reaction, the hydrolysis of Tween frees oleic acid, and the calcium ions present in the medium form Ca-oleate precipitation zones (crystals) around the inoculated area.

EXERCISE 51: NUCLEASE (DN-ASE) ACTIVITY

Certain microbes can use the high molecular weight nucleic acids as nutrient source with their nuclease activity.

Object of study, test organisms:

unknown bacterial strain 24-hour slant culture

Materials and equipment:

DNA-containing agar plate (see Appendix)
inoculating loop
Bunsen burner
incubator
1N HCl solution

Practise:

1. Make a cross-inoculation (making an X with the loop) on the surface of a DNA-containing agar plate.
2. Incubate at 28°C for one week.
3. Pour 1N HCl solution onto the surface of the plate. The acid denatures and precipitates DNA, so where the reaction is positive and DNA has been hydrolysed, there will be clear zones around the inoculated area. The test is negative if no clear zone is visible around the cross-inoculation.

Carbohydrate metabolism is one of the most important metabolic features of microbes. The oxidation–fermentation test is used to distinguish between fermentation (oxygen is not necessary) and aerobic respiration (oxygen is used as terminal electron acceptor). The method applies semisolid agar medium containing sugar (glucose) and bromothymol blue indicator (which changes from blue to green and to yellow when the environment becomes acidic). For each test, two agar deep tubes are needed: an aerobic and a fermentative tube, the latter is sealed with a thick layer of sterile paraffin oil to prevent oxygen penetrating the medium.

EXERCISE 52: HUGH-LEIFSON TEST

Object of study, test organisms:

unknown bacterial strain 24-hour slant culture

Materials and equipment:

Hugh-Leifson semisolid agar deep tubes: one oxidative and one fermentative (sealed with paraffin oil), both of bluish-green colour (see Appendix)
inoculating loop
Bunsen burner
incubator

Practise:

1. Inoculate both the oxidative and the fermentative tubes with a loopful of the given bacteria by making a stab inoculation deep inside the agar tubes. When inoculating the fermentative agar deep, stab through the paraffin oil layer. Care should be taken because during the sterilisation of the inoculating loop the adhering paraffin oil might catch fire and squirt.
2. Incubate the tubes at 28°C for one week.
3. Evaluation of the results is as follows. *Fermentation*: Fermentation of the glucose starts at the most anaerobic part of the tube (the bottom) so read the fermentative agar deep tube from the bottom. Yellow coloration at the bottom of the fermentative tube indicates a weak positive reaction. Acid is formed in both tubes for fermentation. *Oxidation*: Aerobic utilisation of glucose starts at the most aerobic part of the media (top of the tube), therefore start the readings of the oxidative tube from the top. Yellow coloration in the upper portion of the tube indicates the aerobic utilisation of glucose.

(See also Supplementary Figure S28, S29.)

EXERCISE 53: METHYL RED-VOGES-PROSKAUER REACTION

This test is performed in MR–VP Medium containing glucose, peptone, phosphate buffer and methyl red indicator. This MR–VP test is used to identify organisms able to produce acetoin (acetyl-methyl-carbinol) from the degradation of glucose during 2,3-butanediol fermentation, moreover provides indication on the acidity of the medium (methyl red changes from yellow to red at pH ~4.4). Both the MR and VP tests are especially useful in differentiating members of the Enterobacteriaceae family.

Object of study, test organisms:

unknown bacterial strain 24-hour slant culture

Materials and equipment:

MR-VP broth (see Appendix)
inoculating loop
Bunsen burner
 α -naphthol (Barritt's reagent A) (see Appendix)
40% KOH (Barritt's reagent B) (see Appendix)
empty test tube
methyl red indicator (see Appendix)
incubator

Practise:

1. Inoculate a loopful of the test microbe into the MR-VP broth.
2. Incubate the tubes at 28°C for one week.
3. When evaluating the results, take 1 mL of sample into an empty test tube.
4. Add 2 drops of Barritt's reagent A and Barritt's reagent B to the sample. After shaking the tube gently for aeration, a change into red color after approximately 20 minutes will indicate a positive VP reaction. Add 3-4 drops of methyl red indicator solution to the remaining MR-VP medium. Lasting red coloration is considered to be positive for MR reaction (i.e. medium pH is below ~4.4).

(See also Supplementary Figure S30.)

EXERCISE 54: AESCULIN HYDROLYSIS

Aesculin (β -glucose-6,7-dihydroxycoumarin) hydrolysis is a useful test in the differentiation of both Gram-positive and Gram-negative bacteria. Hydrolysis is indicated by the production of a brownish-black coloured compound, due to the combination of ferric ions (Fe^{3+}) with the hydrolysis product aesculetin (6,7-dihydroxycoumarin) as indicator.

Object of study, test organisms:

unknown bacterial strain 24-hour slant culture

Materials and equipment:

aesculin broth (see Appendix)
inoculating loop
Bunsen burner
incubator

Practise:

1. Inoculate a loopful of the test microbe into aesculin broth.
2. Incubate the tubes at 28°C for one week.
3. A blackish, dark brown complex is formed in the test tube if the test is positive. If there is no such dark coloration, the test is negative.

EXERCISE 55: H₂S PRODUCTION

Bacteria that produce the enzyme cysteine desulhydrase are able to strip the amino acid cysteine of both its sulfhydryl (-SH) and amino groups. The reaction yields hydrogen sulfide (H₂S), ammonia (NH₃) and pyruvic acid. Hydrogen sulphide reacts with heavy metals (such as lead or iron) to form a visible, black precipitate.

Object of study, test organisms:

unknown bacterial strain 24-hour slant culture

Materials and equipment:

peptone broth (see Appendix)
inoculating loop
filter paper impregnated with lead(II)-acetate [Pb(CH₃COO)₂]
fume hood
Bunsen burner
incubator

Practise:

1. Inoculate a loopful of the test microbe into a cysteine-containing broth.
2. Place the test stripe (filter paper impregnated with lead acetate) into the tube at 5-10 mm over the surface of the broth, so that it does not immerse in the liquid medium and is fixed between the cap or plug and the surface of the test tube (Work in a fume hood and use gloves when handling the filter paper, since lead is toxic!).
3. Incubate the tubes at 28°C for one week.
4. Examine the filter paper. The test is positive if the paper turns black, the test is negative if there is no coloration on the filter paper.

EXERCISE 56: INDOLE TEST

Some bacteria hydrolyse tryptophan to pyruvic acid, which is subsequently metabolised. A by-product of that hydrolysis is indole, which is excreted by the organism. Pure tryptophan is not ordinarily used in the test medium. Instead, tryptone (a digestion product of certain proteins) is used, since it contains a considerable amount of tryptophan.

Object of study, test organisms:

unknown bacterial strain 24-hour slant culture

Materials and equipment:

peptone broth (see Appendix)
inoculating loop
Bunsen burner
Kovács' reagent (see Appendix)
incubator

Practise:

1. Inoculate peptone broth with the test microbe.
2. Incubate the tubes at 28°C for one week.
3. Add 0.2 mL of Kovács' reagent to the test tube, mix well and incubate for about 5 minutes. A positive test is indicated by a red coloration in the surface alcohol layer. The test is negative if the surface alcohol layer is yellow.

EXERCISE 57: PHOSPHATASE ACTIVITY

Many microbes have phosphatase activity, i.e. they liberate inorganic phosphate from compounds. In food industry the phosphatase test is often used to differentiate coagulase-positive Staphylococci as this method is less time consuming (there is a high degree of correlation between phosphatase and coagulase production).

Object of study, test organisms:

unknown bacterial strain 24-hour slant culture

Materials and equipment:

Na-phenolphthalein-phosphate agar plate (see Appendix)
inoculating loop
Bunsen burner
cc. ammonium solution
incubator

Practise:

1. Inoculate a loopful of the test microbe onto the surface of a Na-phenolphthalein-phosphate agar plate.
2. Incubate the plates at 28°C for one week.
3. Turn the agar plates upside-down and pipette a drop of ammonium solution into the top of the Petri-dish. If the test bacteria are phosphatase-positive, free phenolphthalein liberated by the phosphatase reaction reacts with ammonia and phosphatase-positive colonies become bright pink. If the test is negative, there is no visible colour change.

EXERCISE 58: HAEMOLYSINE PRODUCTION

The majority of bacterial pathogens produce erythrocyte destroying (haemolytic) enzymes. There are two types of haemolysis: α -, and β -haemolysis. If the erythrocytes are completely destroyed, the bacterial colonies are surrounded by clear zones on blood agar plates; this is the case of β -haemolysis. In the other case (α -haemolysis), a greenish-brownish zone is visible around the inoculated area, which can be accounted for the partial haemolysis of red blood cells.

Object of study, test organisms:

unknown bacterial strain 24-hour slant culture
Escherichia coli 24-hour slant culture
Enterococcus faecalis 24-hour slant culture
Staphylococcus aureus 24-hour slant culture
Streptococcus sp., 24-hour slant culture
Bacillus subtilis 24-hour slant culture

Materials and equipment:

blood agar plate (see Appendix)
inoculating loop
Bunsen burner
incubator

Practise:

1. Cross inoculate (making an X with the loop) the surface of a blood agar plate.
2. Incubate at 28°C for one week.
3. Determine the type of haemolysis based on the zone around the inoculated area.

EXERCISE 59: USE OF TSI MULTITEST MEDIUM FOR THE DIFFERENTIATION OF GRAM-NEGATIVE BACTERIA

Because of their complexity, multitest media can be used for testing several enzymatic activities simultaneously. Triple Sugar Iron (TSI) agar slant is generally used for the characterisation of Enterobacteria (**Table 2**). The medium is rich in protein and contains 0.1% glucose, 1.0% sucrose and lactose, ferrous sulphate and phenol red indicator (to support organisms able to degrade glucose, concentration of glucose is only 1/10 that of lactose and sucrose). Phenol red changes to yellow when the environment is acidic. The intestinal pathogens *Salmonella* and *Shigella*

ferment glucose but not sucrose or lactose. The most common Gram-negative, non-pathogenic faecal rods do not share these characteristics. TSI agar is slanted with a deep butt and should be inoculated with a special technique.

Table 2. Typical TSI reactions observed with some Enterobacteria

Taxon name	Stab inoculation	Slant surface inoculation	H ₂ S production	Gas production
<i>Enterobacter</i>	yellow	yellow	–	–
<i>Escherichia</i>	yellow	yellow	–	□
<i>Klebsiella</i>	yellow	yellow	–	–
<i>Proteus vulgaris</i>	yellow	yellow or red	+	–
<i>Serratia</i>	yellow	red or yellow	–	+/-
<i>Shigella</i>	yellow	red	–	–
<i>Salmonella typhi</i>	yellow	red	+	–

Object of study, test organisms:

unknown bacterial strain 24-hour slant culture

Materials and equipment:

TSI agar slants (see Appendix)
inoculating loop
Bunsen burner
incubator

Practise:

1. Inoculate the TSI agar slants with stab inoculation as well as a zigzag streak inoculation on the surface of the agar slant.
2. Incubate the tubes at 28°C for 2-7 days.
3. Evaluate the observed features of the agar as follows:

Yellow stab/butt inoculation and red slant → acid production from glucose degradation (because the fermentation of a small amount of glucose (0.1%) present in the medium happens only at the bottom, and the anaerobic zone becomes acidic)

Yellow stab/butt inoculation and yellow slant → acid production from lactose and/or sucrose degradation (because the fermentation of large amounts of sucrose and/or lactose (1%) happens, the whole nutrient medium becomes acidic and yellow)

Formation of **bubbles** or **cracks** → intensive fermentation, gas formation

Red stab inoculation and **red slant** → no carbohydrate degradation or gas formation

Black colouration → indicates H₂S production

7.4.3. Physiological and ecological studies on bacterial strains

Microbes easily adapt to natural habitats, however changes in the physicochemical properties in their environment (e.g. temperature, pH, light, partial pressure of oxygen, osmotic conditions) can strongly affect their life function (e.g. growth rate, pigmentation, endospore formation). Cells in the exponential phase of their growth are in general more sensitive, while cells in the stationary phase are more resistant to environmental effects.

EXERCISE 60: EFFECT OF TEMPERATURE ON MICROBIAL GROWTH

Temperature strongly influences the multiplication and metabolic processes of microbes. Characteristic values, such as: minimum, optimum and maximum, can be differentiated (cardinal temperatures). At optimum values, the speed of bacterial multiplication is at the maximum rate, the minimum and maximum values show the lowest and highest limits of their multiplication. Depending on where the optimum value is, bacteria can be differentiated as psychrophiles (e.g. *Bacillus psychrophilus*), mesophiles (e.g. *Staphylococcus aureus*, *Escherichia coli*), thermophiles (e.g. *Geobacillus stearothermophilus*, *Thermus aquaticus*) and hiperthermophiles (e.g. *Pyrodictium occultum*, *Pyrolobus fumarii*). Multiplication dynamics of microbes on different culture media can be studied under laboratory conditions.

Object of study, test organisms:

unknown bacterial strain slant culture

Materials and equipment:

nutrient slant agar medium (see Appendix)
sterile physiological saline solution
inoculating loop
Bunsen burner
incubator

Practise:

1. Prepare a suspension of the strain(s) of bacteria and inoculate a loopful onto fresh nutrient agar slants (see EXERCISE 27).
2. Incubate the test tubes at 4°C, 28°C and 37°C for one week.
3. Observe the intensity of of bacterial growth on the medium.

(See also Supplementary Figure S24.)

EXERCISE 61: TEMPERATURE TOLERANCE OF BACTERIA

The temperature tolerance of microbes can vary within species but even within strains of species. In general, Gram-negative organisms are more sensitive than Gram-positive cells and endospores are more resistant than the vegetative cells. Temperature tolerance depends on the applied temperature, length of treatment and other environmental parameters (pH, water activity, etc.).

Object of study, test organisms:

Escherichia coli suspension
Bacillus subtilis suspension

Materials and equipment:

20 mL nutrient agar medium (see Appendix) in large test tubes
60°C and 95°C water bath
pipette, sterile pipette tips
sterile Petri dishes
vortex mixer
Bunsen burner
incubator

Practise:

1. Place the melted sterile nutrient medium (prepared in large test tubes) into water baths of 60°C and 95°C.

2. Pipette 0.1-0.1 mL bacterial suspension aseptically into the test tubes, mix the liquid media with the suspension, incubate at the given temperature for 10 minutes, and then pour inoculated medium into sterile Petri dishes.
3. Incubate at 28°C for one week.
4. Observe the bacterial growth and estimate the temperature tolerance of each strain by counting the colonies formed in the agar plates.

(See also Supplementary Figure S22, S23.)

EXERCISE 62: EFFECT OF pH ON MICROBIAL GROWTH

In addition to temperature, hydrogen ion concentration has the greatest influence on microbial growth. The concentration of hydrogen ions, which is customarily designated by the term pH ($-\log[H^+]$), effects transport through the cell membrane and limits the activity of enzymes. As in the case of temperature, an optimum (concentration of hydrogen ions at which the bacterial growth is the most intensive) exists for each organism. Minimum and maximum hydrogen ion concentrations are pH values where an organism still shows growth. If the composition of the medium, incubation temperature or osmotic pressure is changed, the pH requirements may become different. Based on their pH optimum, microbes can be classified as acidophiles (e.g. *Sulfolobus acidocaldarius*, *Thiobacillus thiooxidans*), neutrophiles (e.g. *Escherichia coli*, *Micrococcus luteus*) and alkaliphiles (e.g. *Bacillus alcalophilus*).

Object of study, test organisms:

Escherichia coli suspension
Staphylococcus aureus suspension

Materials and equipment:

nutrient broth with different pH (pH 5, pH 7, pH 9) (see Appendix)
pipette, sterile pipette tips
vortex
Bunsen burner
incubator

Practise:

1. Label the test tubes.
2. Pipette 0.1-0.1 mL from the bacterial suspension into nutrient broths with pH 5, 7 and 9 under aseptic conditions and vortex them.
3. Incubate at 28°C for one week.
4. Estimate the pH tolerance of each strain by examining the intensity of bacterial growth (observe the turbidity of each broth and compare it with a control test tube that has not been inoculated with bacteria).

EXERCISE 63: EFFECT OF WATER ACTIVITY (A_w) ON MICROBIAL GROWTH

Microbes need free water molecules for their growth. Water activity (a_w) is a measure of unbound, free water to support biological and chemical reactions in a system. Therefore, water activity affects microorganisms' survival and reproduction. The water activity of a solution is quantitatively equal to the vapour pressure of the solution divided by the vapour pressure of pure water (both measured at the same temperature). Water molecules are loosely oriented in pure liquid water and can easily rearrange. When other substances (solutes) are added to water, water molecules orient themselves on the surface of the solute and the properties of the solution change dramatically. Microbial cells have to compete with solute molecules for free water molecules. A_w varies very little with temperature over the range of temperatures that support microbial growth. A_w varies between 0.00 and 1.00, a solution of pure water has an a_w of 1.00. The addition of a solute decreases the a_w to less than 1.00.

There is a threshold limit of water activity within which microbes can grow, but it differs among taxa (**Table 3**).

Table 3. The minimum water activity values tolerated by different microbes

Microbe group	a_w
Bacteria in general	0.91
Halophilic bacteria	0.75
Yeasts in general	0.88
Xerophilic yeasts	< 0.80
Moulds in general	0.80
Xerophilic moulds	0.70

There is a great importance of decreasing water activity e.g. in food industry. Conservation of different food products is often based on lowering the amount of accessible water for microbes (e.g. drying, salting, and freezing). Comparison of the osmotolerance of bacteria originating from diverse environments could be achieved by decreasing a_w in culture media with the addition of solutes, e.g. NaCl.

Object of study, test organisms

Escherichia coli suspension
Staphylococcus aureus suspension

Materials and equipment:

nutrient broth with different salt concentration (0%, 5%, 10% NaCl) (see Appendix)
 pipette, sterile pipette tips
 vortex mixer
 Bunsen burner
 incubator

Practise:

1. Label the test tubes.
2. Inoculate 0.1-0.1 mL bacterial suspension into culture broth with different salt concentrations (0%, 5%, 10%) under aseptic conditions and mix the solution.
3. Incubate at 28°C for one week.
4. Estimate the osmotolerance of each strain by examining the intensity of bacterial growth (observe the turbidity of each broth and compare it with a control test tube that has not been inoculated with bacteria).

EXERCISE 64: EFFECT OF UV RADIATION ON BACTERIAL GROWTH

Most microorganisms are sensitive to UV radiation. The UV range covers a wide band of the electromagnetic spectrum (4-400 nm), but only a narrow range of this spectrum has germicidal effect. Very strong bactericidal effect exists at a wavelength of 265 nm, due to the damage to the DNA. Usually the pigmented and the endospore-forming bacteria are the most resistant to the effects of ultraviolet radiation.

Object of study, test organisms:

Escherichia coli suspension
 unknown bacterial strain suspension

Materials and equipment:

nutrient agar plates (see Appendix)
 sterile distilled water (9 mL)
 pipette, sterile pipette tips
 glass spreader (alcohol for sterilisation)
 vortex mixer
 Bunsen burner

UV lamp
scissors
foil or cardboard
incubator

Practise:

1. Spread 0.1 mL from the bacterial suspension onto the agar plates.
2. Cut out a selected form from foil or cardboard, remove the upper part of the Petri dish and place the form above the agar surface (without touching the surface of the medium).
3. Expose infected agar plates to UV radiation for different time intervals (10-20-30 minutes).
4. Take the form off the agar plate and close the Petri dish.
5. Incubate at 28°C for one week.
6. Evaluate the germicidal effect based on the intensity of bacterial growth (density of colonies on the agar surface).

7.4.4. Study of the effect of antimicrobial compounds and antibiotics

Antimicrobial drugs are chemicals that negatively affect the growth of microbes: they include antibiotics (a group of compounds originally produced by bacteria and fungi that hamper the activity of other microbes even at low concentration). Some drugs are bacteriostatic (inhibition of growth is reversed when the drug is removed), others are bactericidal (exerting an irreversible lethal effect). The distinction between bactericidal and bacteriostatic action is however not absolute, since some normally bactericidal agents appear to be bacteriostatic at relatively low concentrations.

The mode of action of antimicrobial drugs can be different: denaturation of proteins, injury to the cell wall or cytoplasmic membranes or inhibition of certain metabolic processes.

EXERCISE 65: DETERMINATION OF THE LYSOZYME CONTENT OF EGG WHITE

Lysozyme is a glycoside hydrolase enzyme responsible for the digestion of murein of bacteria and is produced by several organisms and microbes (plant and animal tissues, bacteria, bacteriophages). Lysozyme can be found also in the albumin of the egg white. Activity of this enzyme can be tested by the decrease of the optical density of a *Micrococcus luteus* suspension.

Object of study, test organisms:

Micrococcus luteus culture on Petri plate

Materials and equipment:

egg
phosphate buffer (see Appendix)
lysozyme
sterile flask
sterile small test tubes
pipettes, sterile pipette tips
inoculating loop
vortex mixer
Bunsen burner
incubator
spectrophotometer with 10 mm cuvettes

Practise:

1. Make a suspension from *M. luteus* (24-hour culture) in 5 mL phosphate buffer.
2. Break the egg and separate the egg white into a sterile flask.
3. Dilute the egg white 1000x with phosphate buffer.
4. Prepare a 4 µg/mL lysozyme standard solution.
5. Make a suspensions containing 1.5-100% sample (egg white or lysozyme solution) in small test tubes (see Appendix).
6. Pipette 0.3-0.3 mL *M. luteus* suspension to the dilution series in 1 minute intervals and vortex the tubes.
7. Incubate at room temperature for 30 minutes.
8. Determine the optical density of solutions at 520 nm wavelength with a spectrophotometer.
9. Make a standard curve as a function of logarithm (\log_{10}) of lysozyme concentration against the measured OD values (on a semi-logarithmic paper or using a PC). Determine the lysozyme concentration of the egg white using extrapolation from the standard curve.

Antibiotics were originally defined by Waksman (1945) as “chemical substances“ produced by microorganisms, which possess the ability to kill or inhibit the growth of bacteria and other microorganisms at remarkably low concentrations. Most of these compounds act by inhibiting the formation of a particular type of macromolecule in the microbial cell. For example, penicillins and cephalosporins inhibit peptidoglycan synthesis; streptomycin, chloramphenicol and the tetracyclines interfere with protein biosynthesis; rifampicin and actinomycin D prevent nucleic acid synthesis; polymyxin B, valinomycin and gramicidin A inhibit cell membrane function. The range of microbes affected by an antimicrobial agent is its spectrum; antibiotics are either broad-spectrum or narrow-spectrum antimicrobials.

Most antibiotics are produced by bacteria (genera *Streptomyces* and *Bacillus*) and the fungal genus *Penicillium*. Some of those are chemotherapeutic agents - they may be defined as chemicals that can be applied in therapeutics, since at concentrations tolerated by the host, they can interfere directly with the proliferation of a given microorganism (i.e. have selective toxicity).

The effects of different antibiotics are given in (Table 4).

Table 4. The effect of different antimicrobial drugs

Name	Effect	Type (spectrum)
Antibiotic		
Penicillin G	blocking cell wall biosynthesis	narrow, Gram ⁺
Ampicillin/ Sulbactam	blocking cell wall biosynthesis	broad, Gram ⁺ , some Gram ⁻
Vancomycin	blocking cell wall biosynthesis	narrow, Gram ⁺
Streptomycin	blocking protein biosynthesis (30S ribosome)	broad, Gram ⁺ , Gram ⁻
Tetracyclin	blocking protein biosynthesis (30S ribosome)	broad, Gram ⁺ , Gram ⁻ <i>Rickettsia</i> , <i>Chlamydia</i>
Chloramphenicol	blocking protein biosynthesis (50S ribosome)	broad, Gram ⁺ , Gram ⁻ <i>Rickettsia</i> , <i>Chlamydia</i>
Erythromycin	blocking protein biosynthesis (50S ribosome)	narrow, Gram ⁺ , Mycoplasma
Ciprofloxacin	blocking DNA biosynthesis	narrow, Gram ⁺ , Gram ⁻
Rifampicin	blocking DNA biosynthesis	broad, Gram ⁺ , Mycoplasma
Polymyxin B	blocking membrane transport processes	narrow, Gram ⁻

Name	Effect	Type (spectrum)
Chemotherapeutic drug		
Sulphamethoxazol/ Tri- metoprim	blocking tetrahydrofolate synthesis	<i>broad, Gram⁺, Gram⁻</i>

EXERCISE 66: STUDING THE EFFECT OF ANTIBIOTICS USING THE KIRBY-BAUER METHOD

In this method, a culture is spread on an appropriate medium. Filter paper discs containing a pre-determined concentration of an antimicrobial are placed onto the infected agar plate, with equal spacing between discs (generally 3-5 discs / Petri dish). During incubation, the agent diffuses from the disc, creating a concentration gradient that decreases with the distance from the discs. After incubation, sensitivity is measured on the basis of the size of the inhibition zone (with no microbial growth) around each disc (Fig. 34). These measured values are compared to values of a standard scale, which indicates whether the microorganism is resistant, intermediate or sensitive to the antibiotic. Sensitive means that the organism is inhibited by a clinically attained concentration of the antimicrobial; resistant means that the organisms is not inhibited; intermediate means that special considerations are to be followed if the antibiotic is to be used.

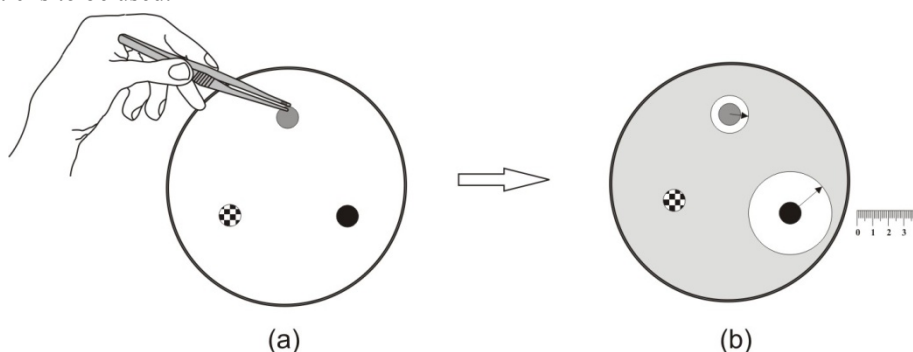

Fig. 34. Investigation of the effect of antibiotics with the Kirby-Bauer method. (a) Spread suspension from the examined bacterial strain onto agar plates and place antibiotic-containing discs onto the inoculated plate (3-5 discs onto each plate). (b) After the incubation time, antibiotic sensitivity is measured on the basis of the size of the zone of inhibition (no growth) around each disc.

Object of study, test organisms:

unknown bacterial strain

Materials and equipment:

sterile distilled water
inoculating loop
vortex mixer
nutrient plate (see Appendix)
pipettes, sterile pipette tips
glass spreader (alcohol for sterilisation)
forceps
antibiotic discs
Bunsen burner
incubator
ruler

Practise:

1. Prepare a suspension from the unknown bacterial strain in sterile distilled water.
2. Spread 0.1 mL from the suspension onto nutrient agar plates and label the Petri dishes.
3. Place antibiotic discs with sterilised forceps onto the medium surface (3-5 discs onto each plate).

4. Incubate at 28°C for one week.
5. Check the presence of inhibition zones and measure their diameter.

EXERCISE 67: *IN VITRO* SYNERGISM OR ANTAGONISM OF DIFFERENT ANTIBIOTICS

The addition of two or more antimicrobial agents to a microbial population sensitive to each of the individual compounds may have various outcomes. The overall inhibitory effect may be similar to the sum of the individual agents (indifference), it may show enhancement (synergy), or it may be considerably lower (antagonism) (Fig. 35). The effect could be tested by placing discs overlapping each other and containing different antimicrobial agents onto infected agar plates, and examining the inhibition zones surrounding the intersection after incubation.

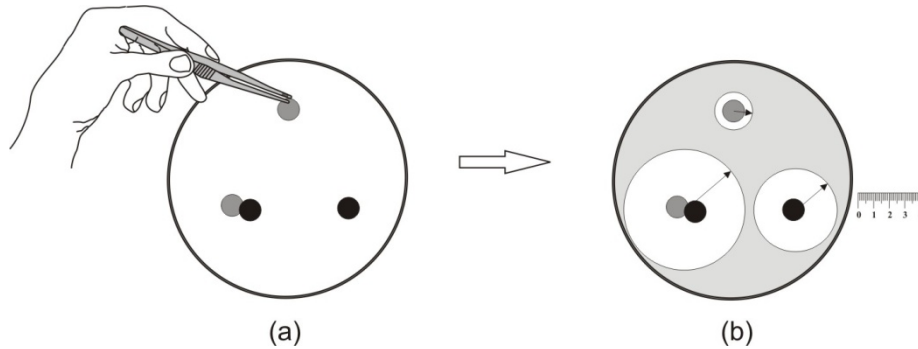

Fig. 35. Study of the *in vitro* synergism or antagonism of different antibiotics. (a) Spread suspension from the examined bacterial strain onto agar plates and place two antibiotic discs onto the inoculated plate “in pair” (so that the two discs overlap) and separately. (b) After the incubation time, antibiotic sensitivity is measured on the basis of the size of the zone of inhibition (no growth) around each disc.

Object of study, test organisms:

unknown bacterial strain

Materials and equipment:

sterile distilled water
 inoculating loop
 vortex mixer
 nutrient plate (see Appendix)
 pipette, sterile pipette tips
 glass spreader (alcohol for sterilisation)
 forceps
 antibiotic discs
 Bunsen burner
 incubator
 ruler

Practise:

1. Prepare infected plates as in EXERCISE 66.
2. Place antibiotic discs in pairs (such that the two discs overlap) with sterilised forceps onto the medium surface (Fig. 35). Use the same discs separately, too.
3. Incubate at 28°C for one week.
4. Check the inhibition zones and measure their diameter. Determine the combined effect of antibiotics.

EXERCISE 68: SCREENING THE ANTIMICROBIAL EFFECT OF THE CULTURE FILTRATE OF A *STREPTOMYCES* STRAIN

Microorganisms produce several primary and secondary metabolites. Some of them have antimicrobial activity, which can be tested with agar diffusion assay.

Object of study, test organisms:

Staphylococcus aureus slant culture
Streptomyces sp. slant culture

Materials and equipment:

malt extract broth in flask (see Appendix)
nutrient broth (see Appendix)
inoculating loop
shaker bath (37°C)
spectrophotometer
nutrient plate (see Appendix)
pipettes, sterile pipette tips
0.45 µm pore size membrane filter
filtration equipment
glass spreader (alcohol for sterilisation)
forceps
paper discs
6 mm cork borer
Bunsen burner
incubator

Practise:

1. Inoculate the malt extract broth with the *Streptomyces* strain and incubate it with shaking at 37°C for one week.
2. Inoculate the test organism *S. aureus* into nutrient broth one day before *Streptomyces* strain incubation is finished.
3. Set the OD (at 660 nm) of test organism with spectrophotometer to 0.3.
4. Inoculate 100 mL melted, 50°C nutrient agar with 1 mL suspension from the test organism, and then pour plates (approximately 4-5) and let them solidify.
5. Filter the *Streptomyces* culture into a sterile flask through a membrane filter. (Optionally centrifugation could be performed to remove the bulk of cells prior to filtration.)
6. Make a hole in the inoculated plates with a cork borer and pipette the filtrate of the *Streptomyces* culture into the holes. In parallel, rinse filter paper discs into the sterile filtrate of the *Streptomyces* strain, and then place them onto the inoculated Petri plates.
7. Measure the inhibition zones after 24 hours, and after one week of incubation at 37°C.

EXERCISE 69: DETECTION OF ANTAGONISM BETWEEN MICROBES USING CROSS-STREAK EXPERIMENTS

The detection of antagonism in cross-streak experiments is also possible (Fig. 36).

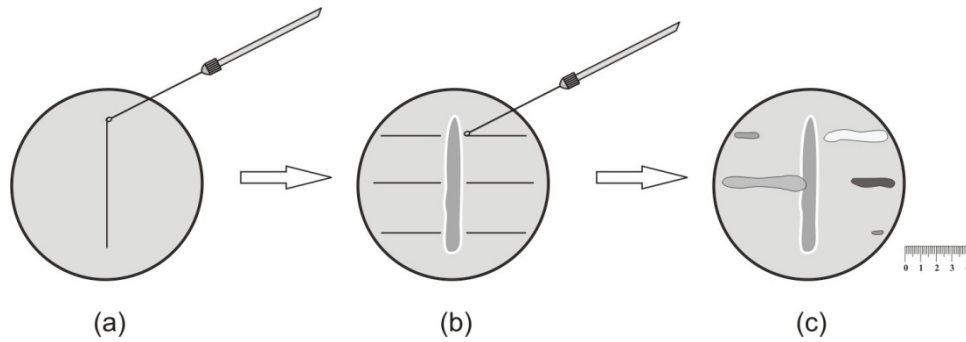

Fig. 36. Detection of antagonism in cross-streak experiments. (a) Line-inoculation of the antibiotic-producer strain onto the nutrient Petri plate. (b) Inoculation of the test organisms with cross-streak method just near the producer microorganism. (c) Measurement of the inhibition distance after the incubation period.

Object of study, test organisms:

Penicillium chrysogenum (antibiotic producer strain)
Escherichia coli slant culture
Bacillus cereus slant culture
Micrococcus luteus slant culture
Serratia marcescens slant culture
Staphylococcus aureus slant culture
 unknown bacterial strain slant culture

Materials and equipment:

nutrient plate (see Appendix)
 inoculating loop
 Bunsen burner
 incubator

Practise:

1. Inoculate the antibiotic-producer strain onto the centre of a nutrient plate with line-inoculation (Fig. 36).
2. Incubate at 28°C for one week.
3. Inoculate the test organisms with the cross-streak method near the antibiotic-producer microorganism (do not touch the *Penicillium* colony at inoculation!).
4. Incubate at 28°C for one week.
5. The antimicrobial effect can be determined by measuring the inhibition distance.

EXERCISE 70: APPLICATION OF REPLICA-TECHNIQUE FOR THE ISOLATION OF ANTIBIOTIC-SENSITIVE OR -RESISTANT MICROBES

Bacteria can acquire resistance to antibiotics by several ways (e.g. by horizontal gene transfer). With the so-called “replica-technique”, the isolation of antibiotic resistant microorganisms can be relatively easily performed (Fig. 37). “Copies” from discrete bacterial colonies that grew on the surface of a Petri plate are prepared with this method. A velvet fabric is stretched onto a wooden, plastic or metal log. The Petri-dish is then carefully pressed against the surface of the velvet. Fine filaments of the velvet function as inoculating loops/needles so that we are able to transfer all the colonies from the agar plate onto new, sterile agar plates in just one step. Using selective media (e.g. containing a specific antibiotic), based on the absence or presence of the colonies present on the original plates, metabolic mutants, microbes with distinct properties can be retrieved.

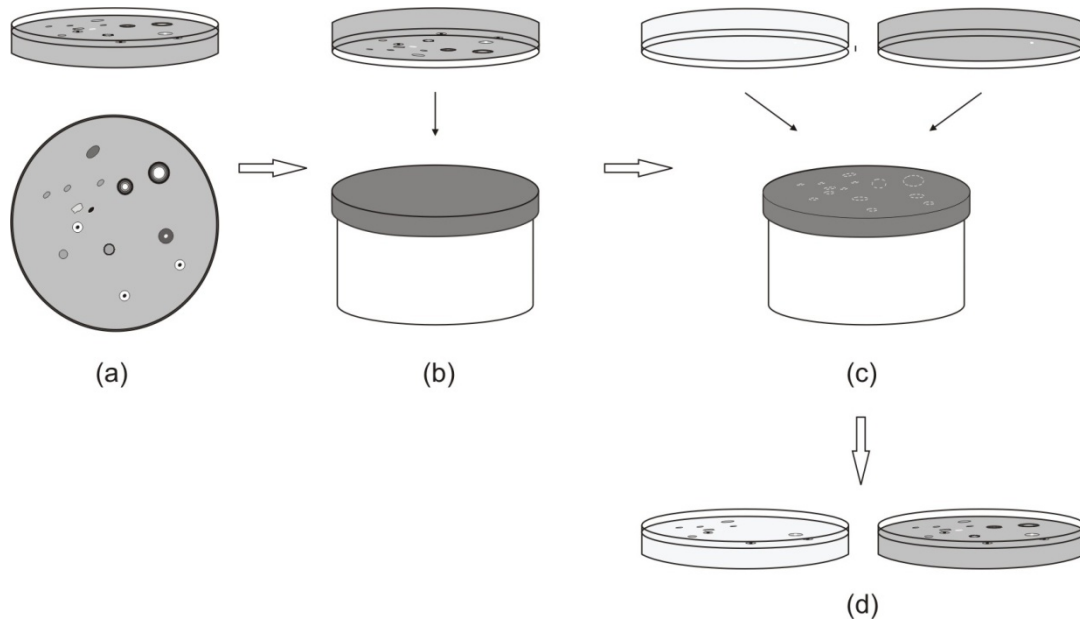

Fig. 37. Application of the replica-technique. (a) Use previously spread nutrient plate cultures originating from any environmental sample. (b) Make a copy of it with the help of sterile velvet stretched on a replica log. (c) Make copies onto different antibiotic-containing agar plates. (d) After incubation, compare the original and the replicate plates and decide the antibiotic resistance of colonies.

Object of study, test organisms:

previously spread nutrient plates from environmental samples (soil, water, etc.)

Materials and equipment:

sterile velvet on a replica log
 agar plates containing different antibiotics
 incubator

Practise:

1. Press the velvet slightly onto the surface of a nutrient plate with discrete bacterial colonies.
2. Make copies onto different antibiotic containing agar plates. Take care to use the same position for replicating as the original one (mark it carefully!).
3. Incubate at 28°C for one week.
4. Compare the original and the replica plates and identify the colonies that have antibiotic resistance or sensitivity.

EXERCISE 71: STUDYING THE ANTIMICROBIAL COMPOUNDS PRODUCED BY PLANTS

Many vascular plants produce chemical compounds that inhibit the growth of microorganisms (phytoncides) and this may play an important role in their resistance to pathogens. Different plants produce different compounds, which vary in their antimicrobial action, and microorganisms also differ in their sensitivity to these compounds. Garlic is a good example of such plants that contain antimicrobial compounds. The technique used to test the anti-bacterial effect is simple: place slices of garlic onto infected agar plates and examine the areas of growth inhibition surrounding the slices after incubation.

Object of study, test organisms:

unknown bacterial strain slant culture

Materials and equipment:

flasks
hot water bath
nutrient plate (see Appendix)
pipette, sterile pipette tips
glass spreader (alcohol for sterilisation)
vortex mixer
forceps
6 mm cork borer
knife or scalpel
plants and plant extracts (onion, garlic, ginseng root, camomile, ginger, horseradish, thyme, etc.)
Bunsen burner
incubator

Practise:

1. Extract the plant compounds in hot water bath for 10 minutes or use the already prepared extracts.
2. Make a suspension from the unknown bacterial strain in sterile distilled water.
3. Spread 0.1-0.1 mL of the suspension onto nutrient plates, and then make three holes into it with a sterilised cork borer. Fill the holes with the plant extract.
4. In parallel, cut slices from garlic, onion, ginseng roots etc. with a sterile scalpel and place them onto the surface of the inoculated Petri plates (with cutaway surface facing the medium).
5. Incubate the Petri dishes at 28°C for one week.
6. Check and measure the inhibition zones around the different plant compounds and slices and evaluate your data.

EXERCISE 72: EFFECT OF HEAVY METAL IONS ON BACTERIA

Heavy metal ions (Ag^+ , Cu^{2+} , Ni^{2+} , etc) are toxic for microorganisms already at low concentrations (denaturation of proteins). To test their effect on bacteria, ions of the given heavy metal are diffused into the medium that generate inhibition zones.

Object of study, test organisms:

unknown bacterial strain slant culture

Materials and equipment:

sterile distilled water
nutrient plate (see Appendix)
pipette, sterile pipette tips
glass spreader (alcohol for sterilisation)
vortex mixer
forceps
6 mm cork borer
saturated CuSO_4 solution
small copper sheet
coins
Bunsen burner
incubator

Practise:

1. Make a suspension from the unknown bacterial strain in sterile distilled water.

2. Spread 0.1-0.1 mL of the suspension onto nutrient plates, and then make 3 holes into it with a sterilised cork borer. Fill the holes with CuSO₄ solution.
3. In parallel, place previously heat-sterilised copper sheets and coins, onto the agar surface.
4. Incubate the Petri dishes at 28°C for one week.
5. Check and measure the inhibition zones and evaluate your data.

(See also Suppl Figure S26, S27.)

7.4.5. Chemotaxonomical studies of bacterial strains

Chemotaxonomy deals with the chemical variability present in living organisms. Its methods developed together with chromatographic techniques. With chemotaxonomical methods, it is possible to study the taxonomically relevant features of nucleic acids and proteins, characteristic carbohydrates, and the lipid components of microbes as well.

With the spread of the nucleic acid-based techniques, chemotaxonomical methods are overshadowed but these methods still have a significance at species descriptions. In addition, chemotaxonomical methods are also widely used for studying the microbial diversity of various habitats. In contrast to PCR-based methods, they give more reliable quantitative data as no amplification of the components is required. The main chemotaxonomical biomarkers are listed in **Table 5**.

Table 5. Chemotaxonomical biomarkers in the cell wall and cytoplasmic membrane of bacteria

Cell structure and cell type	Chemotaxonomical biomarker
cytoplasmic membrane	isoprenoid quinones lipid soluble pigments lipoteichoic acids polar lipids proteins
cell wall	peptidoglycan and derivatives polysaccharide components teichoic acids and derivatives
outer membrane of Gram-negative cells	lipopolysaccharides (K and O antigens) polar lipids
Gram-positive cells	bound lipids: mycolic acids free lipids: glycolipids, sulphoglycolipids, waxes

EXERCISE 73: DETERMINATION OF DAP CONTENT OF BACTERIAL CELLS

The type of peptidoglycan is a very important character of bacterial cell walls. The glycan part is relatively uniform, in some cases minor variability occurs: N-acetyl muramic acid is replaced by N-glycolyl muramic acids (e.g. in some Actinobacteria). The most important and variable characteristic is the composition of connecting oligopeptides and the structure of interpeptide bridges within the murein layer.

The cell wall diamino-pimelic acid (DAP) content can be studied with the use of whole-cell lysates as DAP can only originate from the bacterial cell wall. Thin layer chromatography (TLC) is used to investigate the DAP content of heat-treated purified biomass.

Object of study, test organisms:

Escherichia coli slant culture
Brevibacterium linens slant culture
Nocardioides hungaricus slant culture
unknown bacterial strain slant culture

Materials and equipment:

4 mL glass test tubes with Teflon-lined screw cap
block thermostat
6M HCl solution
laboratory oven
activated carbon
pipette, pipette tips, filter paper
cellulose TLC
microcapillary
glass developing tank for running TLC
solvents (methanol, distilled water, 6M HCl solution, pyridine)
DAP standard solution (see Appendix)
ninhydrin reagent (see Appendix)

Practise:

1. Place 2-3 loopfuls of bacterial culture into the glass tubes containing 300 μ L 6M HCl solution, and close with the Teflon-lined screw caps.
2. For the destruction of cells (and cell walls), incubate at 121 °C for 20 min in a block thermostat (partial destruction is possible with 4N HCl solution).
3. Evaporate the remaining HCl at 70°C in a laboratory oven and add 100-150 μ L distilled water.
4. As this lysate still contains cell debris, purification is necessary: prepare a filter from a 1 mL pipette tip (using filter paper and activated carbon) and then filter the lysate through this filter tip.
5. Prepare the TLC plate by marking the starting line with a soft pencil, and spot the plate with 8 μ L lysate using a microcapillary and hairdryer to get as small spots as possible. Use 1% DAP standard solution as a positive control.
6. Run TLC plates (using methanol-distilled water: 6N HCl: pyridine in 80:26:4:10 ratio as solvent mixture) for 2-2.5 hours at 4-10°C.
7. For the visualisation of the chromatogram, spray it with ninhydrin reagent, and put the plates into oven at 100°C for 5 minutes. DAP forms greyish-coloured spots.
8. Evaluate your results, compare the DAP content of different bacterial strains.

EXERCISE 74: DETERMINATION OF ISOPRENOID QUINONE COMPOSITION OF BACTERIAL CELLS

Isoprenoid quinones are mobile proton and electron carriers of electron transport chains located in the cytoplasmic membrane. Based on their chemical structures, these molecules are divided into naphthoquinones and benzoquinones. Naphthoquinones are made up of phyloquinones and menaquinones, while benzoquinones include plastoquinones and ubiquinones. Analysis of isoprenoid quinones of bacteria can demonstrate the differences among higher taxa (family, order, and genus).

Ubiquinones are widespread in nature (plants, animals and microorganisms). The variability within this quinone type is low, differences occur mainly in the number of isoprenoid units in the side chain. Menaquinones are restricted to prokaryotes and could be found both in Bacteria and Archaea. Variability of menaquinones occurs in the length as well as the saturation of the isoprenoid side chain. Occasionally the side chain can form a ring structure in some genera.

Object of study, test organisms:

Escherichia coli lyophilised culture
Brevibacterium linens lyophilised culture
Nocardioides hungaricus lyophilised culture
Pseudomonas fragi lyophilised culture
Arthrobacter variabilis lyophilised culture
unknown bacterial strain lyophilised culture

Materials and equipment:

solvents (methanol, chloroform, hexane, diethyl ether, acetonitrile, isopropanol)
glass flask/tube
filter paper
magnetic stirrer
Silicagel 60 F₂₅₄ TLC plate
microcapillary
glass developing tank for running TLC
solvents hexane, diethyl ether
rotary evaporator
K₂ vitamin standard solution (menaquinone MK7)
ubiquinone Q10 standard solution
microcentrifuge
microcentrifuge tubes with filters
pipettes, pipette tips
HPLC equipment
UV lamp

Practise:

1. Measure 300 mg lyophilised bacterial biomass into a glass flask containing chloroform:methanol (2:1) solvent mixture. Stir overnight with a magnetic stirrer at 4°C.
2. Filter the mixture through filter paper to remove cell debris.
3. Evaporate the extract in a rotary evaporator, then collect the residue in 1 mL chloroform:methanol (2:1) solution.
4. Purify the samples with thin layer chromatography using Silicagel 60 F₂₅₄ TLC plates and hexane:diethyl ether (55:10) solvent using K₂ vitamin solution as standard. This way, quinones are separated from all other extracted organic materials (other lipids, pigments, etc.), and ubiquinones are also separated from menaquinones. The average retention factor (R_f) of menaquinones is 0.8, while that of ubiquinones is 0.3. Place the TLC plates under a UV lamp (254 nm). Quinones appear as greyish spots/lines on the plates.
5. Precise determination of quinone molecules is not possible with TLC. Scrape off the quinone band and dissolve in an acetonitrile:isopropanol (65:35) solvent mixture (overnight incubation at 4°C).
6. Filter the silica debris using microcentrifuge tubes containing filters (spin at 3000 g for 3 min). This filtrate can be directly injected to HPLC column (ODS Spherisorb, 250 mm x 4.6 mm id., eluent: acetonitrile:isopropanol 65:35, flow rate: 1.300 mL/min, pressure of column: 88 bar, temperature: 30°C, detection at 270 nm).
7. Use the chromatograms of other authentic strains and standard Q10 solution for data evaluation. There is a linear correlation between the logarithm of retention times and the number of isoprenoid units in the quinone side chain. This helps to identify the peaks on the chromatograms.

8. Evaluate your data on a semi-logarithmic paper (or with use excel program of a PC) and compare the quinone profiles of the different bacterial strains.

EXERCISE 75: DETERMINATION OF FATTY ACID PROFILE OF BACTERIA

Fatty acids present in bacteria (Fig. 38) are molecules with 14-20 carbon atoms and are relatively simple in their structure. The most frequent ones are straight chain unsaturated or partially saturated molecules. The length of the carbon chain and the degree of saturation can be characteristic of a given taxon.

Analysis of fatty acids contains four steps: saponification (liberation of fatty acids from fats and oils), esterification of fatty acids (to form fatty acid methyl esters), extraction (of fatty acid methyl esters with solvents) and purification of the extract (washing step).

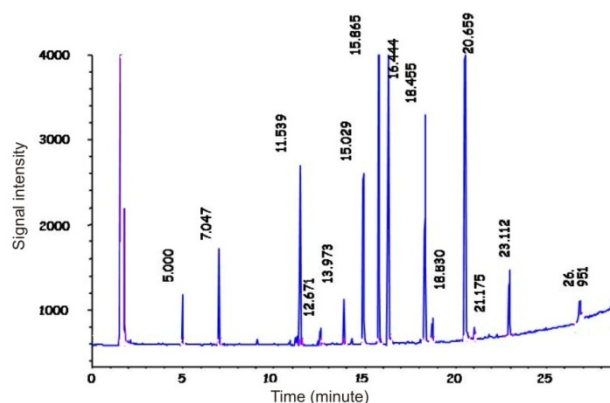

Fig. 38. Fatty acid methyl ester profile of a bacterial strain. The profile was prepared with gas chromatograph (GC). Peaks were identified on the basis of their retention time using BAME (bacterial methyl ester) standard.

Object of study, test organisms:

Log-phase cultures (usually 24 hours) grown on TSA medium at 28°C of the following bacteria:

Escherichia coli
Brevibacterium linens
Nocardioides hungaricus
Pseudomonas fragi
Arthrobacter variabilis
 unknown bacterial strain

Materials and equipment:

TSA plates (see Appendix)
 10 mL glass test tubes with Teflon-lined screw caps
 Reagent 1, 2, 3 and 4 (see Appendix)
 vortex mixer
 overhead mixer
 degreased glass tubes
 water bath
 slush ice
 degreased Pasteur pipettes
 1 mL glass tubes for sample storage
 microlitre syringe
 gas chromatograph (GC)
 BAME (Bacterial Methyl Ester) standard solution

Practise:

1. Add 1 mL Reagent 1 to 2-3 loopfuls of bacteria in glass tubes, close with Teflon-lined screw caps, vortex and incubate in 100°C water bath for 5 minutes (saponification).
2. Vortex again and put the tubes back to the 100°C water bath, then cool them down suddenly in slush ice.
3. Add 2 mL Reagent 2, vortex and incubate in 80°C water bath for 10 minutes, then cool them suddenly in slush ice.
4. After this methylation process, add 1.25 mL Reagent 3 and mix with overhead mixer for 10 minutes.
5. Discard the lower phase using Pasteur pipette and add 3 mL Reagent 4 to the upper, "solvent" phase, mix for 5 minutes. 1 µL of this liquid can be directly injected into a gas chromatograph.
6. Conditions of GC analysis: splitless injection, capillary column (SPB-1, 30x32 mm id.), heating condition: 150-250°C, heating rate: 4°C/min, carrier gas: Helium, detector: FID, 280°C.
7. Storage of these fatty acid samples is possible in 1 mL test tubes at -20°C for a few weeks.
8. Evaluate the obtained data with the help of BAME (Bacterial Methyl Ester) standard and compare the results of different bacteria.

EXERCISE 76: DETERMINATION OF VOLATILE FERMENTATION END PRODUCTS OF BACTERIAL CULTURES AND FOOD SAMPLES

Short chain (C1-6) fatty acids are the intermediates or end-products of fermentations. In basic research, fermentation pathways can be mapped with the study of these molecules. Such analyses have importance in the food industry.

Analysis of fermentation end products supports the classification of anaerobic microorganisms. The different types of fermentations are characteristic of a given taxon.

Object of study, test organisms:

cultures of anaerobic bacteria in thioglycollate medium
various cheeses and other dairy products

Materials and equipment:

thioglycollate medium (see Appendix)
microcentrifuge
microcentrifuge tubes
vortex mixer
freezer
50% H₂SO₄ solution
methyl-t-butyl-ether (MTBE) solution
CaCl₂
microlitre syringe
standard solution (**Table 6**)
gas chromatograph (GC)

Practise:

1. Pipette 0.5 mL bacterial suspension (from thioglycollate broth) or 1-2 g homogenised cheese/yoghurt into a microcentrifuge tube, and then add 0.05 mL 50% H₂SO₄ and 0.5 mL methyl-t-butyl-ether solution.
2. Vortex for 5-10 sec, then centrifuge to break the emulsion.
3. Transfer the upper phase (ether-phase) to a clean microcentrifuge tube, then put it into the freezer (-20°C) to freeze the remaining water.
4. Rapidly transfer the liquid phase to a clean microcentrifuge tube and put CaCl₂ crystals into the tube to extract residual water.

5. Inject 1 μL to GC from each sample and also from the control solution and determine the volatile acid-composition (see parameters of chromatography in **Table 6**).
6. Evaluate your data and compare the end products of bacteria and food products.

Table 6. Parameters of gas chromatography at determination of volatile fermentation end products of bacteria and food samples.

Chromatography		Standard (in 100 mL distilled water)	
Column type	19001c-003	formic acid (50%)	0.114 mL
	6 ft 10% FFAP 1% H_3PO_4	acetic acid (96%)	0.037 mL
		propionic acid	0.075 mL
Detector type	FID (Flame ionisation detector)	isobutyric acid	0.092 mL
Column temp.	145°C	butyric acid	0.091 mL
Injector temp.	180°C	valeric acid	0.109 mL
Detector temp.	190°C	isovaleric acid	0.109 mL

7.4.6. Bacterial species identification based on 16S rDNA sequence homology

One of the most unambiguous methods of the identification of bacterial strains on the species level is the 16S rRNA gene (16S rDNA) sequence analysis. The major steps of this method are: DNA extraction, amplification of 16S rRNA gene with consensus PCR, determination of the amplicon's nucleotide sequence (sequencing) and sequence comparisons using publicly available databases.

EXERCISE 77: DNA EXTRACTION FROM BACTERIAL STRAINS

The procedure of DNA extraction can be divided into two main parts. The first step covers cell disruption, while in the second part, DNA is purified from other molecules and cell debris.

Disruption of cells can be achieved by chemical, enzymatic or physical methods or with the combination of these. Physical cell disruption can be performed e.g. with a blade homogeniser (which homogenises samples with small rotating knives), mixer mill (which shakes the cells together with glass beads), or grinding cells in liquid nitrogen using a mortar. Disruption of cells with incubation at high temperature (e.g. 98°C for 5 minutes) is also possible. A combined chemical/enzymatic method utilises the effect of detergents (e.g. SDS) with proteases, in the case of Gram-positive bacteria, lysozyme, or in the case of yeasts, lyticase.

Several techniques are available for DNA purification. One of the easiest ways is desalting, when, following a quick spinning to get free from cell debris, DNA, proteins and other molecules are precipitated under high salt concentration. The precipitate is dissolved in water and then DNA is recovered with ethanol precipitation. The efficiency of this method is variable.

Extraction with organic solvents is performed with the addition of phenol, chloroform, isoamyl alcohol or their mixture to cell lysate in a ratio of 1:1, which is followed by centrifugation, and the recovery of DNA is performed again with ethanol precipitation. This method is very effective for DNA extraction and also for the elimination of organic cell components and contaminants, but its drawbacks are that the procedure is time-consuming, cannot be automated and hazardous waste is produced.

In the case of CsCl gradient centrifugation, cell lysate is precipitated with ethanol, which is followed by centrifugation through a CsCl gradient using ethidium bromide staining, and subsequently the appropriate DNA-containing layer is separated. DNA can be purified from ethidium bromide with isopropanol, and finally ethanol precipitation is applied again. This method yields very pure DNA as a result, which is protected from fragmentation. On the

other hand, the procedure is time-consuming, moreover expertise and special equipment are required, and here, too, hazardous waste is produced.

Anion exchange methods are based on solid phase anion chromatography. At low salt concentration, the negatively charged phosphate-containing part of the DNA molecule can bind to a positive substrate. At medium salt concentration, RNA, proteins and metabolites can be washed from the substrate, while at high salt concentration, DNA can be eluted. Finally, DNA is recovered with ethanol precipitation. The method yields long (150 kbp) and very pure DNA.

Silicate-based methods exploit the selective binding of DNA to a silicate gel at high concentration of chaotropic salts (e.g. sodium persulphate, lithium chloride; the solution is usually termed as “binding buffer”). The next step is the washing-away of RNA, small DNA fragments and salts, and finally the elution of DNA at low salt concentration (e.g. with water). This method is quick and does not require ethanol precipitation, furthermore ethanol precipitation can also be replaced by this DNA purification technique. The silicate-based methods yield pure DNA, free from small fragments, but the method is not suitable for the purification of very large DNA molecules. Silicate-based DNA purification steps are widespread in commercial DNA isolation kits, in which all necessary materials and solutions for the process are available.

The most important requirement of DNA extraction is the production of proper-quality DNA. Low quality DNA extracts contain other cell components (e.g. proteins, RNA) or contaminants that were introduced to the sample during the extraction process (e.g. salts, phenols, ethanol or detergents). All these substances can hinder subsequent applications. DNA purity can be checked by spectrophotometric analysis, and described with the quotient of absorption measured at 260 and 280 nm. This value is 1.6-1.8 in the case of DNA of high purity.

Different DNA characterisation methods need different DNA quantities. In the case of the most frequently used PCR-based techniques, the following considerations are useful: The quantity of sample used for DNA extraction depends on the DNA content of individual cells. Recommended cell numbers used for DNA isolation are for bacteria: 10^9 , for yeasts: 10^7 , and for animal cell cultures: 10^6 cells.

The result of DNA extraction (purity and size) can be checked with agarose gel electrophoresis. To avoid degradation, DNA should be kept in a freezer (at -20°C).

Object of study, test organisms:

bacterial slant cultures

Materials and equipment:

inoculating loop
micropipettes, sterile pipette tips
microcentrifuge tubes
microcentrifuge tube rack
microcentrifuge
vortex mixer
0.5 M NaOH solution
TRIS [tris(hydroxymethyl)aminomethane] buffer (pH 8.0) (see Appendix)
mixer mill (bead beater)
thermocycler or water bath
dH₂O [DEPC(diethyl pyrocarbonate)-treated distilled water]
sterile glass beads
DNA isolation kit
laboratory scales
measuring cylinder
250 mL flask
electrophoresis system
agarose
10×TBE solution (see Appendix)
DNA stain
loading buffer (see Appendix)

DNA ladder (e.g. Lambda DNA *EcoRI/HindIII*, Marker 3, Fig. 39)

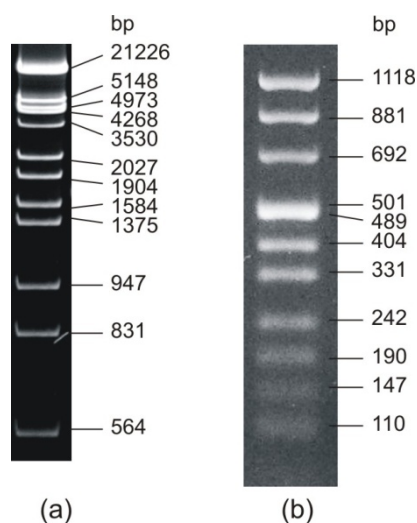

Fig. 39. DNA markers. (a) DNA ladder, Marker 3 in 6% polyacrylamide gel (b) DNA ladder, Marker 8 in 2% agarose gel.

Practise:

1. Three DNA isolation procedures are performed in parallel, that differ in the cell lysis step: chemical (steps 2-3.), physical (steps 5-8.) and the combination of chemical, physical and enzymatic lysis methods using a commercial DNA isolation kit (step 9).
2. In the case of the simplest chemical cell lysis procedure (steps 1-3.), measure 25 μL 0.5 M NaOH solution into a 1.5 mL microcentrifuge tube that is labelled with the name of the bacterium strain.
3. Suspend a loopful of bacteria in the solution, vortex thoroughly and incubate for 15 minutes at room temperature.
4. Add 25 μL 1 M TRIS buffer and 300 μL dH_2O . Check the DNA quality with agarose gel electrophoresis (steps 10-13.).
5. In the case of an easy physical cell lysis procedure, measure 300 μL sterile glass beads and 100 μL dH_2O into a 600 μL microcentrifuge tube that is labelled with the name of the bacterium strain.
6. Suspend a loopful of bacteria and shake the tubes for 1 minute at 30 Hz in a mixer mill.
7. Spin the tubes quickly, and incubate for 5 minutes at 98°C (in a thermocycler or in a water bath).
8. Vortex for 5 seconds, centrifuge the tubes for 5 minutes at 10,000 g and transfer the supernatant (approx. 70 μL) to a new, labelled microcentrifuge tube. Check the DNA quality with agarose gel electrophoresis (steps 10-13.).
9. The procedure of DNA extraction using DNA isolation kits will be explained during the practical session (in general, follow the instructions given by the manufacturer). Check the DNA quality with agarose gel electrophoresis (steps 10-13.).
10. The first step of agarose gel electrophoresis is gel casting. In the case of 1 % agarose gel, add 8 mL 10 \times TBE solution to 0.8 g agarose and fill up to a final volume of 80 mL with distilled water. Boil until the agarose is completely dissolved, cool to approx. 50°C, and add 2.5 μL DNA stain to the solution and mix. Insert combs into the gel casting system, and pour the agarose solution into it. Fill the buffer tank of the electrophoresis apparatus with 1 \times TBE solution.
11. When the gel solidifies (requires 30-40 minutes), remove combs, and place the gel into the buffer tank.

12. Mix 5 μL DNA sample with 3 μL loading buffer, and load this mixture into the wells of the gel. To achieve a semi-quantitative measurement of DNA, load a 2- μL DNA ladder next to the samples.
13. Run electrophoresis for 20 minutes at 100 V, and detect the presence and quantity of DNA under UV light. Compare the quality and quantity of the three isolated DNA samples (e.g. fragmentation of DNA, signal intensity, approximate size compared to DNA ladder).
14. Store isolated DNA at -20°C for further analysis.

EXERCISE 78: AMPLIFICATION OF THE 16S rDNA WITH PCR AND PURIFICATION OF THE PCR PRODUCT

Smaller DNA fragments (<5000-10,000 bp) can be amplified by PCR (polymerase chain reaction). The whole process contains repeating thermal cycles with three steps in each cycle. During denaturation, DNA strands separate due to incubation at high temperature ($94-98^{\circ}\text{C}$). In the annealing step, forward and reverse primers (oligonucleotides) hybridise to complementary sites on single-stranded DNA chains at primer-dependent temperature. During extension, *Taq* DNA polymerase enzyme catalyses the synthesis of the complementary strands with extension from primers using the dNTPs present in the reaction mixture. This reaction amplifies the region located between the two primers logarithmically (Fig. 40 and 41).

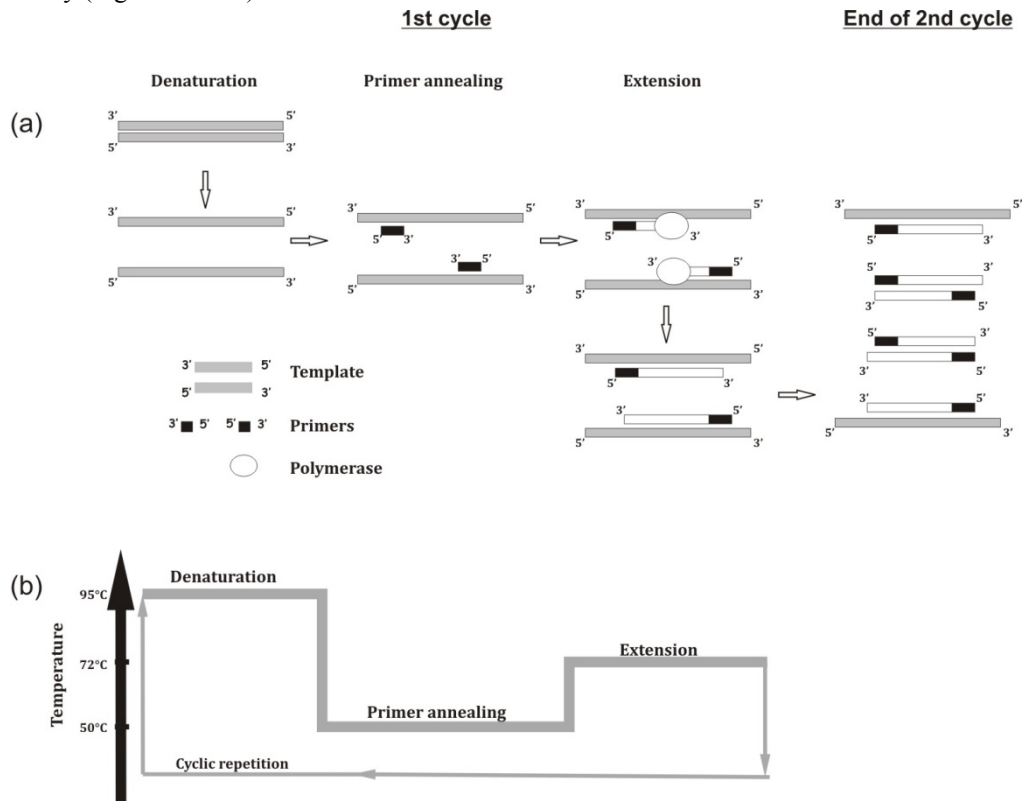

Fig. 40. Amplification of a DNA fragment with Polymerase Chain Reaction (PCR). (a) Outline of a general PCR procedure and (b) its temperature profile.

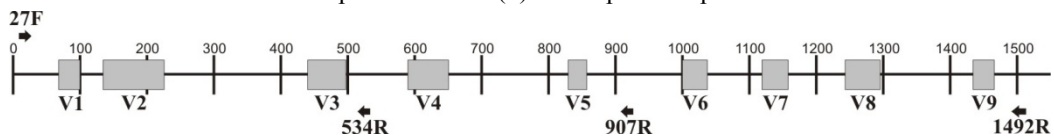

Fig. 41. Regions of the 16S rRNA gene and binding sites of selected universal primers. Numbering is according to the 16S rRNA gene of *Escherichia coli*. Primer binding sites are marked with arrows, whereas variable regions (V1-V9) are marked with gray rectangles.

Subsequent steps (e.g. sequencing reaction) may require the purification of PCR product from the polymerase enzymes: unbound nucleotides, DNA template and produced primer dimers. The principle of purification is similar

to the silicate-based DNA purification method described above (EXERCISE 77), which is used at DNA extraction. In this case, DNA with the proper size (e.g. 40 bp - 40 kbp) is retained and other DNA fragments (primer dimers and genomic DNA) are removed during the purification steps.

Object of study, test organisms:

genomic DNA extracted from bacterial strains

Materials and equipment:

micropipettes, sterile pipette tips
microcentrifuge and PCR tubes
microcentrifuge
microcentrifuge tube rack
10× PCR buffer
25 mM MgCl₂ solution
1 mM dNTP mix
forward and reverse primers:
 27f primer: 5' AGA GTT TGA TCM TGG CTC AG 3'
 1492r primer: 5' TAC GGY TAC CTT GTT ACG ACT T 3'
1 U/μL *Taq* polymerase enzyme
dH₂O [DEPC(diethyl pyrocarbonate)-treated distilled water]
vortex mixer
thermocycler
laboratory scales
250 mL flask
electrophoresis system
agarose
10× TBE solution (see Appendix)
measuring cylinder
DNA stain
loading buffer (see Appendix)
DNA ladder, Marker 3 (e.g. Lambda DNA *EcoRI/HindIII*, Fig. 39)
PCR product purification kit

Practise:

1. Let frozen DNA samples and PCR reagents thaw at room temperature.
2. Label a 1.5 mL microcentrifuge tube (this will be used for preliminary mixing of the master mix) and some PCR tubes (the amount is determined by the number of DNA samples plus two additional tubes for the positive and negative controls).
3. Make a preliminary mix using: 2.5 μL 10× PCR buffer, 2.0 μL MgCl₂, 5.0 μL dNTP mix, 0.25 μL forward primer, 0.25 μL reverse primer, 1.0 μL DNA sample, 0.5 μL *Taq* polymerase enzyme filled up to a final volume of 25 μL with dH₂O **per reaction** in a 1.5 mL microcentrifuge tube by multiplying the above amounts with the number of DNA samples plus three (for controls and pipetting errors; see Appendix). Do not add DNA samples and enzyme to the master mix!
4. Pipette 23.5 μL master mix into each labelled PCR tube, and add 1.0 μL DNA sample to the appropriate tubes. Do not add DNA to the negative control sample, but add DNA, which had been amplified successfully in a previous PCR, to the positive control sample. Vortex the tubes gently, and spin them quickly to collect the liquid on the bottom of the tubes.
5. Put all PCR tubes into the thermocycler and start the reaction with the following parameters: initial denaturation at 98°C for 5 min, followed by 94°C for 10 s, 32 cycles (denaturation at 94°C for 30 s, annealing at 52°C for 30 s, extension at 72°C for 30 s) and a final extension at 72°C for 10 min. Stop reaction at the '94°C for 10 s' step, and add 0.5 μL *Taq* polymerase enzyme to each tube. This is required, since the half-life of the enzyme

at 98°C is very short, and the addition of the enzyme directly to the master mix would result in the inactivation of a significant amount of the enzyme during the initial denaturation step.

6. Prepare 1 % agarose gel, and check the amount and quality of PCR products (EXERCISE 77, steps 9-12).
7. The procedure of PCR product purification with the kit will be explained during the practical session (in general, follow the instructions given by the manufacturer). Check the amount and quality of the purified PCR products by agarose gel electrophoresis as above (EXERCISE 77, steps 9-12). DNA quality might be slightly lower as compared to the PCR product prior to purification and small-sized DNA fragments (e. g. primer dimmers) are wasted anyway.
8. Purified and unpurified PCR products can be stored for a few days at 4°C. Long-term storage should be achieved at -20°C.

EXERCISE 79: RESTRICTION DIGESTION OF PCR PRODUCTS

In the case of analysing a large number of bacterial strains, the construction of groups with PCR products originating from the same bacterial species can avoid redundant sequencing. To achieve this, a fast, cheap and effective method of genotyping, Amplified Ribosomal DNA Restriction Analysis (ARDRA), could be applied. In ARDRA, the amplified 16S rDNA molecules are digested with restriction enzymes. Comparing different bacterial species, the number and position of restriction sites within this region is variable. Following enzymatic digestion, gel electrophoresis results in patterns that are characteristic for bacterial species, and could serve as a basis of grouping (Fig. 42). (The methodology of this technique makes the categorisation of regions with different nucleotide sequence to the same pattern group possible!)

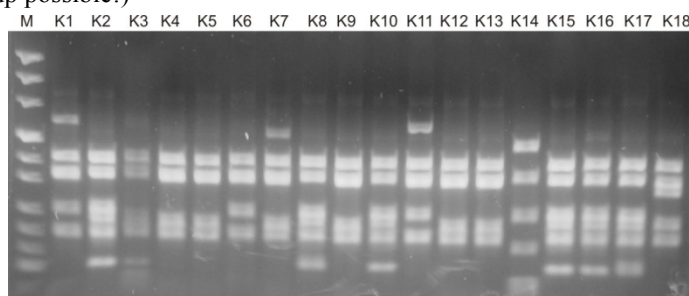

Fig. 42. Amplified Ribosomal DNA Restriction Analysis (ARDRA) pattern of PCR products. Image of the agarose gel. The 16S rDNA PCR products from bacterial pure cultures (K1-K19) were digested with the *Hin6I* enzyme. The first lane contains DNA ladder, Marker 8 (M).

Enzymatic digestion yields smaller DNA fragments compared with PCR products, therefore their separation requires higher resolution. This could be achieved by increasing the electrophoresis time and gel concentration, and lowering the voltage applied for electrophoresis.

Object of study, test organisms:

PCR products

Materials and equipment:

micropipettes, sterile pipette tips
 microcentrifuge tubes
 microcentrifuge
 microcentrifuge tube rack
 restriction enzymes and enzyme buffers
 dH₂O [DEPC(diethyl pyrocarbonate)-treated distilled water]
 vortex mixer
 water bath
 laboratory scales
 250 mL flask
 electrophoresis system

agarose
 10×TBE solution (see Appendix)
 measuring cylinder
 DNA stain
 loading buffer (see Appendix)
 DNA ladder (e.g. pUC Mix, Marker 8, Fig. 39)
 gel documentation system
 computer with installed pattern analysis software (e.g. TotalLab)

Practise:

1. Let frozen PCR products and enzyme buffers thaw at room temperature.
2. Label a 1.5 mL microcentrifuge tube (this will be used for the master mix) and some 0.6 mL microcentrifuge tubes [the amount is calculated in a similar way as for PCR products (EXERCISE 78, step 2)].
3. Make a master mix using 0.3 µL enzyme (10 U/µL), 2.0 10× enzyme buffer and 9.7 µL dH₂O per reaction in a 1.5 mL microcentrifuge tube and multiply the above amounts by the number of PCR products plus one (see Appendix).
4. Pipette 12 µL master mix to each labelled 0.6 mL microcentrifuge tube, and add 8 µL PCR product to the appropriate tubes. Vortex the tubes gently, and spin them quickly to collect the liquid on the bottom of the tubes. Incubate the tubes for 3 hours in a water bath at the given temperature (**Table 7**).

Table 7. Major features of selected restriction endonucleases

Enzyme	Buffer	Recognition and restriction site	Optimal temperature
<i>AluI</i>	Y+/Tango	5' AG ↓CT	37°C
<i>BsuRI</i>	R+ (red)	5' GG ↓CC	37°C
<i>Hin6I</i>	Y+/Tango	5' G ↓CG ↑C	37°C
<i>TaqI</i>	Taq	5' T ↓CG ↑A	65°C

1. Prepare 2% agarose gel (use 1.6 g agarose instead of 0.8 g) (EXERCISE 77, steps 9-12.)
2. Mix the total amount of digested PCR samples (20 µL) with 8 µL loading buffer, and load this mixture into the wells of the gel. To achieve a semi-quantitative measurement of DNA, load 3 µL DNA ladder next to the samples.
3. Run the electrophoresis for 80 minutes at 80 V, and detect the presence and quantity of DNA under UV light. Make a digital image using a gel documentation system.
4. Perform the pattern analysis with the adequate software in accordance with the explanation during the practical session. Create groups based on the number and position of DNA fragments.

EXERCISE 80: DNA NUCLEOTIDE SEQUENCE ANALYSIS

Dye-terminator cycle sequencing reaction is a general method to determine the nucleotide sequence of DNA fragments. The reaction is similar to PCR, but contains only one primer, and in addition to dNTPs, fluorescently labelled ddNTPs (four different colours corresponding to the four different nucleotide types) are also applied in the reaction. If a ddNTP is incorporated into the DNA during the extension of DNA chains, reaction terminates, since ddNTP molecules do not allow the incorporation of additional nucleotides. Finally, DNA fragments with different lengths are produced, which are fluorescently labelled corresponding to the terminal nucleotide. After the completion of sequencing reaction, ethanol precipitation is applied to remove enzyme molecules and unbound nucleotides. Following purification, DNA fragments are separated by capillary electrophoresis, in which the different fluorescent signals are detected with laser excitation in the order of the size of the product. Subsequently, chromatograms are created by adequate software (Fig. 43).

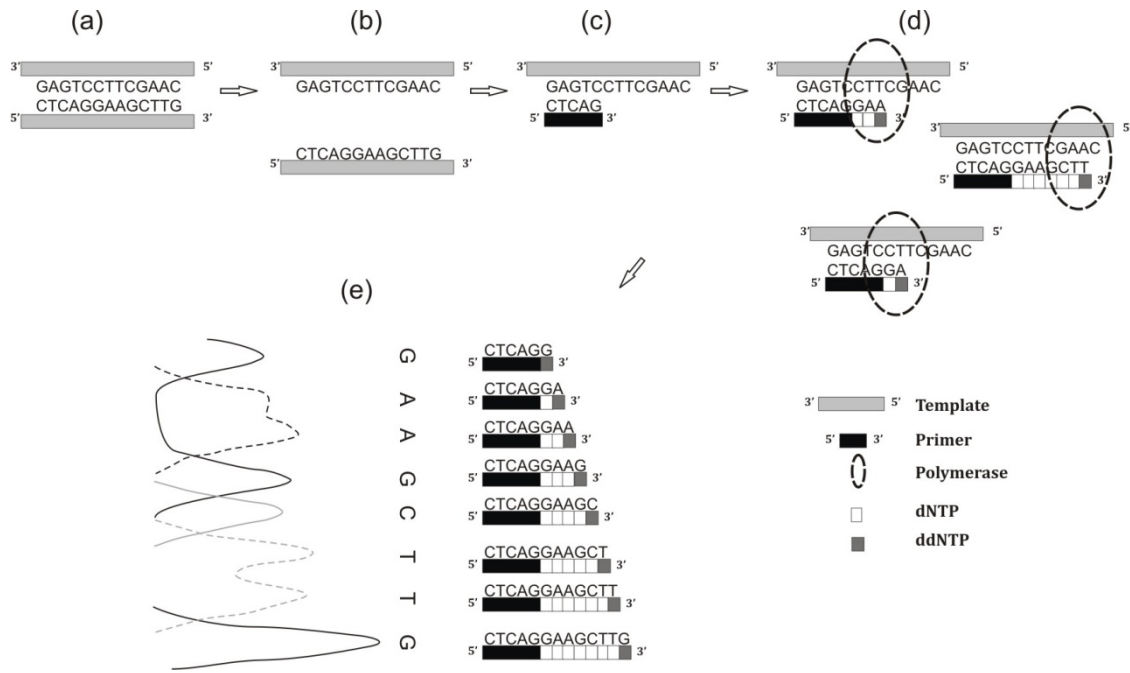

Fig. 43. DNA sequencing analysis. (a) PCR product (b) Denaturation (c) Primer annealing (d) Extension: each reaction terminates with the incorporation of a ddNTP (e) Capillary electrophoresis: fragments are size separated and each ddNTP is detected at a different wavelength, marked with different lines.

The basis of correct taxon identification is a sequence of good quality. Sequencing biases could arise during both the reaction and capillary electrophoresis. Some of them can be circumvented by precise laboratory work, but the quality of electrophoresis and automatic base calling on chromatograms should be checked and corrected manually, if required.

Object of study, test organisms:

purified PCR products

Materials and equipment:

- micropipettes, sterile pipette tips
- microcentrifuge (refrigerated) and PCR tubes
- microcentrifuge tube rack
- ABI BigDye[®] Terminator v3.1 Cycle Sequencing kit:
 - Ready Reaction Mix, 5× sequencing buffer
- primers:
 - 534r primer: 5' ATT ACC GCG GCT GCT GG 3'
 - 907r primer: 5' CCG TCA ATT CMT TTG AGT TT 3'
 - 1492r primer: 5' TAC GGY TAC CTT GTT ACG ACT T 3'
- dH₂O [DEPC(diethyl pyrocarbonate)-treated distilled water]
- vortex mixer
- thermocycler
- 3 M Na-acetate solution (pH 4.6)
- 95% ethanol and 70% ethanol
- vacuum centrifuge
- formamide
- ABI Prism[™] 310 genetic analyzer
- computer with installed MEGA software

Practise:

1. Let frozen purified PCR products and reagents thaw at room temperature.

2. Label three 1.5 mL microcentrifuge tubes (this will be used for the three master mixes), and some PCR tubes (threefold as the number of purified PCR products).
3. Make a master mix using 1.5 μ L 5 \times sequencing buffer, 1.0 μ L Ready Reaction Mix, 0.5 μ L primer and 4.0 μ L dH₂O per reaction in a 1.5 mL microcentrifuge tube (one master mix for each primer), multiply the above amounts by the number of purified PCR products plus one (see Appendix). (The three master mixes for the three primers should be prepared in separate tubes!)
4. Pipette 7 μ L master mix into each labelled PCR tube, and add 3 μ L purified PCR product to the appropriate tubes. Vortex the tubes gently, and spin them quickly to collect the liquid on the bottom of the tubes.
5. Put all PCR tubes into the thermocycler, and start the reaction with the following parameters: 28 cycles with denaturation at 96°C for 30 s, annealing at 50°C for 5 s and extension at 60°C for 4 min.
6. Until the sequencing reaction is complete, prepare the master mix for ethanol precipitation. Add 62.5 μ L 95% ethanol, 3.0 μ L 3M Na-acetate and 14.5 μ L dH₂O per reaction into a 1.5 mL microcentrifuge tube, multiply the given amount by sample number plus one (see Attachment).
7. Pipette 80 μ L master mix to each labelled 0.6 mL microcentrifuge tube, and add the total volume (10 μ L) of the sequencing reaction to the appropriate tubes. Vortex the tubes vigorously, and incubate them for 15 minutes at room temperature.
8. Centrifuge the tubes for 20 minutes at 18,000 g at 4°C, and carefully remove the supernatant by pipetting.
9. Add 250 μ L 70% ethanol, vortex the tubes vigorously, and centrifuge for 10 minutes at 18,000 g. Remove the supernatant by pipetting.
10. Dry the precipitate on the bottom of the microcentrifuge tubes in a vacuum centrifuge.
11. Add 20 μ L formamide to the pellets, vortex and spin them quickly. Denature samples in a thermocycler for 5 minutes at 95°C. Run the capillary electrophoresis as explained during the practical session. Genetic analyser software will perform automatic base calling for each chromatogram.
12. Start the MEGA software, and open the alignment window (Align>Edit/Build Alignment>Create a new alignment). Open the first chromatogram (Sequencer>Edit Sequencer file). Remove low quality data from the beginning of the sequence. In the case of sequencing with a reverse primer, the reverse complement of the sequence should be used for further analysis (Edit>Reverse complement). Find all ambiguous nucleotides (marked with N in the nucleotide sequence, Ctrl+N), and make manual correction, if possible. Remove low quality reads and the primer sequence from the end of the chromatogram. Save data in an '.ab1' format (Data>Save file), and import data to the alignment window (Data>Add to Alignment Explorer). Perform the same steps with all chromatograms.
13. Find the overlapping regions of sequences obtained from the same PCR product (Search>Find motif). Use 'Copy – Paste' functions to assemble the 16S rDNA, and finally save the result.

EXERCISE 81: DISTINGUISHING BACTERIAL STRAINS USING THE RAPD FINGERPRINTING TECHNIQUE

PCR was applied as an intermediate step for DNA amplification in the case of ARDRA or sequence analysis in the former exercises. However, special PCRs are suitable for the direct genotyping of bacterial strains, generating individual fingerprinting patterns.

Such a method is rep-PCR (Repetitive Extragenic Palindromic PCR), which amplifies repetitive elements having different multiplicity and located in various loci within the genome, e.g. REP, ERIC and BOX elements.

Another methodological alternative is the RAPD technique (Random Amplification of Polymorphic DNA) that uses one or several short primers for amplification. Low annealing temperatures applied in the PCR allow the random attachment of primers to different regions within the genome, which results in PCR products of various lengths. The prerequisite of a RAPD analysis is a genome as intact as possible, therefore such a DNA extraction procedure must be chosen that does not significantly fragment genomic DNA.

PCR products are analysed with electrophoresis, and dendrograms can be constructed from the resulting patterns (Fig. 44).

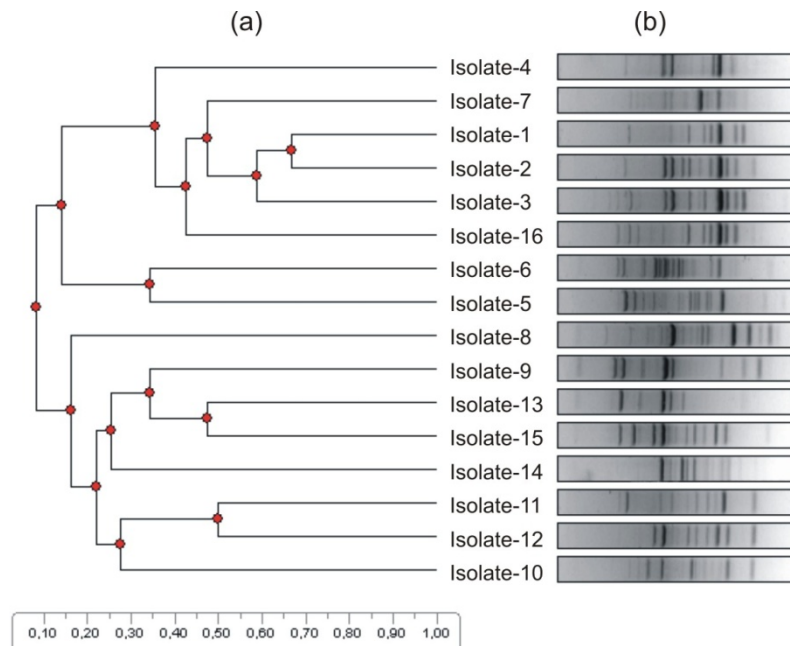

Fig. 44. Clustering of strains with the RAPD fingerprinting technique. (a) Dendrogram of *Synechococcus* isolates based on RAPD fingerprinting. (b) Image of the agarose gel.

Object of study, test organisms:

bacterial slant cultures

Materials and equipment:

reagents and equipment required for DNA extraction (see EXERCISE 77)
 micropipettes, sterile pipette tips
 microcentrifuge and PCR tubes
 microcentrifuge
 microcentrifuge tube rack
 10× PCR buffer
 25 mM MgCl₂ solution
 1 mM dNTP mix
 M13 primer: 5' GAG GGT GGC GGT TCT 3'
 1 U/ μL *Taq* polymerase enzyme
 dH₂O [DEPC(diethyl pyrocarbonate)-treated distilled water]
 vortex mixer
 thermocycler
 laboratory scales
 250 mL flask
 electrophoresis system
 agarose
 10× TBE solution (see Appendix)
 measuring cylinder
 DNA stain
 loading buffer (see Appendix)
 DNA ladder (e.g. pUC Mix, Marker 8, Fig. 39)
 gel documentation system
 computer with installed pattern analysis software (e.g. TotalLab)

Practise:

1. Isolate DNA from bacterial strains applying the chemical cell lysis procedure (see EXERCISE 77).
2. Let frozen PCR reagents melt at room temperature.
3. Label a 1.5 mL microcentrifuge tube (this will be used for the master mix) and some PCR tubes (same as the number of DNA samples plus two, these additional tubes will contain the positive and negative controls).
4. Make a master mix using 2.5 μL 10 \times PCR buffer, 3.0 μL MgCl_2 , 6.0 μL dNTP mix, 2.0 μL M13 primer, 1.0 μL DNA sample, 1 μL *Taq* polymerase enzyme filled up to a final volume of 25 μL with dH_2O per reaction in a 1.5 mL microcentrifuge tube, and multiply the above amounts with the number of DNA samples plus three (for controls and pipetting errors, see Appendix). Do not add DNA samples and enzyme to the master mix!
5. Pipette 23.5 μL master mix to each labelled PCR tube, and add 1.0 μL DNA sample to the appropriate tubes. Do not add DNA to the negative control sample, but add DNA, which had been amplified successfully in a previous PCR, to the positive control sample. Vortex the tubes gently, and spin them quickly to collect the liquid on the bottom of the tubes.
6. Put all PCR tubes into the thermocycler, and start the reaction with the following parameters: initial denaturation at 98°C for 5 min, followed by 94°C for 10 s, 35 cycles (denaturation at 94°C for 90 s, annealing at 56°C for 2 min, extension at 72°C for 2 min) and a final extension at 72°C for 10 min. Stop reaction at the '94°C for 10 s' step, and add 1 μL *Taq* polymerase enzyme to each tube. This is required, since the half-life of the enzyme at 98°C is very short, and the addition of the enzyme directly to the master mix would result in the inactivation of a significant amount of the enzyme during the initial denaturation step.
7. To achieve the appropriate result, PCR reaction should be performed in three replicates (steps 3-6.), since some intra-sample variability may be observed due to the random annealing of primers to the genomic DNA.
8. Prepare 2% agarose gel (use 3 g of agarose instead of 0.8 g, and dissolve in 150 mL of 1 \times TBE buffer) (see also EXERCISE 77, steps 9-12.). (Do not insert combs into the centre of the gel!)
9. Mix the total amount of PCR product (25 μL) with 8 μL loading buffer, and load this mixture into the wells of the gel. To achieve a semi-quantitative measurement of DNA, load 3 μL DNA ladder next to the samples.
10. Run the electrophoresis for 140 minutes at 80 V, and detect the presence and quantity of DNA under UV light. Make a digital image using a gel documentation system.
11. Perform the pattern analysis with the adequate software in accordance with the explanation during the practical session.

Metabolic potential of microbes can be studied with the detection of genes encoding proteins involved in a particular metabolic pathway or with the examination of proteins indicating general metabolic activity (e.g. applying PCR-based methods or hybridisation). The presence of a gene in the genome does not indicate unequivocally that the corresponding protein is produced within the cell, therefore its detection serves only indirect information on a certain function. RNA-based studies are one step closer to the detection of real function, since the presence of transcribed RNA within the cell indicate a certain potential. Furthermore, the amount of mRNA is also indicative to the degree of the particular activity (more mRNA serves as more template in the translation). For a thorough quantitative analysis, it should also be investigated if the studied gene has the same (or at least similar) copy number within the genome of different taxa.

In some cases, metabolic genes also carry phylogenetic information (**Table 8**), and activity could be coupled with the genetic diversity (species composition) of the studied environment. However, phylogenetic information could be blurred by the lateral gene transfer of these genes. Due to the degenerate character of the genetic code (a particular amino acid is encoded by more than one triplet), protein-coding regions are more variable than the 16S rDNA, therefore phylogenetic analyses with higher resolution can be performed (e.g. in the case of closely related taxa).

Table 8. Some metabolic genes/genomic regions used in the studies of metabolic activity or in phylogenetic analyses

Genomic region	Encoded gene(s)	Major features
<i>cpeB(A)</i>	phycoerythrin genes	gene(s) encoding phycobilisome protein(s), present only in cyanobacteria and red algae
<i>cpcBA</i> -IGS	phycocyanin operon	genes encoding phycobilisome proteins, present only in cyanobacteria and red algae
<i>psbA</i>	D1 protein of photosystem II	lateral gene transfer is possible by viral contribution; in some algae, copies with different nucleotide sequences can be found
<i>rbcL</i>	gene encoding the large subunit of RuBisCO	gene encoding the subunit of a key enzyme in CO ₂ -fixation, lateral gene transfer among taxonomic groups exists
<i>rpoC1</i>	a gene of the DNA-dependent RNA polymerase enzyme	present in a single copy in the prokaryotic genome
<i>amoA</i>	subunit A of the ammonia-monooxygenase enzyme	subunit of the enzyme catalysing the rate limiting step of ammonia oxidation
<i>nirS</i>	cytochrome <i>cd₁</i> type nitrite reductase gene	enzyme catalyses an intermediate step of denitrification, only one of the two types is present within a bacterium strain, lateral gene transfer among taxonomic groups exists
<i>nirK</i>	copper-containing nitrite reductase gene	
<i>nosZ</i>	nitrous oxide reductase gene	enzyme catalyses the last step of denitrification, not present in all denitrifying bacteria
<i>dsrAB</i>	dissimilatory sulfite reductase genes	characteristic genes of sulphate reducing bacteria
<i>nifH</i>	a component of the nitrogenase enzyme (dinitrogenase reductase)	in the case of fast-growing <i>Rhizobium</i> species, these genes are located on plasmids, while in the case of slow-growing <i>Rhizobium</i> species, these genes can be found on the chromosome
<i>nodD</i>	gene involved in the first step of nodulation	
<i>catA</i>	catechol 1,2-dioxygenase gene	encoding a key enzyme in the degradation of monoaromatic pollutants

Chapter 8. ANALYSIS OF THE MICROBIOLOGICAL QUALITY OF DIFFERENT ENVIRONMENTS

8.1. Microbiology of surface waters and wastewaters, hygienic control

In natural continental waters, bacteria originate from different habitats as follows: indigenous bacteria of water (e.g. *Spirillum*, *Vibrio*, *Pseudomonas*, *Chromobacterium*, *Flavobacterium* species); soil bacteria (e.g. *Bacillus*, *Streptomyces*, *Aerobacter* species) and bacteria of faecal origin (e.g. *Escherichia coli*, *Streptococcus faecalis*, *Clostridium welchii*).

The quality of natural waters can be examined from different (e.g. hygienic) aspects. In Hungary, the rules of bacteriological qualification of natural waters (e.g. surface waters, bathing waters) are given in standards (e.g. MSZ 12749/1993, MSZ 13693/3-1989). The quality requirements and the methods of drinking water control are regulated by the Government Statute 201/2001 (X. 25.).

In hygienic practise, indicator organisms are used to qualify the bacterial characteristics of water. Their presence in the water indicates whether the water is contaminated by human pathogenic microbes. The characteristics of indicator organisms are:

- Should be informative in all types of waters (drinking water, lake, river, seawater, wastewater, etc).
- Must be present everywhere where pathogens are also present.
- Cannot be obligate pathogen.
- Characterised by longer survival time than the general enteral pathogenic microbes.
- Their quantity must show direct correlation with the degree of faecal contamination.
- The methods applied for the detection of indicator organisms must be highly specific.
- Test methods must be easily applicable.

Coliform bacteria (e.g. *E. coli*, *Enterobacter aerogenes*, *Klebsiella pneumoniae*) are good indicator organisms. They are not generally pathogenic, but their presence shows that faecal contamination of water has occurred. Coliforms in hygienic practice are defined as facultative anaerobic, Gram-negative, non-endospore-forming, rod-shaped bacteria that ferment lactose by producing acid and gas within 48 hours at 37°C. Coliforms are members of the family Enterobacteriaceae. The values of coli-count and coli-titer are used for the quantitative characterisation of coliform organisms in a given water sample. Coli-titer is the smallest amount of water from which coliform organisms can still be cultivated. Coli-count (Coli-index or coliform density) is the number of coliform bacteria that can be cultivated from 100 mL of water sample.

To identify coliform bacteria, different media can be used.

Eosin-Methylene Blue (EMB) agar is one of the most efficient differential media. It differentiates lactose-fermenting bacteria based on the fact that the acid produced during lactose fermentation precipitates eosin, which is coloured by the methylene blue dye content of the medium, so that the positive bacterial colonies on the surface of the EMB medium display a purplish blue coloration. The medium also contains sucrose, which helps the growth of other microbes, but later the dye inhibits their growth.

Within the Endo agar, the dark red alkaline fuchsin is decolourised by sodium sulphite (Na_2SO_3). Acetaldehyde is one of the intermediate compounds during lactose fermentation, which binds sulphite, thus the colour of the fuchsin becomes visible. The typical coliform organisms dye the Endo-agar red, and grow on the surface of the agar as dark red colonies with a metallic shine.

EXERCISE 82: COLI-COUNT DETERMINATION BY MEMBRANE FILTER TECHNIQUE

ANALYSIS OF THE MICROBIOLOGICAL QUALITY OF DIFFERENT ENVIRONMENTS

A membrane filter of 0.45 µm pore size is generally used to remove bacteria from solutions (see EXERCISE 17)

Object of study, test organisms:

water sample (drinking water)

Materials and equipment:

measuring cylinder
0.45µm pore size membrane filter
sterile filtration equipment
Endo agar plate (see Appendix)
Eosin-Methylene Blue (EMB) agar plate (see Appendix)
forceps
Bunsen burner
incubator

Practise:

1. Filter 100 mL of water sample through a 150 µm thick and 0.45 µm pore size sterile membrane filter.
2. Remove the membrane filter and place it facing up onto the surface of adequate differential medium (Endo- or Eosin-Methylene Blue agar plates) using sterile forceps.
3. Incubate the plates at 37°C for 24 hours and count the number of colonies formed. If the filtered water sample was not diluted prior to filtration, the Coli-count of 100 mL water sample is equal to the number of coliform colonies counted on the agar surface.

EXERCISE 83: COLI-COUNT DETERMINATION BY SPREAD PLATE TECHNIQUE

Object of study, test organisms

contaminated water sample

Materials and equipment:

9 mL sterile distilled water in test tubes
pipettes, sterile pipette tips
Endo agar plate (see Appendix)
Eosin-Methylene Blue (EMB) agar plate (see Appendix)
glass spreader (alcohol for sterilisation)
Bunsen burner
incubator

Practise:

1. Prepare a ten-fold dilution series from the contaminated water sample (see EXERCISE 15).
2. Spread 0.1-0.1 mL of each dilution onto the surface of Endo agar and Eosin-Methylene Blue agar plates.
3. Incubate the plates at 37°C for 24 hours.
4. Evaluate the number of typical coliform colonies and calculate the coli-count for 100 mL water sample.

EXERCISE 84: COLI-COUNT DETERMINATION BY MPN METHOD IN LMX BROTH

Coli-count of a water sample can be determined also by MPN method (see EXERCISE 18) with LMX medium. The LMX medium contains MUG (4-methylumbelliferyl-β-D-glucuronide) substrate, which can be cleaved by the glucuronidase enzyme, cleaving off a compound that shows fluorescence at 366 nm under UV light. Among the Gram-negative bacteria, 96% of *E. coli*, 100% of enterotoxigenic *E. coli*, 44% of certain *Shigella* species and 17% of bacteria belonging to the genus *Salmonella* produce this enzyme.

Object of study, test organisms:

contaminated water sample

Materials and equipment:

LMX broth (see Appendix)
50 mL Erlenmeyer flask
pipette, sterile pipette tips
96-well microtiter plate
sterile 16x100 mm test tubes
vortex mixer
incubator
UV lamp (366 nm)

Practise:

1. Prepare a dilution series from the water sample as follows: measure 3 mL water sample into 27 mL LMX broth in a 50 mL Erlenmeyer flask. Homogenize the sample with vortex or in a shaker for 15 minutes at 20°C. Prepare an 8-member dilution series from the obtained suspension so that you carry 0.3 mL of the sample suspension into a test-tube containing 2.7 mL of LMX broth. Mix vigorously (vortex) then transfer again 0.3 mL suspension into a new test tube, and so on (Fig. 17).
2. From each dilution (including the original sample), pipette 300 µl into a 96-well microtiter plate in five parallels (5 test-tube MPN method).
3. Incubate the microtiter plates at 37°C for 24 hours.
4. Evaluation of the results: the *E. coli* count is determined by counting the fluorescent wells (under UV-lamp at 366 nm) of the plate and transforming it to the appropriate McCarty characteristic number (see Appendix).

EXERCISE 85: DETERMINATION OF COLIPHAGES FROM SURFACE WATERS BY THE POUR-PLATE TECHNIQUE

Phages replicate rapidly in their bacterial hosts indicating the presence of their host in a given environment. The phage that infects *Escherichia coli* is called coliphage. To test the presence and abundance of such phages, a sample containing coliphage is added to the bacteria in soft agar prior to pouring the plate. If coliphages lyse (burst) cells while *Escherichia coli* is multiplying in the overlay, plaques (clear zones) develop in the lawn of bacteria. Using bacteriophages as faecal indicators from an environmental sample is a relatively new technique in the microbiological analysis of water samples.

Object of study, test organisms:

contaminated water sample

Materials and equipment:

suspension of ATTC 13706 *Escherichia coli* strain (24-hour culture)
sterile 100 mL Erlenmeyer flask
measuring cylinder
water bath
4 mL CaCl₂ solution
TTC (triphenyl-tetrazolium-chloride)
5 mL 96% ethanol
pipettes, sterile pipette tips
100 mL sterile molten nutrient agar medium (see Appendix)
sterile, empty Petri-dishes
Bunsen burner
incubator

Practise:

1. Measure 100 mL water sample into a sterile flask and incubate in a water bath of 45°C-47°C.
2. Pipette 4 mL sterile CaCl₂ solution into the flask and incubate for 10 minutes. Meanwhile, dissolve 0.05 g of TTC (triphenyl-tetrazolium-chloride) in 5 mL 96% ethanol.
3. Pipette 1 mL of the 1% TTC solution and 1.2 mL of the CaCl₂ solution into 100 mL molten nutrient agar medium.
4. Inoculate the water sample with 5 mL previously shaken (at 37°C) *Escherichia coli* (ATTC 13706) suspension.
5. Carefully and slowly pour the medium into the water sample and slowly mix it, then pour it into a sterile big Petri dish avoiding the formation of any bubbles.
6. Incubate at 37°C for up to a week. Bacterial growth is indicated by the reduction of TTC to the red triphenyl-phormazane compound. Phages are highlighted by lack of red colourisation.
7. Estimate the number of coliphages of 1 mL contaminated water sample based on the number of plaques formed.

EXERCISE 86: DEMONSTRATION OF *STREPTOCOCCUS* OF FAECAL ORIGIN USING THE MEDIUM SZITA E-67

Along with *Staphylococcus*, the members of the genus *Streptococcus* are the most important bacteria among Gram-positive cocci. There are some that are equally pathogenic for animals and humans but healthy individuals can also carry them.

Streptococcus faecalis (*Enterococcus faecalis*) dies in water quickly, however its evaluation is important, since, as opposed to *E. coli* (which can be found almost anywhere), *S. faecalis* does not reproduce in non-faecal environment. Thus its presence underlines the results of *E. coli* testing and indicates the fresh faecal contamination of water.

In clinical, epidemiological laboratory practice, the agar medium Szita E-67 is generally used for the cultivation of *Streptococcus*. The selectivity of the Szita E-67 medium for *Streptococcus* is assured by the tellurite and Na-taurocolate content of the medium. *Streptococcus faecalis* reduces tellurite within the medium and forms black colonies on the surface of the Szita E-67 agar, while other bacteria grow hardly at all.

Object of study, test organisms:

contaminated water sample

Materials and equipment:

Szita E-67 agar plates (see Appendix)
glass spreader (alcohol for sterilisation)
pipette, sterile pipette tips
Bunsen burner
incubator

Practise:

1. Prepare a serial dilution from the contaminated water sample.
2. Spread 0.1-0.1 mL of each dilution onto the surface of Szita E-67 agar plates.
3. Incubate the plates at 37°C for 24 hours.
4. Observe the characteristic black *Streptococcus* colonies. Calculate a *Streptococcus*-count from the amount of such colonies in 100 mL contaminated water sample.

(See also Supplementary Figure S32.)

EXERCISE 87: CULTURING PSEUDOMONADS ON BROLACIN AGAR

Members of the genus *Pseudomonas* are widely distributed in soil and water. Pseudomonads are Gram-negative, strictly respiring, mostly obligate aerobic bacteria with polar flagella. Among them, *Pseudomonas aeruginosa* is a common bacterium in different waters, wastewaters and contaminated waters. For the detection of the members of the genus *Pseudomonas*, brolacin nutrient medium is used, which contains lactose, peptone, cystine and bromothymol-blue indicator (green at neutral pH). Colonies of Pseudomonads appear brown in the centre and dye the surrounding area of the agar blue. The presence of pseudomonads does not indicate fresh contamination, however it can often be found inside hospital plumbing units (taps, pipelines, etc.) and equipment. These microbes usually attack weak patients, immunocompromised individuals and those who received radiation or antibiotic treatment.

Object of study, test organisms:

contaminated water sample

Materials and equipment:

Brolacin agar plate (see Appendix)
glass spreader (alcohol for sterilisation)
pipette and sterile pipette tips
Bunsen burner
incubator

Practise:

1. Prepare a ten-fold dilution series from the contaminated water sample.
2. Spread 0.1-0.1 mL of each dilution onto the surface of brolacin agar plates.
3. Incubate the plates at 37°C for 24 hours.
4. Observe the brown centered colonies with blue zones around them. Calculate a *Pseudomonas*-count from the amount of such colonies in 100 mL water sample.

(See also Supplementary Figure S31.)

8.2. Soil examinations

During the analysis of soil microbiota, it is worth to examine microbial activities in parallel with the plate count estimates (or biomass determination).

EXERCISE 88: RAPID TEST FOR THE DETECTION OF SOIL CATALASE ENZYME ACTIVITY

We can judge the quantity and activity of microorganisms on the basis of catalase activity in a soil sample. Strong catalase activity suggests the presence of many soil microorganisms, which play a significant role in the decomposition of organic matter and humus formation. It is important to note that in addition to microbes, catalase enzyme is also produced in plant residues.

Object of study, test organisms:

4 to 5 different types of air-dried soil samples

Materials and equipment:

sieve
syringe
100 mL Erlenmeyer flasks
bored rubber stopper with a plastic tube
measuring cylinder
3% hydrogen peroxide solution

Practice:

1. To remove small plant residues, sift the air-dried soil samples carefully.
2. Measure 5 g soil sample into a 100 mL Erlenmeyer flask and then close the mouth of the flask with a bored rubber stopper.
3. Introduce a tube through the hole of the rubber stopper. The other end of the tube should end in an inverted ("upside-down") and water-filled measuring cylinder. Using a syringe, add 10 mL 3% hydrogen peroxide to the soil sample. The soil catalase breaks down the hydrogen peroxide into water and oxygen. Rotate the flask continuously for 3 minutes, and then observe the decrease of the water level in the measuring cylinder. It indicates the amount of oxygen produced.
4. Calculate the obtained measurement results with reference to one minute.
5. Repeat the measurement with the other soil samples.
6. Compare catalase activity of different soils.

EXERCISE 89: ESTIMATION OF SOIL MICROBIAL ACTIVITY BY MEASURING CO₂ PRODUCTION

For the estimation of the aerobic biological activity of soil samples, primarily the measurement of CO₂ production can be used. As an example, aerobic decomposition of organic materials is presented with glucose. During oxidation of glucose to CO₂, the O₂ which serves as the terminal electron acceptor is reduced to H₂O. Meanwhile, energy (ATP) and reducing power (NADH) are both generated, which allow the conversion of a part of the organic matter into cell material.

In contrast to the ideal case shown above, in reality, the amount of CO₂ produced depends on the biodegradability of the organic substrate and the metabolic efficiency of microorganisms participating in the process.

The easiest way is the use of the traditional "Biometer" flasks for such measurements. In this case, the produced CO₂ is trapped in KOH solution.

Object of study, test organisms:

different types of soil samples

Materials and equipment:

250 mL Biometer flask
N KOH solution
freshly boiled distilled water
2N BaCl₂ solution
100 mL Erlenmeyer flasks
0.05N HCl solution
phenolphthalein indicator
laboratory scales
chemical spoons
20 mL plastic syringes
burette
glass dropper dispenser
pipette, sterile pipette tips
incubator

Practice:

1. Measure 50 g of a soil sample into a Biometer flask.
2. Using a syringe, measure 15 mL 0.1N KOH solution into the side tube of the Biometer flask (leave the syringe on the side tube), and then close the flask.

3. Incubate at 10°C for the period specified by the instructor.
4. Transfer the KOH solution from the side tube to the 100 mL Erlenmeyer flask with the syringe.
5. Using the syringe, wash the side tube with 35 mL freshly boiled distilled water (free of CO₂). Pour the washing solution into the 100 mL Erlenmeyer flask.
6. Fill the side tube again with 15 mL 0.1N KOH solution, and close it.
7. Incubate at 10°C for the period specified by the instructor, and perform steps 4-5.
8. Pipette 1 mL 2N BaCl₂ solution and add 1 drop of phenolphthalein indicator into the 100 mL Erlenmeyer flask containing the obtained 50 mL solution (15 mL KOH + 35 mL washing solution).
9. Titrate the contents of the 100 mL flasks using 0.05N HCl solution.
10. Using the volume of HCl consumed during titration, calculate the amount of CO₂ produced with the following formula:

$$V_{\text{CO}_2} = 1.175 \times 10^{-5} \times C_{\text{HCl}} \times (V_{\text{KOH}} - V_{\text{SAMPLE}}),$$

where V_{CO_2} is the amount of CO₂ produced in m³, C_{HCl} is the concentration of HCl solution (mol/L), V_{KOH} is the amount of consumed HCl solution in mL in case of 15 mL KOH (which refers to the CO₂ content of the KOH solution), V_{SAMPLE} is the amount of HCl consumed in mL in case of KOH solution removed after incubation.

8.3. Examination of microorganisms participating in the nitrogen cycle

Nitrogen occurs in nature in different oxidation states, mostly in the molecules transformed by different living organisms (Fig. 45). Many of the processes are catalysed only by microorganisms.

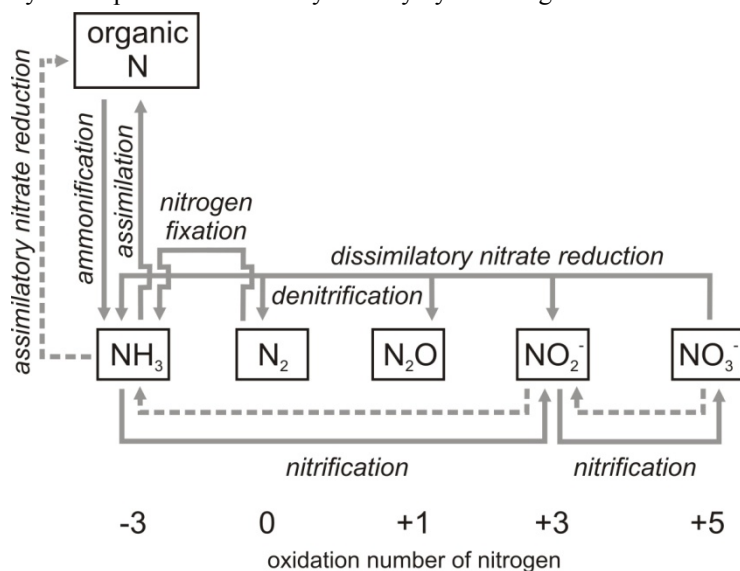

Fig. 45. The nitrogen cycle. Nitrogen compounds are shown in rectangles. The different nitrogen transformation processes are indicated with arrows.

Biological nitrogen fixation is carried out by prokaryotic organisms only. During the process of nitrogen fixation, the oxidation state of the nitrogen atom is reduced from 0 (nitrogen gas) to -3 (ammonia). The ammonia gained by nitrogen fixation can later be assimilated by organic compounds.

Nitrogen-fixing organisms can be divided into two major groups: free-living organisms (e.g. *Azotobacter*, *Clostridium*, *Anabaena*) and symbionts of higher/other organisms (close association). The latter group consists

mostly of the members of the genus *Rhizobium*, which are associated with leguminous plants (e.g. peas, beans, soybean). Free-living rods infect the root hairs of leguminous plants. The plant responds by producing nodules to seal off the infection. Inside these swellings, *Rhizobium* cells grow and become pleomorphic symbionts called bacteroids. Bacteroids have characteristic morphology and they fix atmospheric nitrogen.

Among nitrogen-fixing prokaryotes, aerobic, microaerophilic and anaerobic microorganisms can be identified. Since the nitrogenase enzyme is very sensitive to the presence of oxygen, the intracellular oxygen partial pressure should be reduced in an aerobic/oxic environment. The nodules contain leg-hemoglobin, which is responsible for the suitably low oxygen tension necessary for bacteroids (Fig. 46).

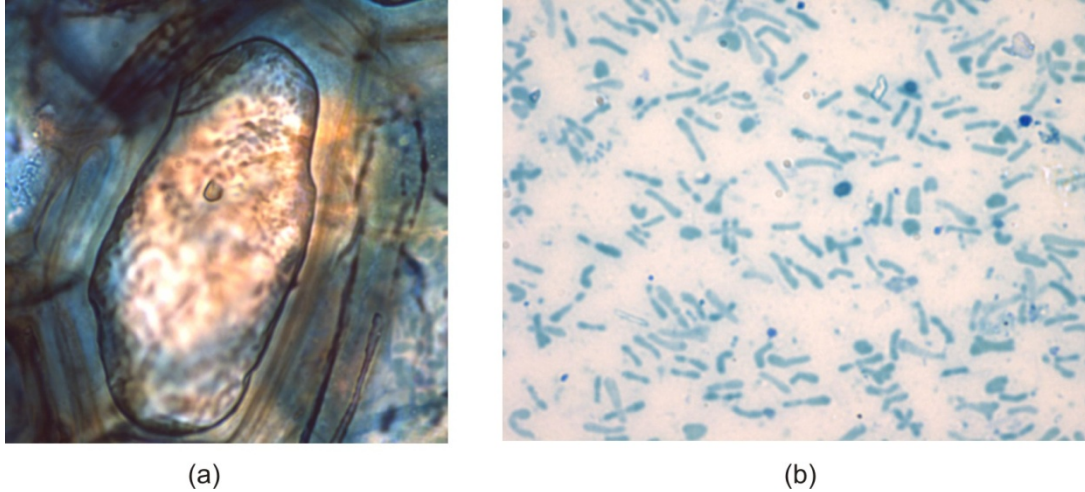

Fig. 46. Morphology of bacteroids. (a) Bacteroid-containing plant cell inside the nodule. (b) Bacteroids stained with methylene-blue.

EXERCISE 90: EXAMINATION OF BACTEROID MORPHOLOGY

Object of study, test organisms:

bacteroids in the nodule of leguminous plants

Materials and equipment:

root sample (leguminous plant)
scalpel
forceps
glass slide
methylene-blue solution
Bunsen burner
light microscope

Practise:

1. Cut a nodule off the washed leguminous root sample using forceps and a scalpel (The active nodules have a slightly pink colour, since they contain leg-hemoglobin).
2. Gently press the nodules between two glass slides.
3. Air dry and heat fix the smear, and then stain the smear with methylene blue (see EXERCISE 36).
4. Observe the large, irregular rods of the bacteroids under the microscope and draw their morphology.

EXERCISE 91: STUDY OF CYANOBACTERIA WITH HETEROCYSTES OCCURRING IN NATURAL WATER SAMPLES

In some of the free living cyanobacteria (Fig. 47) (e.g. *Cylindrospermopsis raciborskii*, *Nostoc punctiforme*), nitrogen fixation takes place in thick-walled, specialised nitrogen-fixing cells called heterocysts.

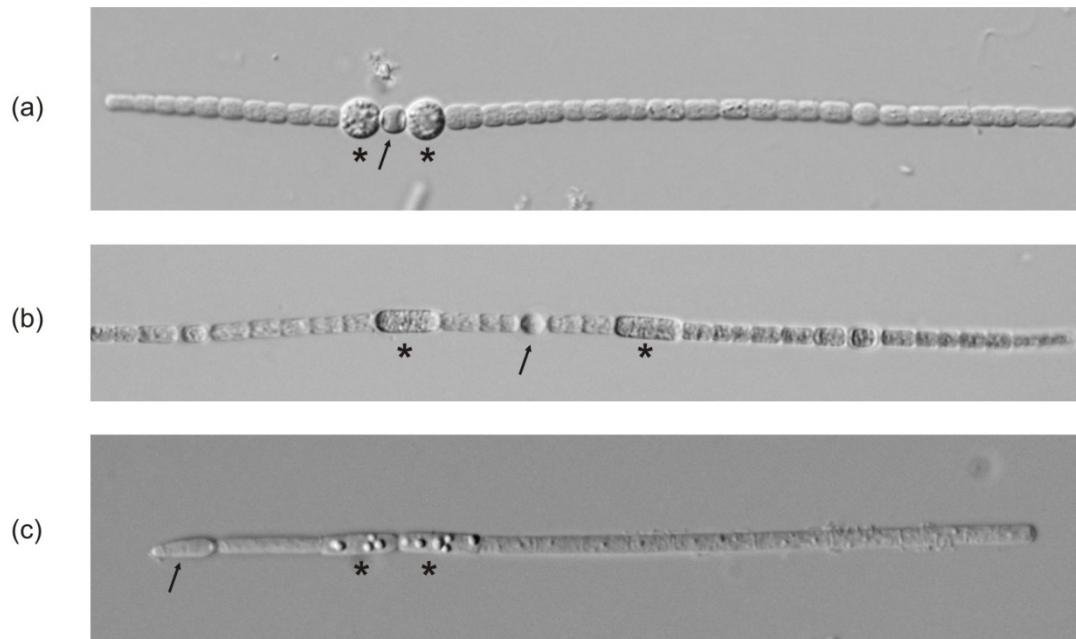

Fig. 47. Filamentous nitrogen-fixing cyanobacteria from lake water samples. (a) *Anabaena* sp. (b) *Aphanizomenon* sp. (c) *Cylindrospermopsis raciborskii* (Micrographs by Lajos Vörös and Boglárka Somogyi). Arrows indicate the heterocysts, while star indicates akinete.

Object of study, test organisms:

Free-living cyanobacteria

Materials and equipment:

water sample (e.g. lake, aquarium, etc.)
Pasteur pipette
glass slide
cover slip
microscope

Practise:

1. Put a drop of water sample onto a slide and cover with a cover slip.
2. Check and draw the morphology of different cyanobacteria (unicellular, filamentous, etc.) and try to search for heterocysts in the microscopic field.

EXERCISE 92: DEMONSTRATION OF AMMONIFICATION

During ammonification, some organic nitrogen compounds (amino acids, carbamide, etc.) are deaminated to form ammonium ions and as a function of pH, ammonia is released into the environment. For such deamination reactions, bacteria use many enzymes with different substrate specificity (one way of getting rid of excess organic nitrogen). The remaining part of the molecule can be used for e.g. energy generation. Within the nitrogen cycle, ammonification is considered as a mineralisation step. Ammonia and ammonium ion can be taken up and used for amino acid synthesis by other organisms (plants, microbes) or it can be absorbed in the soil by humus-colloids (Fig. 45).

Object of study, test organisms:

unknown bacterial slant culture

Materials and equipment:

peptone broth (see Appendix)
 urea broth (see Appendix)
 inoculating loop
 sterile distilled water in test tubes
 pipette, sterile pipette tips
 Bunsen burner
 incubator
 Nessler's reagent (see Appendix)

Practise:

1. Make a suspension from the unknown bacterial strain in sterile distilled water.
2. Inoculate the peptone/urea broth tubes with 0.1-0.1 mL bacterial suspension.
3. Incubate the tubes at 28°C for one week.
4. The presence of accumulated ammonia in the broth can be demonstrated by adding a few drops of Nessler's reagent (an alkaline solution of potassium-tetraiodo-mercurate). Weak positive reaction yields a yellow colour, strong positive reaction results in a yellowish brown colour and precipitation (basic mercury-amido-iodide).

EXERCISE 93: DEMONSTRATION OF NITRIFICATION AND INHIBITION OF NITRIFICATION

Under aerobic conditions, ammonia does not accumulate in the soil or water. Beside the assimilation of ammonia (for e.g. amino acid synthesis), certain bacteria can gain energy by utilizing ammonia as electron donor (as well as generating reducing potential) in dissimilative processes. Nitrification is carried out by chemolithoautotrophic bacteria (e.g. *Nitrosomonas* and *Nitrobacter*) and different heterotrophic microorganisms. Nitrate can be taken up by plants more easily than ammonia, however, due to its higher degree of mobility, nitrate can be leached out from soils, deteriorating the quality of both surface and underground waters.

Nitrification is a two-step biological process (**Table 9**).

Table 9. Steps of nitrification

Name of process	Reaction	Typical bacterial genus
Ammonia oxidation	$NH_4^+ + 1,5 O_2 \rightarrow NO_2^- + H_2O + 2 H^+$	Nitrosomonas, Nitrosospira
Nitrite oxidation	$NO_2^- + 0,5 O_2 \rightarrow NO_3^-$	Nitrobacter, Nitrospira

The key enzyme of ammonia-oxidation is ammonia monooxygenase (AMO), which is usually active in the presence of copper ions. Allyl-thiourea (ATU) is a selective copper-chelator compound, thus ATU can inhibit the ammonia monooxygenase enzyme.

Object of study, test organisms:

nitrifying bacteria in soil

Materials and equipment:

ammonia broth (see Appendix)
 nitrite broth (see Appendix)
 soil sample
 sterile distilled water in test tubes
 pipette, sterile pipette tips
 vortex mixer
 allyl-thiourea (ATU)
 laboratory scales
 incubator
 empty test tubes
 Griess-Ilosvay reagent (see Appendix)

Nessler's reagent (see Appendix)
Zn powder

Practise:

1. Add ATU at a final concentration of 5 mg/L to half of the nutrient tubes containing ammonia and nitrite broth.
2. Inoculate the media with 0.5 mL soil suspension.
3. Incubate the samples at 28°C for one week.
4. Transfer 1-1 mL of each broth to a new, empty test tube. Add some drops of Griess-Ilosvay-reagent to the tubes (nitrite A and B reagent). Mix the contents of the tubes. The presence of nitrite in the broth is demonstrated by a cherry red colour within 30 sec.
5. There are two possibilities if there is no red coloration: either ammonia oxidation has not taken place (effect of the inhibitor or the absence of ammonia-oxidizing bacteria), or nitrite was completely oxidised to nitrate. To distinguish between these two options, add a small amount of zinc powder to the test tubes (max. 5 mg/mL). If nitrate has been formed during nitrification, zinc will reduce it back to nitrite, and the Griess-Ilosvay-reagent will turn red.
6. If there is still no colour change after the addition of zinc to the ammonium broth, add Nessler's reagent to the remaining broth. If a yellowish brown colour develops, it indicates that ammonium ions remain in the broth.
7. Summarise your results in a table form indicating the compound detected and the type of oxidation in each media (see Appendix).

EXERCISE 94: DEMONSTRATION OF DISSIMILATORY NITRATE REDUCTION

During the dissimilatory nitrate reduction, the end products are nitrite, dinitrogen-oxide and nitrogen gas. The process is anaerobic and takes place in compacted environments, such as water-saturated soils, river or lake sediments, inside the gastrointestinal tract of higher organisms. When a gaseous substance (N_2O , NO , N_2) is produced, the process is called denitrification. This process plays a very important role in the nitrogen equilibrium and self-purification of soil and water. From a biochemical point of view, this process is nitrate reduction: the utilisation of nitrate as electron acceptor for the biological oxidation of different organic and inorganic (e.g. H_2S) substances.

Object of study, test organisms:

nitrate-reducing and denitrifying bacteria of soil
unknown bacterial strain slant culture

Materials and equipment:

soil/sediment sample
nitrate broth containing Durham tubes (see Appendix)
sterile distilled water in test tubes
pipette, sterile pipette tips
vortex mixer
incubator
empty test tubes
Griess-Ilosvay reagent (see Appendix)
Nessler's reagent (see Appendix)
Zn powder

Practise:

1. Prepare suspension from the soil/sediment sample as well as from bacterial cultures in sterile distilled water.
2. Inoculate the nitrate media with 0.5 mL soil/sediment/bacterium suspension.
3. Incubate the samples at 28°C for one week.

4. Evaluate the results for the presence of the following products (see also EXERCISE 93):

Nitrite (NO ₂ ⁻):	Griess-Ilosvay reagent
Nitrogen gas (N ₂):	Bubbles inside the Durham tubes
Ammonia:	Nessler's reagent

8.4. Examination of microorganisms participating in the sulphur cycle

The microbial sulphur transformation processes are more complex than those of nitrogen, as sulphur can occur in more oxidation states and the transformations between a number of different sulphur forms takes place abiotically as well (Fig. 48).

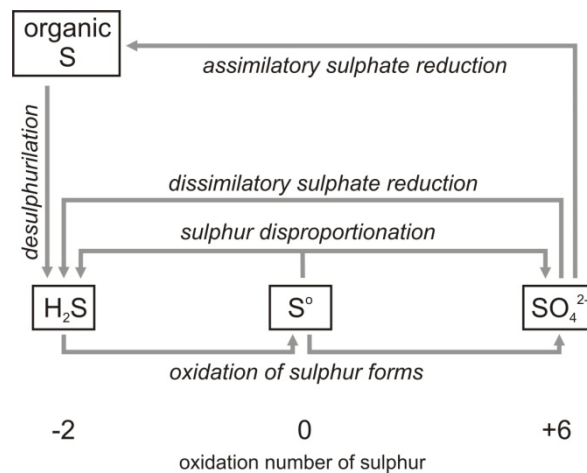

Fig. 48. The sulphur cycle. Sulphur-containing compounds are shown in rectangles. The different sulphur transformation processes are indicated with arrows (only four main processes are shown).

EXERCISE 95: ESTIMATING THE NUMBER OF SULPHATE REDUCING BACTERIA (SRB) BY MPN METHOD

The role of anoxygenic phototrophic bacteria in the sulphur cycle (see Winogradsky column) has been described previously (see EXERCISE 26). Therefore, the role of sulphate reducing bacteria (SRB) is discussed in this section in more detail.

If sulphate ions are present in an anaerobic environment, fermentation end products can be further transformed with the involvement of SRB. SRB form a specialised group, which grows under anaerobic conditions and obtains energy from the oxidation of various organic compounds using especially sulphate as a terminal electron acceptor. The metabolic end product of the (dissimilatory) sulphate reduction is sulphide ion and, depending on the pH, hydrogen sulphide (H₂S). The typical substrates (electron donors) of SRB involve simple, short-chain carbon compounds.

SRB are more "restricted" than fermentative microorganisms in their spectrum of utilised organic compounds. Most of the fermentative microorganisms are able to transform very complex organic compounds and polymers, while the substrates for SRB are mainly various low molecular weight organic compounds, the final products of acetogenic fermentation (e.g. lactate, acetate, propionate). Therefore, SRB depend on acid producing bacteria that provide them with electron donors.

SRB form a polyphyletic group and can be divided into four major taxon clusters: Gram-negative mesophilic SRB, Gram-positive spore-forming SRB, thermophilic SRB and thermophilic sulphate reducing Archaea. According to their metabolic characteristics, SRB can be divided in two main categories: incomplete oxidisers, those that oxidise organic substrates only to acetate (e.g. *Desulfovibrio*, *Desulfotomaculum*, *Desulfobulbus*), and complete oxidisers,

those that oxidise organic substrates to CO₂ (e.g. *Desulfobacter*, *Desulfococcus*, *Desulfosarcina*). Some members of both groups show hydrogenase activity, thus are also able to use hydrogen as an electron donor.

SRB have economic importance since they play an important role in metal corrosion (their activity can cause the corrosion of gasoline or gas pipes) and in wastewater treatment processes (part of the biofilm-forming community). Therefore, it is important to study their distribution within a sample.

Postgate's Medium B (PMB) is a differential culture broth, which is suitable for the cultivation of the members of the two most common SRB genera (*Desulfovibrio* and *Desulfotomaculum*). The differentiating effect of this medium is based on the appearance of black iron sulphide precipitation due to bacterial sulphate reduction.

Object of study, test organisms:

sulphate reducing bacteria

Materials and equipment:

lake sediment sample from 2-5 cm layer below the surface, or sample from the Winogradsky column
Postgate's Medium B (PMB) broth (see Appendix)
laboratory scales
sterile test tubes
pipette, sterile pipette tips
vortex mixer
microtiter plate
anaerobic chamber

Practice:

1. Measure 3.0 g sediment sample into 27 mL PMB broth. Homogenise the suspension for 5-10 minutes using a vortex mixer.
2. Pipette 0.3 mL of the obtained suspension into a test tube containing 2.7 mL PMB broth (label the degree of the dilution on the test tube).
3. Homogenise the further diluted sample and pipette another 0.3 mL of the obtained suspension into another test tube containing 2.7 mL PMB broth. Repeat the steps of the dilution until a six-member dilution series is obtained (label the degree of the dilution on each test tube).
4. Pipette 0.3 mL suspension from each member of the dilution series (including the first dilution) into the wells of a 96-well microtiter plate in five replicates (5 test-tube MPN method).
5. Place the microtiter plates inside the anaerobic chamber and incubate at 30°C for 2 weeks.
6. The number of SRB is estimated by the colour change of the PMB broth (black precipitate of iron sulphide). Count the positive wells (black coloured) on the plate, and by knowing the degree of the dilution, transform it using McCrady tables (see Appendix) to obtain the MPN value (Fig. 17).

Chapter 9. FERMENTATION PROCESSES IN BIOTECHNOLOGY

Biotechnology in the classical sense is defined as an industrial production technique, where living organisms or their components (e.g. enzymes) carry out the production of the required material. Technologies based on “microbial fermentations” can be defined as traditional biotechnological techniques. In this case, microorganisms in an artificial environment (in fermentors under aerobic or anaerobic conditions) produce their primary or secondary metabolites, such as antibiotics, citric acid and alcohols. Nowadays, the use of recombinant DNA techniques made the production of several compounds (e.g. insulin, growth factors, interferon) possible by genetically modified organisms (Table 10). In addition to microorganisms, these organisms can be plants and animals or their cell cultures.

Table 10. Characteristic biotechnological processes with microorganisms as producers

Metabolites	Microorganisms
Products intended for industrial use	
Ethanol (from glucose)	<i>Saccharomyces cerevisiae</i>
Ethanol (from lactose)	<i>Kluyveromyces fragilis</i>
Acetone and butanol	<i>Clostridium acetobutylicum</i>
2,3-butanediol	<i>Enterobacter, Serratia</i> spp.
Enzymes (amylase, protease etc.)	<i>Aspergillus, Bacillus, Mucor, Trichoderma</i> spp.
Products intended for agricultural use	
Gibberellins	<i>Gibberella fujikuroi</i>
Food additives	
Amino acids (lysine etc.)	<i>Corynebacterium glutamicum</i>
Organic acids (citric acid)	<i>Aspergillus niger</i>
Nucleotides	<i>Corynebacterium glutamicum</i>
Vitamins	<i>Ashbya, Eremothecium, Blakeslea</i> spp.
Polysaccharides	<i>Xanthomonas</i> spp.
Products intended for medical use	
Antibiotics	<i>Penicillium, Streptomyces, Bacillus</i> spp.
Alkaloids	<i>Claviceps purpurea</i>
Steroids	<i>Rhizopus, Arthrobacter</i> spp.
Insulin, human growth factor, interferon, somatostatin, etc.	<i>Escherichia coli, Saccharomyces cerevisiae</i> and other organisms (recombinant DNA techniques)
Products used as fuels	
Hydrogen	photosynthetic microorganisms
Methane	<i>Methanobacterium</i> spp.
Ethanol	<i>Zymomonas, Thermoanaerobacter</i> spp.

The primary metabolites are essential for cellular life and reproduction and are synthesised during the growth phase (trophophase). These substances include: amino acids, nucleotides, vitamins and fermentation end products (e.g. ethanol and organic acids). The secondary metabolites however are produced in the idiophase, following the growth phase. Due to the accumulation of toxic substances and the lack of nutrients, oxygen or other essential compounds needed for the synthesis of cell components, growth and replication stops and secondary metabolites accumulate

in the nutrient medium. These substances (e.g. antibiotics, mycotoxins) differ in their chemical structure and physiological impact.

EXERCISE 96: APPLYING IMMOBILISED CELL TECHNIQUE IN ETHANOL FERMENTATION

Ethanol production in the industry is carried out by *Saccharomyces cerevisiae* cells. The advantages of immobilised cell techniques are: higher cell density, microbial biomass can be reused multiple times, continuous fermentation process is achievable, there is less possibility of contamination during the process and the product can be easily purified after fermentation.

There are three major types of immobilised cell techniques: binding to carriers, the cross-linking method and the capturing method (Fig. 49). In the first case, cells or enzymes are bound to a solid carrier through adsorption, ionic or covalent bonding. Carriers can be water insoluble polysaccharides (e.g. cellulose, dextran, agarose), proteins (e.g. gelatine, albumin), synthetic polymers (e.g. ion exchange resins, polyvinyl chloride) and inorganic compounds (e.g. quartz). In the cross-linking method, reagents with two or more functional groups (e.g. glutaraldehyde) react with the cells. In the capturing/ inclusion method, cells are enclosed in a polymer material (e.g. alginate, polyacrylamide).

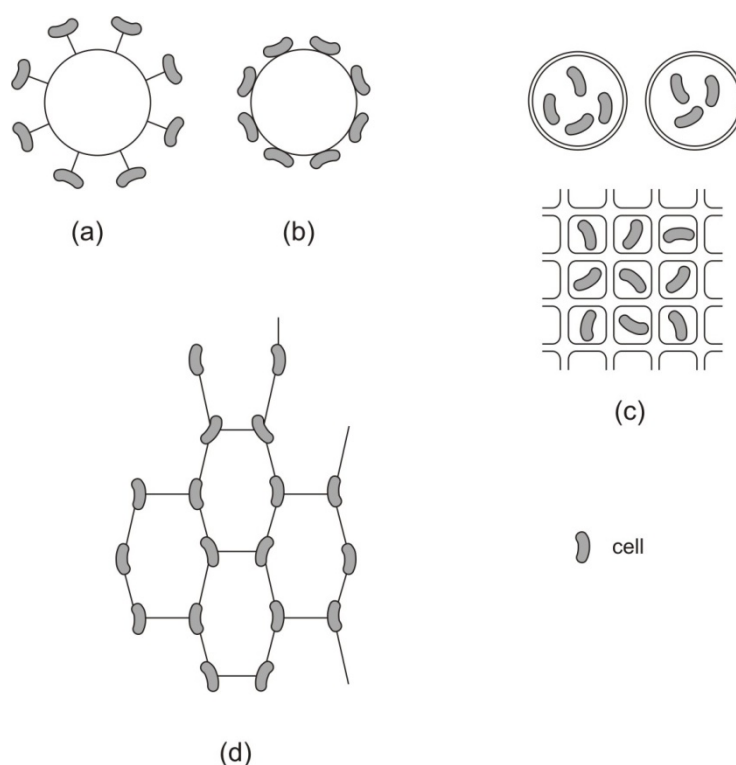

Fig. 49. Immobilised cell technique. Binding to a carrier: (a) through covalent bonding (b) through adsorption. (c) Capturing/inclusion method. (d) Cross-linking method.

Object of study, test organisms:

Saccharomyces cerevisiae cell suspension (about 25 g wet cell biomass)

Materials and equipment:

- pipettes, sterile pipette tips
- glucose broth (see Appendix)
- malt extract broth (see Appendix)
- 50 mL 4 w/w% alginate solution
- 50 mL 0.05M CaCl₂ solution (pH 6-8)
- sterile Pasteur pipette
- K-dichromate solution
- test tubes

37°C water bath
incubator

Practise:

1. Mix 50 mL *Saccharomyces cerevisiae* cell suspension with 4% alginate solution under sterile conditions.
2. Drip the volume of this mixture into 50 mL 0.15M CaCl₂ solution at room temperature. Drops of alginate will form small balls (capturing *S. cerevisiae* cells inside) in the CaCl₂ solution.
3. Let it solidify for 1 hour at 20-22°C, and then stabilise with overnight incubation at 4°C.
4. Remove the CaCl₂ solution and add glucose/malt extract broth the next morning.
5. Incubate at 28°C for one week without agitation. Check the clarity of the broth.
6. The produced alcohol can be detected with diluted (H₂SO₄) acidified potassium dichromate: add approximately 2 mL of fermentation broth to a test tube and add 6-8 drops of potassium dichromate solution into the tube.
7. Evaluate your data: in the case of positive reaction, the potassium dichromate oxidises alcohol to carbonic acid (through aldehyde), while the oxidation state of chromium is reduced from +6 (brown colour) to +3 (green colour). Examine the colour change of the solution.
8. Compare the results of the two different fermentation media.

EXERCISE 97: CITRIC ACID PRODUCTION IN SHAKEN CULTURE

Nowadays, citric acid (2-hydroxy-propane-1,2,3-tricarboxylic acid) is produced microbiologically by *Aspergillus niger* and *Aspergillus wentii*. The most important carbon source for citric acid production is glucose. Some of the glucose is used for mycelium growth in the trophophase, while glucose is used for citric acid production during the idiophase.

Object of study, test organisms:

Aspergillus niger on Petri plates

Materials and equipment:

test tubes with sterile distilled water
pipette, sterile pipette tips
Bürker chamber
inoculating loop
broth for citric acid production (see Appendix)
shaker incubator
incubator
thin layer chromatography (TLC) plates (silicagel, 5x4 cm in size)
microcapillary
glass developing tank for running TLC
forceps
hairdryer
solvent mixture (benzene:methanol:acetic acid in ratio 45:8:4)
1% citric acid solution
Schweppe's reagent (see Appendix)
laboratory oven (125°C)

Practise:

1. Transfer *Aspergillus niger* spores from an agar slant into two tubes containing sterile distilled water using an inoculating loop.

2. Using a Bürker chamber, set the spore concentration of the suspensions to 20,000 and 80,000 spores/mL, respectively (see EXERCISE 13).
3. Add 1 mL of each spore suspension into separate Erlenmeyer flasks containing 50 mL nutrient media for citric acid production.
4. Shake the flasks at 37°C for one week at 270 rpm.
5. Demonstrate the citric acid production by thin layer chromatography (TLC): spot the plate with samples and 1% citric acid as control using a microcapillary. Put the TLC plate into the glass developing tank containing the solvent mixture. Run it four times and dry the plate with a hairdryer after each run. Spray Schwebpe's reagent onto the TLC plate and incubate at 125°C in an oven for 5 minutes. Citric acid will appear as a brown spot on the TLC plate.
6. Compare the results of the two different spore concentrations.

Chapter 10. DATA ANALYSIS – TAXOMETRICS

During the analysis of an unknown bacterial strain, 40-50 or even more (few hundred) phenotypical characters are determined. This amount of data is unmanageable during species identification with the use of identification keys. In such a case, data should be collected onto a spreadsheet (optionally, with the same data of type strains). Using special similarity grouping-based statistical software (cluster analysis), automatic identification can be reached (if type strains cluster into groups). Such phenotypic character-based identification systems are called taxometrics (numerical taxonomy).

In the case of cluster analysis (Fig. 50), the above-mentioned data matrix is prepared first, where each column corresponds to one strain, and each row corresponds to the results of one experiment. Strains are also called OTUs (operational taxonomic units) or objects, and the characters are called variables. It is assumed that the phenotypical (e.g. morphological, biochemical, physiological) characters of the strains are more or less stable, they are specific for each bacterial species, and each character has the same weight. These characters are assigned as binary variables to the strains, therefore the result of each test should be converted into a yes-no (1-0) form (e.g. whether the strain releases ammonia from peptone, which can be identified with the Nessler's reagent). However, some of the variables are quantitative, which cannot be coded directly in a binary way (e.g. cell size). During cluster analysis, these variables should be converted to binary forms as well (e.g. whether the length of the cell is shorter than 2.3 μm).

Subsequently, a similarity matrix is computed from the data matrix on the basis of the pairwise similarities among each OTU using e.g. the Simple Matching or the Jaccard coefficient.

Finally, a hierarchical clustering is performed using the similarity matrix with the help of the UPGMA (Unweighted Pair Group Method of Averages) or single linkage algorithm. The result is visualised in a dendrogram, which reveals the similarity among the strains. If the data from known strains (e.g. type strains) are also involved in the analysis, the unknown strains could be identified automatically. Data from known strains can be found e.g. in the Bergey's Manual of Systematic Bacteriology, but their phenotypic characters should also be determined in parallel with testing the unknown strains.

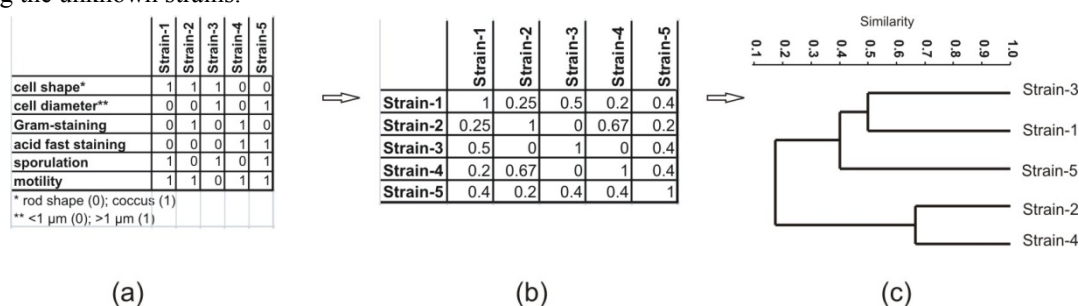

Fig. 50. Cluster analysis of bacterial strains based on phenotypic characters. (a) Spreadsheet containing phenotypic characters of each investigated strain. (b) Similarity matrix of the strains based on Jaccard index. (c) Hierarchical clustering with UPGMA algorithm.

EXERCISE 98: CLUSTER ANALYSIS BASED ON THE PHENOTYPICAL CHARACTERS OF UNKNOWN BACTERIAL STRAINS

Object of study, test organisms

clustering and identifying bacterial strains using phenotypic data

Materials and equipment:

test results of unknown bacterial strains in spreadsheet form
test results of known bacterial strains in spreadsheet form
computer with installed Excel and statistical (SPSS, Syn-Tax, Past) softwares

Practise:

1. Prepare the data matrix from the test results of the unknown and known bacterial strains in spreadsheet software (e.g. Excel). Code each variable in a binary form.
2. Start the statistical software. (The use of the Past software is described in this text; <http://folk.uio.no/ohammer/past/>)
3. In Past, check the “Edit labels” box above the table, insert the data matrix from the spreadsheet software, and uncheck the “Edit labels” box.
4. Select the entire table and transpose it (Upper menu: Edit>Transpose). This is important, as when creating a dendrogram, Past requires the objects in rows and the variables in columns.
5. Select the entire table again and construct a dendrogram (Upper menu: Multivar>Cluster analysis) using the “paired group” algorithm – this corresponds to the UPGMA and Jaccard coefficient.
6. Find the known strains that are most similar to the unknown strains on the dendrogram. Evaluate phena (i.e. phenotypic clusters), etc.

Chapter 11. BASIC ALGOLOGICAL METHODS

Excessive eutrophication severely changes the original aquatic community. It is usually unwanted from a human point of view, since it prevents most uses (i.e. bathing, drinking water production). In other words, the quick increase of trophic status indicates the decrease of water quality. Therefore, e.g. the quality requirements of natural spas include the determination of the chlorophyll-a content [Hungarian Government STATUTE 78/2008. (VI.3.)].

In a biological sense, water contains four forms of soluble or particulate material: inorganic nutrients, organic nutrients, toxic and neutral substances. The quality of natural surface waters could be monitored by the determination of parameters used in biological water quality assessment (halobity, trophity, saprobity and toxicity status), which usually correlate with each other. The Water Framework Directive (WFD) of the European Union regulates the evaluation of the ecological status of surface waters. One of the five ecological groups that should be monitored according to the WFD is the planktonic photosynthetic organisms, the so-called phytoplankton.

EXERCISE 99: DETERMINATION OF CHLOROPHYLL-A CONTENT IN PHYTOPLANKTON SAMPLES BY METHANOL EXTRACTION

Currently, the standard method applied for the determination of the chlorophyll-a content of phytoplankton (MSZ ISO 10260) is based on ethanol extraction. This method has several biases, therefore in this practical, a more exact methanol extraction technique is described.

Object of study, test organisms:

water sample (e.g. lake, river, aquarium), planktonic photosynthetic organisms

Materials and equipment:

absolute methanol
glass fibre filter, paper filter
pipette, sterile pipette tips
funnel
measuring cylinder
vacuum filtration equipment
test tubes
test tube closed with glass-joint air leak capillary tube
wooden test tube clamps
water bath
plastic gloves
spectrophotometer with cuvettes

Practise:

1. Filter 500 mL water sample through a glass fibre filter until there is no excess water on the filter.
2. Remove the air leak capillary tube and pipette 10 mL methanol into the test tube. Cut the filter into small pieces and put into the methanol.
3. Close the test tube with the air leak capillary tube and heat for 3 minutes in a water bath at 74°C.
4. Pipette an additional 10 mL methanol into the tube. Take plastic gloves, close the tube with your finger, and mix thoroughly.
5. Filter the extract through a paper filter, load the filtrate into a cuvette. Clean the outer surface of the cuvette from droplets and contaminations.

6. Measure the extinction of the extract at 653, 666 and 750 nm, respectively. Use methanol as a control for calibration.
7. Calculate chlorophyll-a concentration using the following formulas.
Chlorophyll-a concentration given in $\mu\text{g/L}$ is: $m \times Ca \times 103 \text{ M}^{-1}$;
where $Ca = 17.12 \times E_{666} - 8.68 \times E_{653}$;
“m” is the volume of methanol used for extraction (mL); “M” is the volume of water filtered (mL)
 E_{666} is the extinction value measured at 666 nm minus the value measured at 750 nm;
 E_{653} is the extinction value measured at 653 nm minus the value measured at 750 nm.

EXERCISE 100: DIATOM PREPARATION FOR LIGHT MICROSCOPY

Another one of the five groups to be monitored according to the WFD is a group of surface-attached microscopic organisms: benthic diatoms (in other words, phytobenthos). Taxonomic identification of diatoms is mainly based on the structure of their unique silica-based cell wall, the frustule that should be visualised during the identification process. A preparation for light microscopic investigations could be made with the complete destruction of organic cell material.

Object of study, test organisms:

biofilm sample, surface-attached diatoms

Materials and equipment:

concentrated hydrogen peroxide
Naphrax synthetic mounting medium (Brunel Microscopes Ltd)
glass slides and cover slips
toluene
forceps
glass dropper dispenser
plastic gloves
toothpick
hot-plate
light microscope

Practise:

1. Put a single drop of sample (from the sedimentary phase) to a cover slip and remove its water content with a short incubation on a hot-plate.
2. Drop concentrated hydrogen peroxide onto the sample and dry with heating as described above. Repeat this step.
3. Put a small amount of Naphrax mounting medium onto a microscope slide with a toothpick.
4. Put the cover slip (with the sample facing down) onto the Naphrax droplet, and push the cover slip gently with your finger to the microscopic slide.
5. Remove the solvent from the mounting medium with the heating procedure described above. If the Naphrax starts to boil with fine bubbles, remove the slide from the hot-plate and wait until boiling stops. Repeat boiling.
6. Remove the slide with the boiling Naphrax from the hot-plate, remove the fine bubbles with a gentle push using the rounded part of the forceps, and push the cover slip entirely to the surface of the slide. (This step can only be done with a hot mounting medium, therefore should be performed quickly.) Let the slide cool (at least for half an hour).
7. Remove the spare mounting medium surrounding the cover slip with toluene (avoid skidding of the cover slip).
8. Observe the morphology of diatoms in the sample with a microscope (100 \times magnification, immersion objective). Try to identify different taxa using adequate identification keys.

Chapter 12. SUPPLEMENTARY MATERIAL

12.1 Supplementary exercises

SUPPLEMENTARY EXERCISE S1: AMPLIFICATION OF THE 16S rDNA WITH PCR FROM ARCHAEA

Archaea are one of the three domains of life, a lineage with prokaryotic cell morphology like members of the domain Bacteria. Cultivation of these microorganisms is usually more difficult when compared to Bacteria, and most cultivated Archaea are extremophiles (e.g. halophilic and thermophilic). On the other hand, recent results have proven that members of the domain Archaea are present in huge numbers in many environments and these bacteria are relevant mediators of various nutrient cycling processes.

Object of study, test organisms:

genomic DNA extracted from an environmental sample or from archaeal strains

Materials and equipment:

micropipettes, sterile pipette tips
microcentrifuge and PCR tubes
microcentrifuge
microcentrifuge tube rack
10× PCR buffer
25 mM MgCl₂ solution
1 mM dNTP mix
forward and reverse primers:
A344f primer: 5' ACG GGG TGC AGC AGG CGC GA 3'
A934r primer: 5' GTG CTC CCC CGC CAA TTC CT 3'
1 U/μL *Taq* polymerase enzyme
dH₂O [DEPC(diethyl pyrocarbonate)-treated distilled water]
vortex mixer
thermocycler
laboratory scales
250 mL flask
electrophoresis system
agarose
10× TBE solution (see Appendix)
measuring cylinder
DNA stain
loading buffer (see Appendix)
DNA ladder (e.g. pUC Mix, Marker 8, Fig. 39)

Practise:

1. Let frozen DNA samples and PCR reagents thaw at room temperature.
2. Label a 1.5 mL microcentrifuge tube (this will be used for preliminary mixing of the master mix) and some PCR tubes (the amount is determined by the number of DNA samples plus two additional tubes for the positive and negative controls).
3. Make a preliminary mix using: 2.5 μL 10× PCR buffer, 1.5 μL MgCl₂, 5.0 μL dNTP mix, 0.25 μL forward primer, 0.25 μL reverse primer, 1.0 μL DNA sample, 0.5 μL *Taq* polymerase enzyme filled up to a final volume of 25 μL with dH₂O per reaction in a 1.5 mL microcentrifuge tube by multiplying the above amounts with the

number of DNA samples plus three (for controls and pipetting errors; see Appendix). Do not add DNA samples and enzyme to the master mix!

4. Pipette 23.5 μL master mix into each labelled PCR tube, and add 1.0 μL DNA sample to the appropriate tubes. Do not add DNA to the negative control sample, but add DNA, which had been amplified successfully in a previous PCR, to the positive control sample. Vortex the tubes gently, and spin them quickly to collect the liquid on the bottom of the tubes.
5. Put all PCR tubes into the thermocycler and start the reaction with the following parameters: initial denaturation at 98°C for 5 min, followed by 94°C for 10 s, 20 cycles (denaturation at 94°C for 30 s, annealing at 60°C for 30 s, decreasing with 0.5°C in each cycle, extension at 72°C for 1 min), 15 cycles (denaturation at 94°C for 30 s, annealing at 50°C for 30 s, extension at 72°C for 1 min) and a final extension at 72°C for 10 min. Stop reaction at the '94°C for 10 s' step, and add 0.5 μL *Taq* polymerase enzyme to each tube. This is required, since the half-life of the enzyme at 98°C is very short, and the addition of the enzyme directly to the master mix would result in the inactivation of a significant amount of the enzyme during the initial denaturation step.
6. Prepare 1 % agarose gel, and check the amount and quality of PCR products (EXERCISE 77, steps 9-12).
7. PCR products can be stored for a few days at 4°C. Long-term storage can be achieved at -20°C.

SUPPLEMENTARY EXERCISE S2: AMPLIFICATION OF THE 16S rDNA WITH PCR FROM CYANOBACTERIA AND EUKARYOTIC PLASTIDS

In the last decades, molecular biological techniques have played a central role in the taxonomic investigation of cyanobacteria and eukaryotic algae. Identification on the basis of classic algological methods is not possible in many cases, because of the lack of distinct morphological characters (e.g. in the case of small coccoid forms) or the phenotypic plasticity present in many taxa (e.g. diverse cell morphologies under different environmental conditions). In molecular investigations, the most intensively studied gene is the small subunit ribosomal RNA gene, the 16S rDNA in the case of cyanobacteria and the 18S rDNA in the case of eukaryotic algae. Due to the sequences of 16S rDNA present in the chloroplast, eukaryotic algae form a monophyletic branch within the phylogenetic tree of cyanobacteria, and therefore the PCR amplification protocol described below is specific both for cyanobacteria and eukaryotic plastids. However, it should be emphasised that an analysis carried out by molecular biological tools must consider the morphological and ecophysiological features of the investigated taxa.

Object of study, test organisms:

genomic DNA extracted from an environmental sample or from cyanobacterial or algal strains

Materials and equipment:

micropipettes, sterile pipette tips
 microcentrifuge and PCR tubes
 microcentrifuge
 microcentrifuge tube rack
 10× PCR buffer
 25 mM MgCl_2 solution
 1 mM dNTP mix
 forward and reverse primers:
 CYA106f primer: 5' CGG ACG GGT GAG TAA CGC GTG A 3'
 CYA781r primer: 5' GAC TAC WGG GGT ATC TAA TCC CWT T 3'
 1 U/ μL *Taq* polymerase enzyme
 dH₂O [DEPC(diethyl pyrocarbonate)-treated distilled water]
 vortex mixer
 thermocycler
 laboratory scales
 250 mL flask
 electrophoresis system
 agarose
 10× TBE solution (see Appendix)

measuring cylinder
DNA stain
loading buffer (see Appendix)
DNA ladder (e.g. pUC Mix, Marker 8, Fig. 39)

Practise:

1. Let frozen DNA samples and PCR reagents thaw at room temperature.
2. Label a 1.5 mL microcentrifuge tube (this will be used for preliminary mixing of the master mix) and some PCR tubes (the amount is determined by the number of DNA samples plus two additional tubes for the positive and negative controls).
3. Make a preliminary mix using: 2.5 μL 10 \times PCR buffer, 2.0 μL MgCl_2 , 5.0 μL dNTP mix, 0.25 μL forward primer, 0.25 μL reverse primer, 1.0 μL DNA sample, 0.5 μL *Taq* polymerase enzyme filled up to a final volume of 25 μL with dH_2O per reaction in a 1.5 mL microcentrifuge tube by multiplying the above amounts with the number of DNA samples plus three (for controls and pipetting errors; see Appendix). Do not add DNA samples and enzyme to the master mix!
4. Pipette 23.5 μL master mix into each labelled PCR tube, and add 1.0 μL DNA sample to the appropriate tubes. Do not add DNA to the negative control sample, but add DNA, which had been amplified successfully in a previous PCR, to the positive control sample. Vortex the tubes gently, and spin them quickly to collect the liquid on the bottom of the tubes.
5. Put all PCR tubes into the thermocycler and start the reaction with the following parameters: initial denaturation at 98 $^\circ\text{C}$ for 5 min, followed by 94 $^\circ\text{C}$ for 10 s, 32 cycles (denaturation at 94 $^\circ\text{C}$ for 30 s, annealing at 60 $^\circ\text{C}$ for 30 s, extension at 72 $^\circ\text{C}$ for 1 min) and a final extension at 72 $^\circ\text{C}$ for 10 min. Stop reaction at the '94 $^\circ\text{C}$ for 10 s' step, and add 0.5 μL *Taq* polymerase enzyme to each tube. This is required, since the half-life of the enzyme at 98 $^\circ\text{C}$ is very short, and the addition of the enzyme directly to the master mix would result in the inactivation of a significant amount of the enzyme during the initial denaturation step.
6. Prepare 1 % agarose gel, and check the amount and quality of PCR products (EXERCISE 77, steps 9-12).
7. PCR products can be stored for a few days at 4 $^\circ\text{C}$. Long-term storage can be achieved at -20 $^\circ\text{C}$.

SUPPLEMENTARY EXERCISE S3: AMPLIFICATION OF THE ITS REGION WITH PCR FROM FUNGI

Conventional techniques applied for the detection and identification of microscopic fungi are similar to the methods applied for bacteria (cultivation and characterization of morphological features) and therefore suffer from the same limitations that lead to problems of identification: e.g. these techniques are time-consuming, physiological variations are observable in many cases due to the different environmental effects, and not every species can be cultivated under the applied condition. Therefore, PCR-based techniques became widely used in the detection and identification of microscopic fungi. For most fungi, the internal transcribed spacer (ITS) within the nuclear ribosomal 18S and 28S rDNA is the appropriate marker for species identification. This "fungal ITS" contains two spacer regions (ITS-1 and ITS-2), which enclose the 5.8S rDNA.

Object of study, test organisms:

genomic DNA extracted from an environmental sample or from fungal strains

Materials and equipment:

micropipettes, sterile pipette tips
microcentrifuge and PCR tubes
microcentrifuge
microcentrifuge tube rack
10 \times PCR buffer
25 mM MgCl_2 solution
1 mM dNTP mix
forward and reverse primers:

ITS1f primer: 5' CTT GGT CAT TTA GAG GAA GTA A 3'
 ITS4 primer: 5' TCC TCC GCT TAT TGA TAT GC 3'
 1 U/ μ L *Taq* polymerase enzyme
 dH₂O [DEPC(diethyl pyrocarbonate)-treated distilled water]
 vortex mixer
 thermocycler
 laboratory scales
 250 mL flask
 electrophoresis system
 agarose
 10 \times TBE solution (see Appendix)
 measuring cylinder
 DNA stain
 loading buffer (see Appendix)
 DNA ladder (e.g. pUC Mix, Marker 8, Fig. 39)

Practise:

1. Let frozen DNA samples and PCR reagents thaw at room temperature.
2. Label a 1.5 mL microcentrifuge tube (this will be used for preliminary mixing of the master mix) and some PCR tubes (the amount is determined by the number of DNA samples plus two additional tubes for the positive and negative controls).
3. Make a preliminary mix using: 2.5 μ L 10 \times PCR buffer, 2.0 μ L MgCl₂, 5.0 μ L dNTP mix, 0.25 μ L forward primer, 0.25 μ L reverse primer, 1.0 μ L DNA sample, 0.5 μ L *Taq* polymerase enzyme filled up to a final volume of 25 μ L with dH₂O per reaction in a 1.5 mL microcentrifuge tube by multiplying the above amounts with the number of DNA samples plus three (for controls and pipetting errors; see Appendix). Do not add DNA samples and enzyme to the master mix!
4. Pipette 23.5 μ L master mix into each labelled PCR tube, and add 1.0 μ L DNA sample to the appropriate tubes. Do not add DNA to the negative control sample, but add DNA, which had been amplified successfully in a previous PCR, to the positive control sample. Vortex the tubes gently, and spin them quickly to collect the liquid on the bottom of the tubes.
5. Put all PCR tubes into the thermocycler and start the reaction with the following parameters: initial denaturation at 98 $^{\circ}$ C for 5 min, followed by 94 $^{\circ}$ C for 10 s, 32 cycles (denaturation at 94 $^{\circ}$ C for 30 s, annealing at 55 $^{\circ}$ C for 30 s, extension at 72 $^{\circ}$ C for 1 min) and a final extension at 72 $^{\circ}$ C for 10 min. Stop reaction at the '94 $^{\circ}$ C for 10 s' step, and add 0.5 μ L *Taq* polymerase enzyme to each tube. This is required, since the half-life of the enzyme at 98 $^{\circ}$ C is very short, and the addition of the enzyme directly to the master mix would result in the inactivation of a significant amount of the enzyme during the initial denaturation step.
6. Prepare 1 % agarose gel, and check the amount and quality of PCR products (EXERCISE 77, steps 9-12).
7. PCR products can be stored for a few days at 4 $^{\circ}$ C. Long-term storage can be achieved at -20 $^{\circ}$ C.

SUPPLEMENTARY EXERCISE S4: AMPLIFICATION OF THE PHYCOCYANIN OPERON (*cpcBA*-IGS) WITH PCR FROM CYANOBACTERIA

Genes that encode phycobilisome proteins, such as phycocyanin, are present only in cyanobacteria and red algae. The most intensively studied region of the phycocyanin operon (*cpcBA*-IGS) contains two genes and a non-coding region of variable size. Since the phycocyanin operon is not present in freshwater eukaryotic algae, community composition of cyanobacteria could be studied in lake, pond or river samples with *cpcBA*-IGS sequence analysis. Beside 16S rDNA, this region is the most widely used phylogenetic marker in identification and diversity studies of small, single-cell freshwater cyanobacteria (e.g. members of the genus *Synechococcus*). Based on the length heterogeneity analysis of the *cpcBA*-IGS region, the diversity of cyanobacterial communities could be studied. However, the real diversity of a community may be underestimated, since sequences with similar amplicon length may be present in different phylogenetic groups.

Object of study, test organisms:

genomic DNA extracted from an environmental sample or from cyanobacterial strains

Materials and equipment:

micropipettes, sterile pipette tips
 microcentrifuge and PCR tubes
 microcentrifuge
 microcentrifuge tube rack
 10× PCR buffer
 25 mM MgCl₂ solution
 1 mM dNTP mix
 forward and reverse primers:
 cpcBF(UFP) primer: 5' TAG TGT AAA ACG ACG GCC AGT TGY YTK CGC GAC ATG GA 3'
 cpcAR (URP) primer: 5' TAG CAG GAA ACA GCT ATG ACG TGG TGT ARG GGA AYT T 3'
 1 U/μL *Taq* polymerase enzyme
 dH₂O [DEPC(diethyl pyrocarbonate)-treated distilled water]
 vortex mixer
 thermocycler
 laboratory scales
 250 mL flask
 electrophoresis system
 agarose
 10× TBE solution (see Appendix)
 measuring cylinder
 DNA stain
 loading buffer (see Appendix)
 DNA ladder (e.g. pUC Mix, Marker 8, Fig. 39)

Practise:

1. Let frozen DNA samples and PCR reagents thaw at room temperature.
2. Label a 1.5 mL microcentrifuge tube (this will be used for preliminary mixing of the master mix) and some PCR tubes (the amount is determined by the number of DNA samples plus two additional tubes for the positive and negative controls).
3. Make a preliminary mix using: 2.5 μL 10× PCR buffer, 2.0 μL MgCl₂, 5.0 μL dNTP mix, 0.25 μL forward primer, 0.25 μL reverse primer, 1.0 μL DNA sample, 0.5 μL *Taq* polymerase enzyme filled up to a final volume of 25 μL with dH₂O per reaction in a 1.5 mL microcentrifuge tube by multiplying the above amounts with the number of DNA samples plus three (for controls and pipetting errors; see Appendix). Do not add DNA samples and enzyme to the master mix!
4. Pipette 23.5 μL master mix into each labelled PCR tube, and add 1.0 μL DNA sample to the appropriate tubes. Do not add DNA to the negative control sample, but add DNA, which had been amplified successfully in a previous PCR, to the positive control sample. Vortex the tubes gently, and spin them quickly to collect the liquid on the bottom of the tubes.
5. Put all PCR tubes into the thermocycler and start the reaction with the following parameters: initial denaturation at 98°C for 5 min, followed by 94°C for 10 s, 32 cycles (denaturation at 94°C for 45 s, annealing at 45°C for 45 s, extension at 72°C for 45 s) and a final extension at 72°C for 10 min. Stop reaction at the '94°C for 10 s' step, and add 0.5 μL *Taq* polymerase enzyme to each tube. This is required, since the half-life of the enzyme at 98°C is very short, and the addition of the enzyme directly to the master mix would result in the inactivation of a significant amount of the enzyme during the initial denaturation step.
6. Prepare 1 % agarose gel, and check the amount and quality of PCR products (EXERCISE 77, steps 9-12).
7. PCR products can be stored for a few days at 4°C. Long-term storage can be achieved at -20°C.

SUPPLEMENTARY EXERCISE S5: AMPLIFICATION OF THE *nifH* GENE WITH PCR FROM NITROGEN-FIXING BACTERIA

In many environments, the forms of available nitrogen limit the growth of microorganisms, therefore the ability of some prokaryotes to fix nitrogen presents a significant ecological advantage to them. One of the most intensively studied gene involved in nitrogen-fixation is *nifH*, which encodes the dinitrogenase reductase enzyme, and probably the most well-known non-cyanobacterial nitrogen-fixing prokaryotes are the members of the genus *Rhizobium* and related genera. These bacteria are originally known as nitrogen-fixing endosymbionts of legume species, although in the last decades the presence of free living rhizobia has been demonstrated from soils, bioreactors, and even from oligotrophic aquatic environments. Such strains may have arisen through the loss of symbiotic plasmids and therefore lack the *nifH* gene.

Object of study, test organisms:

genomic DNA extracted from an environmental sample (e.g. soil) or from bacterial strains

Materials and equipment:

micropipettes, sterile pipette tips
 microcentrifuge and PCR tubes
 microcentrifuge
 microcentrifuge tube rack
 10× PCR buffer
 25 mM MgCl₂ solution
 1 mM dNTP mix
 forward and reverse primers:
 nifH 40f primer: 5' GGN ATC GGC AAG TCS ACS AC 3'
 nifH 817r primer: 5' TCR AMC AGC ATG TCC TCS AGC TC3'
 1 U/μL *Taq* polymerase enzyme
 dH₂O [DEPC(diethyl pyrocarbonate)-treated distilled water]
 vortex mixer
 thermocycler
 laboratory scales
 250 mL flask
 electrophoresis system
 agarose
 10× TBE solution (see Appendix)
 measuring cylinder
 DNA stain
 loading buffer (see Appendix)
 DNA ladder (e.g. pUC Mix, Marker 8, Fig. 39)

Practise:

1. Let frozen DNA samples and PCR reagents thaw at room temperature.
2. Label a 1.5 mL microcentrifuge tube (this will be used for preliminary mixing of the master mix) and some PCR tubes (the amount is determined by the number of DNA samples plus two additional tubes for the positive and negative controls).
3. Make a preliminary mix using: 2.5 μL 10× PCR buffer, 2.0μL MgCl₂, 5.0 μL dNTP mix, 0.25 μL forward primer, 0.25 μL reverse primer, 1.0 μL DNA sample, 0.5 μL *Taq* polymerase enzyme filled up to a final volume of 25 μL with dH₂O per reaction in a 1.5 mL microcentrifuge tube by multiplying the above amounts with the number of DNA samples plus three (for controls and pipetting errors; see Appendix). Do not add DNA samples and enzyme to the master mix!
4. Pipette 23.5 μL master mix into each labelled PCR tube, and add 1.0 μL DNA sample to the appropriate tubes. Do not add DNA to the negative control sample, but add DNA, which had been amplified successfully in a

previous PCR, to the positive control sample. Vortex the tubes gently, and spin them quickly to collect the liquid on the bottom of the tubes.

5. Put all PCR tubes into the thermocycler and start the reaction with the following parameters: initial denaturation at 98°C for 5 min, followed by 94°C for 10 s, 35 cycles (denaturation at 94°C for 30 s, annealing at 50°C for 30 s, extension at 72°C for 1min) and a final extension at 72°C for 10 min. Stop reaction at the '94°C for 10 s' step, and add 0.5 µL *Taq* polymerase enzyme to each tube. This is required, since the half-life of the enzyme at 98°C is very short, and the addition of the enzyme directly to the master mix would result in the inactivation of a significant amount of the enzyme during the initial denaturation step.
6. Prepare 1 % agarose gel, and check the amount and quality of PCR products (EXERCISE 77, steps 9-12).
7. PCR products can be stored for a few days at 4°C. Long-term storage can be achieved at -20°C.

SUPPLEMENTARY EXERCISE S6: AMPLIFICATION OF THE *amoA* GENE WITH PCR FROM AUTO-TROPHIC AMMONIA-OXIDIZING BACTERIA

Another important process in the nitrogen cycle is nitrification, and nitrifying bacteria are widely distributed in aquatic habitats and soils. The first step of this process is catalysed by ammonia-oxidizing bacteria, and the rate limiting step of ammonia-oxidation is carried out by the A subunit of the ammonia monooxygenase enzyme, which is encoded by the *amoA* gene. PCRs specific for this gene are widely used for the functional detection of ammonia-oxidizers.

Object of study, test organisms:

genomic DNA extracted from an environmental sample

Materials and equipment:

micropipettes, sterile pipette tips
 microcentrifuge and PCR tubes
 microcentrifuge
 microcentrifuge tube rack
 10× PCR buffer
 25 mM MgCl₂ solution
 1 mM dNTP mix
 forward and reverse primers:
 amoA-1f primer: 5' GGG GTT TCT ACT GGT GGT 3'
 amoA-2r primer: 5' CCC CTC KGS AAA GCC TTC TTC 3'
 1 U/µL *Taq* polymerase enzyme
 dH₂O [DEPC(diethyl pyrocarbonate)-treated distilled water]
 vortex mixer
 thermocycler
 laboratory scales
 250 mL flask
 electrophoresis system
 agarose
 10× TBE solution (see Appendix)
 measuring cylinder
 DNA stain
 loading buffer (see Appendix)
 DNA ladder (e.g. pUC Mix, Marker 8, Fig. 39)

Practise:

1. Let frozen DNA samples and PCR reagents thaw at room temperature.
2. Label a 1.5 mL microcentrifuge tube (this will be used for preliminary mixing of the master mix) and some PCR tubes (the amount is determined by the number of DNA samples plus two additional tubes for the positive and negative controls).

3. Make a preliminary mix using: 2.5 μL 10 \times PCR buffer, 2.0 μL MgCl_2 , 5.0 μL dNTP mix, 0.25 μL forward primer, 0.25 μL reverse primer, 1.0 μL DNA sample, 0.5 μL *Taq* polymerase enzyme filled up to a final volume of 25 μL with dH_2O per reaction in a 1.5 mL microcentrifuge tube by multiplying the above amounts with the number of DNA samples plus three (for controls and pipetting errors; see Appendix). Do not add DNA samples and enzyme to the master mix!
4. Pipette 23.5 μL master mix into each labelled PCR tube, and add 1.0 μL DNA sample to the appropriate tubes. Do not add DNA to the negative control sample, but add DNA, which had been amplified successfully in a previous PCR, to the positive control sample. Vortex the tubes gently, and spin them quickly to collect the liquid on the bottom of the tubes.
5. Put all PCR tubes into the thermocycler and start the reaction with the following parameters: initial denaturation at 98 $^\circ\text{C}$ for 5 min, followed by 94 $^\circ\text{C}$ for 10 s, 32 cycles (denaturation at 94 $^\circ\text{C}$ for 30 s, annealing at 54 $^\circ\text{C}$ for 30 s, extension at 72 $^\circ\text{C}$ for 45 s) and a final extension at 72 $^\circ\text{C}$ for 10 min. Stop reaction at the '94 $^\circ\text{C}$ for 10 s' step, and add 0.5 μL *Taq* polymerase enzyme to each tube. This is required, since the half-life of the enzyme at 98 $^\circ\text{C}$ is very short, and the addition of the enzyme directly to the master mix would result in the inactivation of a significant amount of the enzyme during the initial denaturation step.
6. Prepare 1 % agarose gel, and check the amount and quality of PCR products (EXERCISE 77, steps 9-12).
7. PCR products can be stored for a few days at 4 $^\circ\text{C}$. Long-term storage can be achieved at -20 $^\circ\text{C}$.

SUPPLEMENTARY EXERCISE S7: AMPLIFICATION OF dissimilatory sulphite reductase genes (*dsrAB*) WITH PCR FROM sulphate reducing bacteria

The detailed description of sulphate reducing bacteria is to be found in EXERCISE 95. Dissimilatory sulphite reductase genes (*dsrAB*) are phylogenetic markers, which are present in this functional group of anaerobic bacteria.

Object of study, test organisms:

genomic DNA extracted from an environmental sample

Materials and equipment:

micropipettes, sterile pipette tips
 microcentrifuge and PCR tubes
 microcentrifuge
 microcentrifuge tube rack
 10 \times PCR buffer
 25 mM MgCl_2 solution
 1 mM dNTP mix
 forward and reverse primers:
 DSR1f primer: 5' ACS CAC TGG AAG CAC G 3'
 DSR4r primer: 5' GTG TAG CAG TTA CCG CA 3'
 1 U/ μL *Taq* polymerase enzyme
 dH_2O [DEPC(diethyl pyrocarbonate)-treated distilled water]
 vortex mixer
 thermocycler
 laboratory scales
 250 mL flask
 electrophoresis system
 agarose
 10 \times TBE solution (see Appendix)
 measuring cylinder
 DNA stain
 loading buffer (see Appendix)
 DNA ladder (e.g. pUC Mix, Marker 8, Fig. 39)

Practise:

1. Let frozen DNA samples and PCR reagents thaw at room temperature.
2. Label a 1.5 mL microcentrifuge tube (this will be used for preliminary mixing of the master mix) and some PCR tubes (the amount is determined by the number of DNA samples plus two additional tubes for the positive and negative controls).
3. Make a preliminary mix using: 2.5 μL 10 \times PCR buffer, 2.0 μL MgCl_2 , 5.0 μL dNTP mix, 0.25 μL forward primer, 0.25 μL reverse primer, 1.0 μL DNA sample, 0.5 μL *Taq* polymerase enzyme filled up to a final volume of 25 μL with dH_2O per reaction in a 1.5 mL microcentrifuge tube by multiplying the above amounts with the number of DNA samples plus three (for controls and pipetting errors; see Appendix). Do not add DNA samples and enzyme to the master mix!
4. Pipette 23.5 μL master mix into each labelled PCR tube, and add 1.0 μL DNA sample to the appropriate tubes. Do not add DNA to the negative control sample, but add DNA, which had been amplified successfully in a previous PCR, to the positive control sample. Vortex the tubes gently, and spin them quickly to collect the liquid on the bottom of the tubes.
5. Put all PCR tubes into the thermocycler and start the reaction with the following parameters: initial denaturation at 98 $^\circ\text{C}$ for 5 min, followed by 94 $^\circ\text{C}$ for 10 s, 35 cycles (denaturation at 94 $^\circ\text{C}$ for 45 s, annealing at 54 $^\circ\text{C}$ for 45 s, extension at 72 $^\circ\text{C}$ for 90 s) and a final extension at 72 $^\circ\text{C}$ for 10 min. Stop reaction at the '94 $^\circ\text{C}$ for 10 s' step, and add 0.5 μL *Taq* polymerase enzyme to each tube. This is required, since the half-life of the enzyme at 98 $^\circ\text{C}$ is very short, and the addition of the enzyme directly to the master mix would result in the inactivation of a significant amount of the enzyme during the initial denaturation step.
6. Prepare 1 % agarose gel, and check the amount and quality of PCR products (EXERCISE 77, steps 9-12).
7. PCR products can be stored for a few days at 4 $^\circ\text{C}$. Long-term storage can be achieved at -20 $^\circ\text{C}$.

12.2. Taxon information sheets with supplementary figures

Wohlfahrtiimonas chitiniclastica

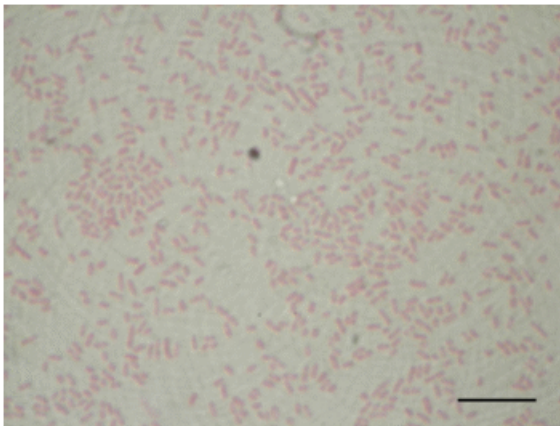

Supplementary Figure S1. Gram-stained light microscopic image of *Wohlfahrtiimonas chitiniclastica*

S5^T cells grown on KingB agar medium. Scale bar: 10 μm .

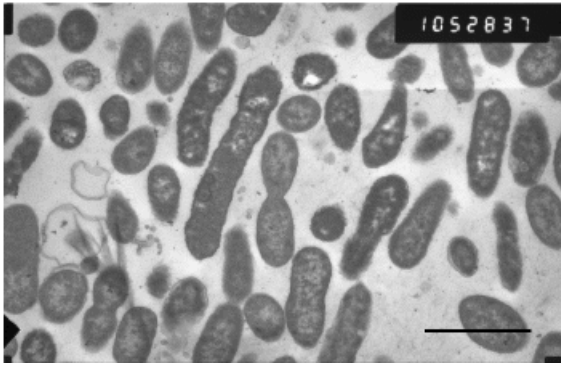

Supplementary Figure S2. Transmission electron microscopic image of *Wohlfahrtiimonas chitiniclastica* S5^T cells grown on KingB agar medium. Scale bar: 2µm. (Photo: Attila L. Kovács, 2007)

Taxonomic assignment:

Domain: Bacteria
 Phylum: Proteobacteria
 Class: Gammaproteobacteria
 Order: Xanthomonadales
 Family: Xanthomonadaceae
 Genus: Wohlfahrtiimonas

Type strain: S5^T = DSM 18708^T = CCM 7401^T.

Isolation source: 3rd stage larvae of *Wohlfahrtia magnifica* (Diptera: Sarcophagidae).

GenBank accession number for the 16S rRNA gene of the type strain: AM397063

Short description:

Cells are Gram-negative, short, rod-shaped (0.5-1 µm x 1.5-2.0 µm) and non-motile. Colonies on King B agar medium are non-pigmented, small, convex, entire, smooth and glistening with an entire margin.

Have chemoheterotrophic metabolism. Strictly aerobic, mesophilic (optimum growth occurs at 28-37°C), neutrophiles (optimum growth is between pH 5.0 and 10.5). Catalase and oxidase positive bacteria.

Negative in Voges-Proskauer, aesculin, urease, indole, casease, gelatinase, amylase, H₂S production and TWEEN 80 utilisation. They have strong chitinase activity.

The predominant fatty acids are C_{18:1} and C_{14:0} and the major respiratory quinone is Q8. Predominant polar lipids are phosphatidylglycerol, phosphatidyletanolamine and phosphatidylserine. G+C content of DNA is 44.3 mol%.

Reference:

M. Tóth, E., Schumann, P., Borsodi, A. K., Kéki, Zs., Kovács, A. L., Márialigeti, K. 2008. *Wohlfahrtiimonas chitiniclastica* gen. nov., sp. nov., a new gammaproteobacterium isolated from *Wohlfahrtia magnifica* (Diptera: Sarcophagidae). International Journal of Systematic and Evolutionary Microbiology 58: 976–981.

Ottowia pentelensis

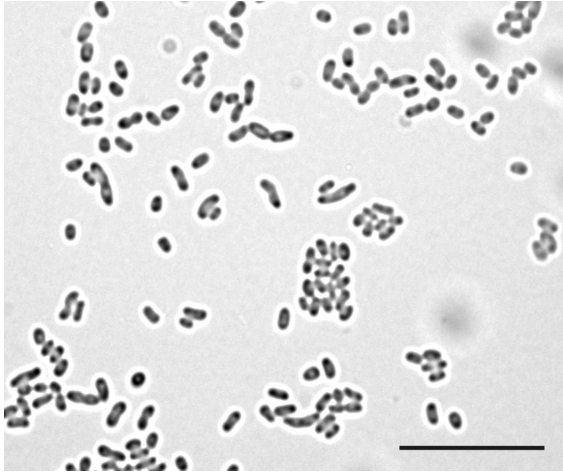

Supplementary Figure S3. Phase-contrast light microscopic image of *Ottowia pentelensis* RB3-7^T cells grown on R2A. Clear parts within the cells are with metachromatic granules. Scale bar: 10 μ m.

Taxonomic assignment:

Domain: Bacteria
 Phylum: Proteobacteria
 Class: Betaproteobacteria
 Order: Burkholderiales
 Family: Comamonadaceae

Type strain: RB3-7^T = DSM 21699^T = NCAIM B 02336^T

Isolation source: activated sludge of a laboratory-scale system treating coke plant effluent

GenBank accession number for the 16S rRNA gene of the type strain: EU518930

Short description:

Cells are Gram-negative, short-rod-shaped (0.5-0.7 μ m x 1.0-1.7 μ m) and non-motile. Colonies on TSA medium are beige, circular, smooth and slightly raised with an entire margin (0.2–1.0 mm in diameter).

Cells are aerobic and mesophilic with a chemoheterotrophic respiratory metabolism. Growth occurs at 4–37 °C (optimum, 20–28°C) and at pH 5–12 (optimum, pH 6–8). Flocs are formed in liquid culture (R2A medium). Poly- β -hydroxybutyrate granules are present inside the cells (TS medium). (See Suppl Fig. S3.).

Catalase- and oxidase-positive. Negative for reduction of nitrate to nitrite and for denitrification. Aesculin is not hydrolysed. Negative for indole production, gelatine hydrolysis and D-glucose fermentation.

The predominant fatty acids are C_{16:0}, cycloC_{17:0}, C_{18:1} ω 7c and C_{16:1} ω 7c, and the major respiratory quinone is Q-8. Predominant polar lipids are phosphatidylglycerol, phosphatidyletanolamine, phosphatidyl-methyl-ethanolamine and diphosphatidylglycerol. The G+C content of the genomic DNA is 68.5 mol%.

Reference:

Felföldi, T., Kéki, Zs., Sipos, R., Márialigeti, K., Tindall, B.J., Schumann, P., Tóth, E.M. 2011. *Ottowia pentelensis* sp. nov., a floc-forming betaproteobacterium isolated from an activated sludge system treating coke plant effluent. International Journal of Systematic and Evolutionary Microbiology 61: 2146-2150.

Tahibacter aquaticus

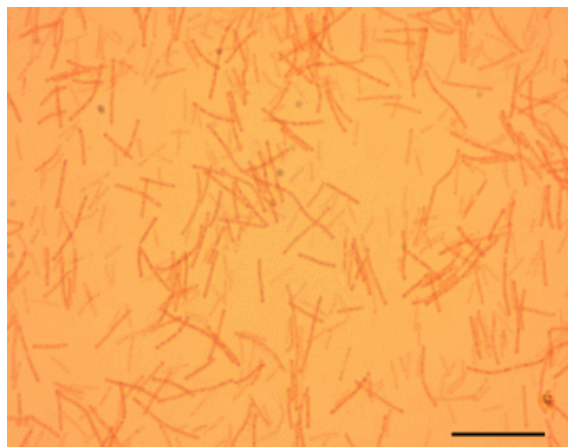

Supplementary Figure S4. Gram-stained light microscopic image of *Tahibacter aquaticus* strain PYM5-11^T grown on R2A agar medium. Scale bar: 10 μ m.

Taxonomic assignment:

Domain: Bacteria
Phylum: Proteobacteria
Class: Gammaproteobacteria
Genus: Tahibacter

Type strain: PYM5-11^T = DSM 21667^T = NCAIM B 02337^T.

Isolation source: drinking water supply system of Budapest, Hungary

GenBank accession number for the 16S rRNA gene of the type strain: AM981201

Short description:

Cells are straight or slightly curved rods (3.2-7.2 μ m x 0.32-0.34 μ m), occurring alone or in short filaments. Colonies are bright yellow, translucent and convex with entire edges after 3 days of growth on R2A agar medium. pH optimum of growth is between pH 5.0 and 7.0, optimum temperature is at 20-28°C. Cannot grow with 2.5-10% (w/v) NaCl. Catalase and oxidase positive. Negative for Voges-Proskauer test, glucose fermentation, indole production from tryptophan and nitrite reduction. Does not hydrolyse urea, aesculin, casein, starch and does not produce H₂S from peptone. Positive for TWEEN 80 utilisation, phosphatase activity and variable for hydrolysis of gelatine and nitrate reduction to nitrite.

Major fatty acids are iso-C_{15:0}, iso-C_{17:1 ω 9c}, summed feature 3 (comprising C_{16:1w ω 7c} and/or iso-C_{15:0}2-OH), and C_{16:0}. The DNA G+C content is 65.4 mol%. The predominant polar lipids are diphosphatidylglycerol, phatidylglycerol and phosphatidyletanolamine.

Reference:

Makk, J., Homonnay, Z. G., Kéki, Zs., Lejtovicz, Zs., Márialigeti, K., Spröer, C., Schumann, P., Tóth, E. M. 2011. *Tahibacter aquaticus* gen. nov., sp. nov. a new gammaproteobacterium isolated from the drinking water network of Budapest (Hungary). *Systematic and Applied Microbiology*, 34: 110-115.

Siphonobacter aquaeclarae

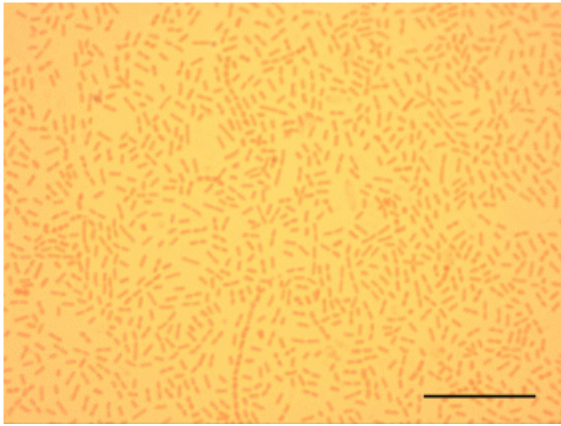

Supplementary Figure S5. Gram-stained light microscopy image of *Siphonobacter aquaeclarae* strain P2^T grown on R2A agar medium. Scale bar: 20 µm.

Taxonomic assignment:

Domain: Bacteria
 Phylum: Bacteroidetes
 Class: Cytophaga
 Order: Cytophagales
 Family: Cytophagaceae
 Genus: Siphonobacter

Type strain: P2^T = DSM 21668^T = NCAIM B 02328^T

Isolation source: biofilm of the inner surface of an ultrapure water pipeline system in a Hungarian power plant.

GenBank accession number for the 16S rRNA gene of the type strain: FJ177421

Short description:

Cells are Gram-negative, facultative anaerobic, non-motile rods (1.3–2.7 µm x 0.3–0.4 µm) occurring singly or in pairs. Positive for catalase and negative for oxidase reaction as well as nitrate reduction. Growth occurs at 4–37°C and with pH 5–9. Methyl red test is positive, but Voges-Proskauer reaction is negative. Positive for hydrolyses of gelatine, starch and Tween 80. No casease and urease activity can be observed.

Predominant fatty acids are C₁₆:1w5c, summed feature 3 (iso-C₁₅:0 2-OH and/or C₁₆:1w7c; 17.2%), iso-C₁₇:0 3-OH and iso-C₁₅:0. The major respiratory quinone is MK-7. *Predominant polar lipid is* phosphatidyletanolamine. The genomic DNA G+C content of the type strain is 54.5 mol%.

Reference:

Táncsics, A., Kéki, Zs., Márialigeti, K., Schumann, P., Tóth, E. M. 2010. *Syphobacteraquaclarae* gen.nov., sp. nov., a new member of the family “*Flexibacteraceae*”, phylum *Bacteroidetes*. *International Journal of Systematic and Evolutionary Microbiology*. 60: 2567-2571.

Nocardioides hungaricus

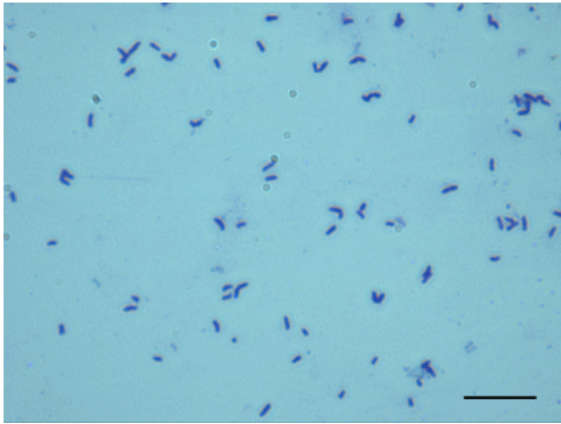

Supplementary Figure S6. Gram-stained light microscopy image of *Nocardioides hungaricus* cells grown on R2A medium for 24 hrs. Scale bar: 10 μ m.

Taxonomic assignment:

Domain: Bacteria
Phylum: Actinobacteria
Class: Actinobacteria
Subclass: Actinobacteridae
Order: Actinomycetales
Suborder: Propionibacterinae
Family: Nocardioideaceae
Genus: Nocardioides

Type strain: 1RaM5-12^T (=DSM 21673^T =NCAIM 02330^T)

Isolation source: drinking water network of Budapest, Hungary.

GenBank accession number for the 16S rRNA gene of the type strain: AM981198

Short description:

Cells are Gram-positive (Gram-variable in old cultures), 0.4-0.66 μ m x 0.9-1.7 μ m in size after 1 day of incubation on R2A agar medium. Non-motile, and their metabolism is of aerobic respiratory type. Catalase-positive and oxidase-negative. Colonies on R2A medium after 7 days of incubation are white, smooth, circular and convex. Growth occurs at 20–37°C (optimum 20–28°C), at pH 5–9 (optimum pH 6–7) and with 0.0–2.5% NaCl. Urease and phosphatase activity, Voges-Proskauer and methyl-red reactions are negative and do not produce indole from tryptophan or H₂S from peptone. Aesculin is hydrolysed. Nitrate is reduced to nitrite.

The major fatty acids are iso-C₁₆:₀ and anteiso-C₁₇:₀. The predominant menaquinone is MK-8(H4). The only polar lipid is diphosphatidylglycerol. The DNA G+C content of the type strain is 71.4 mol%.

Reference:

Tóth, E. M., Kéki, Zs., Makk, J., Homonnay, ZG., Márialigeti, K., Schumann, P. 2011. *Nocardioides hungaricus* sp. nov., isolated from the drinking water supply system of Budapest (Hungary) International Journal of Systematic and Evolutionary Microbiology 61: 549-553.

Nocardioides daphniae

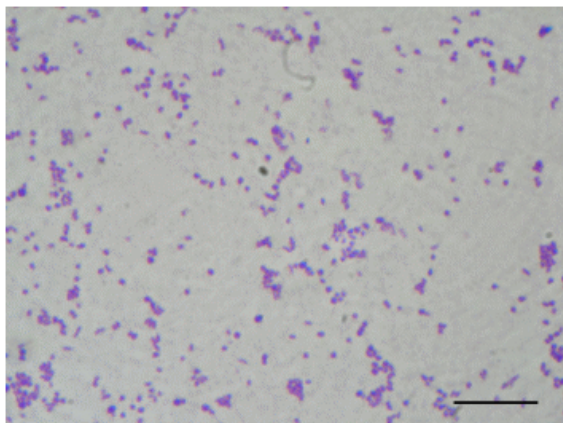

Supplementary Figure S7. Gram-stained light microscopy image of *Nocardiooides daphniae* cells grown on R2A agar medium. Scale bar: 20 μm .

Taxonomic assignment:

Domain: Bacteria
 Phylum: Actinobacteria
 Class: Actinobacteria
 Subclass: Actinobacteridae
 Order: Actinomycetales
 Suborder: Propionibacterinae
 Family: Nocardiooidaceae

Genus: *Nocardiooides*

Type strain: D287^T = DSM 18664^T = CCM 7403^T

Isolation source: intestine of *Daphnia cucullata* (water flea) originating from Lake Balaton, Hungary.

GenBank accession number for the 16S rRNA gene of the type strain: AM398438.

Short description:

Cells are *Gram-positive*, *non-motile*, *short rods or coccoid* (0.8-1.0 μm x 1.2-2.2 μm), *aerobic*, *oxidase-negative* and *catalase-positive*. Colonies on King B agar medium are *yellowish*, *circular*, *convex*, *smooth* and *shiny*. The temperature range for growth is 4-38°C, optimum growth occurs at 28°C. The pH range for growth is pH 5.5-10.5, the optimal range is between pH 7 and 9. Growth occurs in the presence of 0-5 % NaCl. *H₂S*, *indole* production from tryptophan, *Voges-Proskauer*, *haemolysis* and *α -glucosidase* reactions are *negative*. *Acid from glucose* is not produced. *Chitinase* enzyme is produced. *Caseinase* reaction is *weak*.

The diagnostic diamino acid of the peptidoglycan is LL-2,6 diaminopimelic acid. The predominant cellular fatty acid is iso-C_{16:0} the major menaquinone is MK-8(H₄). Its polar lipids are phosphatidylglycerol and diphosphatidylglycerol. The DNA G+C content is 69.9 mol%.

Reference:

Tóth, E. M., Kéki, Zs., Homonnay Z.G., Borsodi, A. K., Márialigeti, K., Schumann, P. 2008. *Nocardiooides daphniae* sp. nov., isolated from *Daphnia cucullata* (Crustacea: Cladocera). International Journal of Systematic and Evolutionary Microbiology 58: 78-83.

Aquipuribacter hungaricus

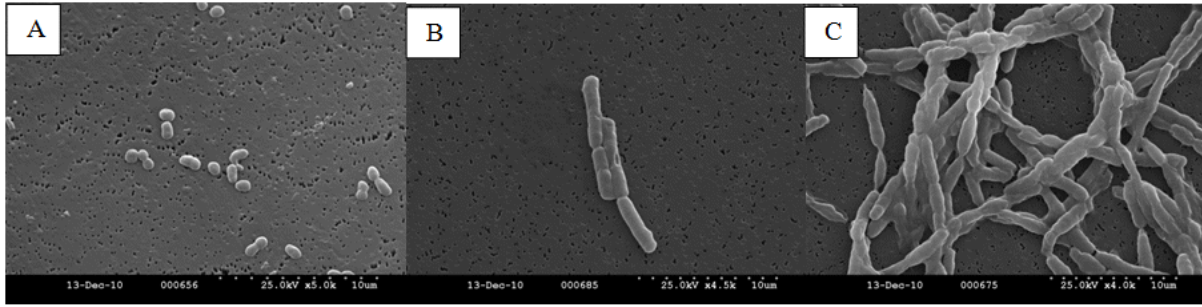

Supplementary Figure S8. Transmission electron microscopic image of *Aquipuribacter hungaricus* grown on R2A medium. The morphological cell cycle is visible: A: 8-18hrs; B: 24-36 hrs; C: older than 72 hrs.

Taxonomic assignment:

Domain: Bacteria
 Phylum: Actinobacteria
 Class: Actinobacteria
 Subclass: Actinobacteridae
 Order: Actinomycetales
 Suborder: Micrococquinae
 Family: Intrasporangiaceae
 Genus: *Aquipuribacter*

Type strain: IV-75^T=DSM 21674^T=NCAIM B 02333^T

Isolation source: ultra-pure water of the water purification system of a Hungarian power plant

GenBank accession number for the 16S rRNA gene of the type strain: FM179321

Short description:

Cells are Gram-staining positive. A morphological cell cycle can be observed: rods are 0.9–1.1 μm x 3.8–6.2 μm; cocci are 0.9–1.4 μm in diameter. Cells are non-motile.

Colonies on R2A agar medium after 7 days of incubation are pale orange, smooth, convex and circular. Catalase positive and oxidase-negative. Growth occurs at 20–37°C, with optimal temperature between 20-28 °C.

pH optimum is 7-8. Does not reduce nitrate to nitrite. Aesculin is hydrolysed. H₂S from peptone and indole from tryptophan are not produced. Aesculin is hydrolysed but negative for urease, casease, gelatinase, phosphatase activity.

The predominant fatty acids are anteiso-C_{15:0}, C_{18:1ω9c} and C_{16:0}. The major menaquinone is MK-10(H₄).

Predominant polar lipids are phosphatidylglycerol, two unidentified phospholipids and one glycolipid. The DNA G+C content of the type strain is 75.0 mol%.

Reference:

Tóth, E. M., Kéki, Zs., Bohus, V., Borsodi, A. K., Márialigeti, K., Schumann, P. 2012. *Aquipuribacter hungaricus* gen. nov., sp. nov., a novel actinobacterium isolated from the ultra-pure water system of a Hungarian power plant. International Journal of Systematic and Evolutionary Microbiology 62: 556-562.

Bacillus aurantiacus

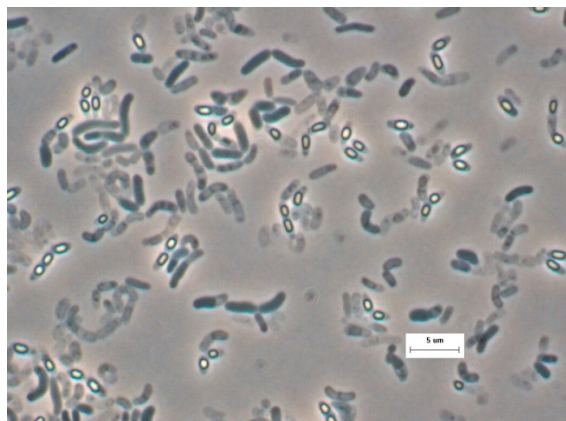

Supplementary Figure S9. Gram-stained light microscopic photo of *Bacillus aurantiacus*. Refractile oval bodies are ripened endospores. Scale bar: 5 μm .

Taxonomic assignment:

Domain: Bacteria
 Phylum: Firmicutes
 Class: Bacilli
 Order: Bacillales
 Family: Bacillaceae
 Genus: Bacillus

Type strain: *K1-5^T* = *DSM 18675^T* = *CCM 7447^T* = *NCAIM B002265^T*.

Isolation source: *sediment of Kelemen-szék, an extremely shallow soda lake situated in Kiskunság National Park (Hungary).*

GenBank accession number for the 16S rRNA gene of the type strain: AJ605773

Short description:

Cells are Gram-positive, straight rods (0.8–1.0 μm x 3.2–4.5 μm). Central to subterminal, ellipsoidal endospores (0.5–0.8 x 1.0–1.2 μm) are formed in unswollen sporangia. Cells are non-motile. Colonies are goldish-orange, circular, entire, smooth and convex on modified seawater medium DSM 246 (<http://www.dsmz.de/catalogues/catalogue-microorganisms/culture-technology/list-of-media-for-microorganisms.html>).

Obligate aerobic. Catalase positive, oxidase-negative. Acid is not produced from D-glucose and nitrate is not reduced to nitrite. Voges–Proskauer and methyl-red reactions are negative. Urea, aesculin, casein and starch are not hydrolysed. Tyrosine decomposition and phenylalanine deamination are negative. Simmons' citrate is not used. Production of H_2S and indole is negative. Phosphatase is not produced. Tween 80 is hydrolysed.

No growth is detected at pH 7.0–7.5. Growth occurs between pH 8.0 and 12.0. Growth occurs optimally at pH 9.5–10.0 and with 3–7% (w/v) NaCl. Temperature range for growth is between 10 and 45°C, with optimum growth at 28°C.

Major fatty acids are anteiso- $\text{C}_{15:0}$, iso- $\text{C}_{15:0}$ and anteiso- $\text{C}_{17:0}$. The cell-wall peptidoglycan contains meso-diaminopimelic acid. The DNA G+C content of the type strain is 42.9 mol%.

Reference:

Borsodi, A. K., Márialigeti, K., Szabó, G., Palatinszky, M., Pollák, B., Kéki, Zs., Kovács, A.L., Schumann, P., Tóth, E. M. 2008. *Bacillus aurantiacus* sp. nov., a novel alkaliphilic and moderately halophilic bacterium isolated from Hungarian soda lakes. *International Journal of Systematic and Evolutionary Microbiology* 58: 845-851.

Bacillus alkalisediminis

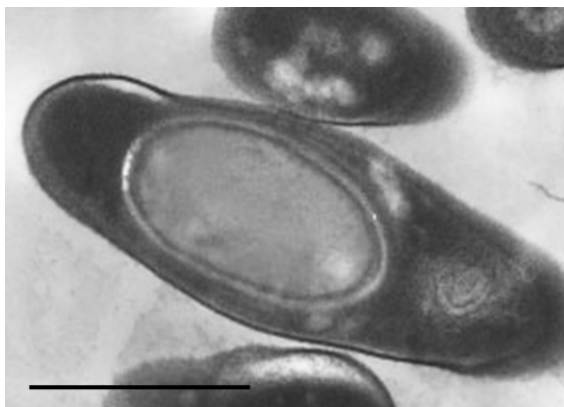

Supplementary Figure S10. Electron microscopic photo of a *Bacillus alkalisediminis* cell containing a central ellipsoidal endospore. Scale bar: 1 μm .

Taxonomic assignment:

Domain: Bacteria
 Phylum: Firmicutes
 Class: Bacilli
 Order: Bacillales
 Family: Bacillaceae
 Genus: Bacillus

Type strain: *K1-25^T* = DSM 21670^T = NCAIM B02301^T.

Isolation source: *sediment of Kelemen-szék, an extremely shallow soda pond situated in Kiskunság National Park (Hungary).*

GenBank accession number for the 16S rRNA gene of the type strain: AJ606037

Short description:

Cells are Gram-positive, non-motile, straight rods (0.8–0.9 μm x 2.0–3.0 μm). Central, ellipsoidal *endospores* (0.5–0.8 x 1.0–1.2 μm) are formed in swollen sporangia. Colonies are creamy brown, circular, entire, smooth and convex on modified seawater medium DSM 246 (<http://www.dsmz.de/catalogues/catalogue-microorganisms/culture-technology/list-of-media-for-microorganisms.html>).

No acid and gas are produced from D-glucose, L-arabinose, D-mannitol and D-xylose. Voges–Proskauer and methyl-red reactions are negative. Nitrate is reduced to nitrite but not to nitrogen under aerobic conditions; no nitrate reduction occurs under anaerobic conditions. Hydrolysis of gelatine and aesculin is positive. Casein, starch, urea and arginine are not hydrolysed. Simmons' citrate is not used. Production of H₂S, indole and phosphatase is negative.

Growth occurs at pH 7.0–12.0, optimally at pH 9.0. The range of NaCl concentration for growth is 2–10% (w/v), optimally with 5% (w/v) NaCl. Temperature range for growth is 15–37°C, with optimum growth at 25–28°C. Aerobic, catalase-positive, oxidase-negative.

The major fatty acids are anteiso-C15:0, and iso-C15:0. The cell-wall peptidoglycan contains meso-diaminopimelic acid. The DNA G+C content is 36.3–39.0 mol%.

Reference:

Borsodi, A. K., Pollák, B., Kéki, Zs., Rusznyák, A., Kovács, A. L., Spröer, C., Schumann, P., Márialigeti, K., Tóth, E. M. 2011. *Bacillus alkalisediminis* sp. nov., a novel alkaliphilic bacterium isolated from the sediment of extremely shallow Hungarian soda ponds. *International Journal of Systematic and Evolutionary Microbiology* 61: 1880–1886.

Cellulomonas phragmiteti

Taxonomic assignment:

Domain: Bacteria
 Phylum: Actinobacteria
 Class: Actinobacteria
 Order: Actinomycetales
 Family: Cellulomonadaceae
 Genus: Cellulomonas

Type strain: *KB23^T* = *DSM 22512^T* = *NCAIM B002303^T*.

Isolation source: *Phragmites australis*-associated biofilm originating from a soda pond located in Kiskunság National Park (Hungary).

GenBank accession number for the 16S rRNA gene of the type strain: AM902253

Short description:

Cells are Gram-positive, facultative anaerobic, motile rods. Colonies on King's B agar plates are smooth, yellow to pale orange and circular within 3 days at 25°C.

Catalase-positive and oxidase-negative. Growth occurs under anaerobic conditions on King's B agar. Hydrolyses casein, gelatine, aesculin and Tween 80. Cellulase is produced. Does not produce indole from tryptophan or hydrogen sulphide from cysteine. Positive methyl-red test but negative for Voges-Proskauer reaction. Negative for nitrate reduction. Positive for urease but negative for phosphatase.

Growth occurs at 15–37°C, at pH 7.0–9.0 and in the presence of 2.0–7.0% (w/v) NaCl. Optimum growth occurs at 25°C, at pH 8.0 and with 5.0% (w/v) NaCl.

The peptidoglycan is of type A4β (L-Orn-D-Asp). The predominant menaquinone is MK-9(H₄). The major cellular fatty acids are anteiso-C_{15:0}, C_{16:0} and anteiso-C_{15:1}. The G+C content of the genomic DNA of the type strain is 74.8 mol%.

Reference:

Rusznayk, A., Tóth, E.M., Schumann, P., Makk, J., Szabó, G., Vladár, P., Márialigeti, K., Borsodi, A.K. 2011. *Cellulomonas phragmiteti* sp. nov., a cellulolytic bacterium isolated from reed (*Phragmites australis*) periphyton in a Hungarian shallow soda pond. *International Journal of Systematic and Evolutionary Microbiology* 61: 1662-1666.

Pannonibacter phragmitetus

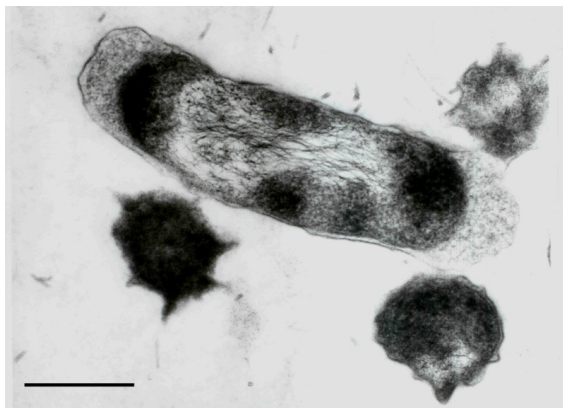

Supplementary Figure S11. Longitudinal section electron micrograph showing a rod-shaped cell of *Pannonibacter phragmitetus* C6/19^T. Gram-negative cell wall structure and cap-like structures on both poles can be observed. Scale bar: 0.5 μm.

Taxonomic assignment:

Domain: Bacteria
 Phylum: Proteobacteria
 Class: Alphaproteobacteria
 Order: Rhodobacterales
 Family: Rhodobacteraceae
 Genus: Pannonibacter

Type strain: *C6/19^T* = *DSM 14782^T* = *NCAIM B02025^T*.

Isolation source: *surface of decomposing reed (Phragmites australis) rhizomes from Lake Fertő (Hungary).*

GenBank accession number for the 16S rRNA gene of the type strain: AJ400704

Short description:

Cells are motile with polar flagella, contain PHA, Gram-negative, straight to slightly curved rods (2.0–4.0 µm x 0.3–0.6 µm). On Horikoshi alkaline agar medium, colonies are small (2–4 mm in diameter), whitish beige coloured, circular, entire, smooth and convex.

Facultative anaerobic, chemo-organotrophic. Oxidase and catalase are positive. Nitrate is reduced to nitrogen. No methyl-red or Voges–Proskauer reactions occur. Aesculin, casein, cellulose, gelatine, hippurate, starch and Tween 80 hydrolysis, phenylalanine deamination and production of H₂S and indole are negative. Arginine is hydrolysed and citrate is utilised. Urease and phosphatase activities are positive.

Major cellular fatty acid is C18:1ω7c and the main polar lipids are phosphatidyl glycerol, diphosphatidyl glycerol, phosphatidyl ethanolamine and phosphatidyl serine. The predominant respiratory quinone is Q-10. The G+C content is 64.6 mol%.

Reference:

Borsodi, A. K., Micsinai, A., Kovács G., Tóth, E. M., Schumann, P., Kovács, A. L., Böddi B., Márialigeti, K. 2003. *Pannonibacter phragmitetus* gen. nov., sp. nov., a novel alkalitolerant bacterium isolated from decomposing reed rhizomes in a Hungarian soda lake. *International Journal of Systematic and Evolutionary Microbiology* 53: 555-561.

Thermus composti

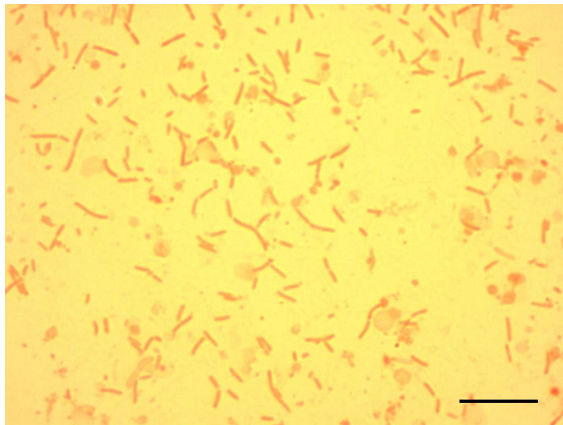

Supplementary Figure S12. Gram stained light microscopy image of *Thermus composti* strain K-39^T grown on R2A agar medium for 24 hrs. Scale bar: 10 µm.

Taxonomic assignment:

Domain: Bacteria
 Phylum: Deinococcus-Thermus
 Class: Deinococci
 Order: Thermales

Family: Thermaceae

Type strain: K-39^T = DSM 21686^T = NCAIM B 02340^T

Isolation source: thermophilic phase of the composting process for oyster mushroom substrate preparation.

GenBank accession number for the 16S rRNA gene of the type strain: EU701067

Short description:

Cells are Gram-negative, rod-shaped (0.4-0.8 µm x 2-8 µm) and non-motile. Colonies are small, white, bright and round on R2A medium after 2 days incubation (0.05–0.1 mm in diameter).

Aerobic and thermophilic. Growth occurs at 40–80°C (optimum, 65–75°C) and at pH 5–9 (optimum, pH 7).

Catalase- and oxidase-positive. Negative for reduction of nitrate to nitrite and for denitrification. Casein and starch are not hydrolysed. Negative for α- and β-galactosidase. Utilizes trehalose, Casamino acids, maltose, D-glucose, acetate, D-fructose and pyruvate. Weak growth is exhibited on melibiose, L-glutamate, L-glutamine, L-arginine, L-asparagine, cellobiose, malate and succinate. Does not utilize acetamide, citrate, D-galactose, D-sorbitol, D-xylose, erythritol, propionate, glycerol, lactose, L-arabinose, L-rhamnose, L-serine, raffinose, L-sorbose, myo-inositol or formate.

The predominant fatty acids are iso-C_{17:0}, anteiso-C_{17:0}, C_{16:0} and iso-C_{15:0}, and the major respiratory quinone is MK-8. Predominant polar lipids are one major phospholipid (PL1) and glycolipid (GL2). Peptidoglycan type is A3β L-Orn-Gly-Gly. The G+C content of the genomic DNA is 71.3 mol%.

Reference: Vajna, B., Kanizsai, Sz., Kéki, Zs., Márialigeti, K., Schumann, P., Tóth, E. M. 2012. *Thermus composti* sp. nov., isolated from oyster mushroom compost. International Journal of Systematic and Evolutionary Microbiology 62: 1486-1490.

12.3. Test results with supplementary figures

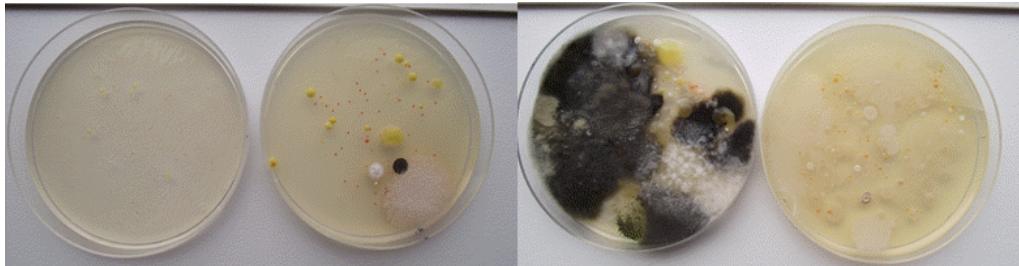

Supplementary Figure S13: Sampling surfaces for microbiological contamination (exercise 9) I.: culture made from swabbing the surface of the laboratory bench.

Supplementary Figure S14: Sampling surfaces for microbiological contamination (exercise 9) II.: culture made from swabbing the surface of a shoe tread.

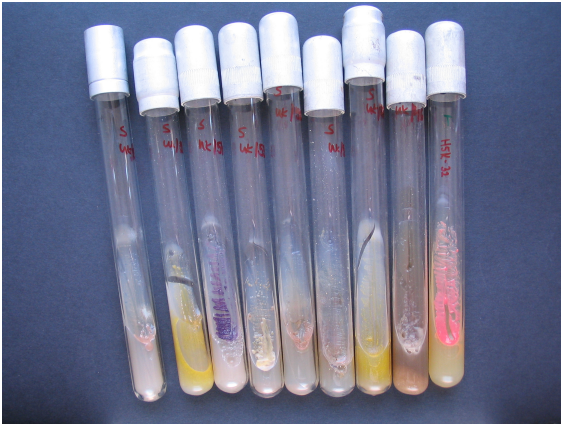

Supplementary Figure S15: Isolation of Petri dish plate cultures from the agar surface (exercise 27) I.: isolates from a water sample.

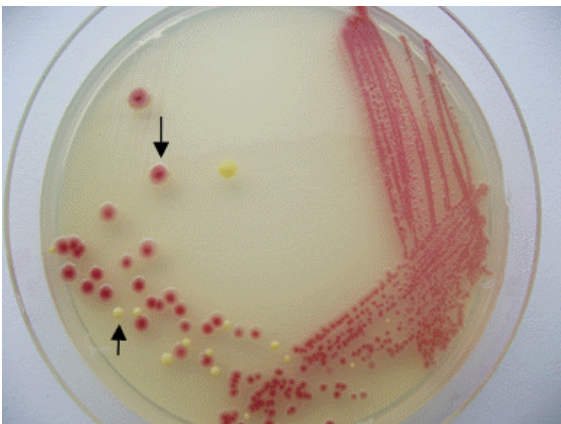

Supplementary Figure S16: Preparation of pure cultures by streak plate method (exercise 28). Isolate e.g. the colonies mashed with an arrow.

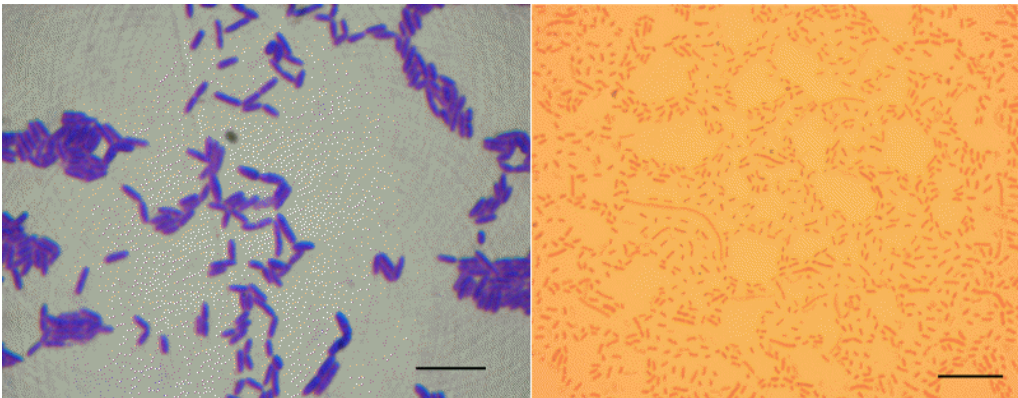

Supplementary Figure S17: Gram staining (exercise 37) I.: Gram positive cells of a *Bacillus* sp.

Supplementary Figure S18: Gram staining (exercise 37) II.: Gram negative cells of *Spingobacterium* sp. Scale bar: 10 μ m.

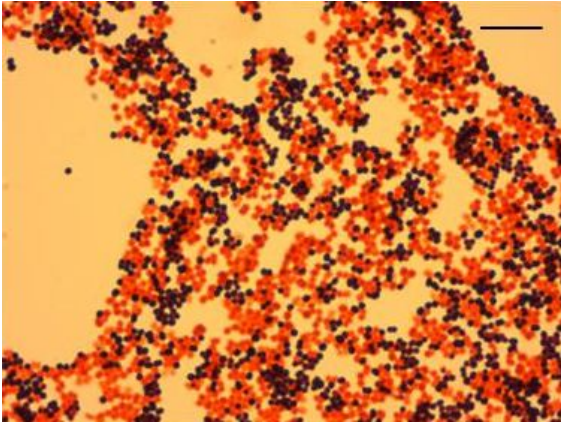

Supplementary Figure S19: Gram staining (exercise 37) III. Gram variable cells of *Salinococcus* sp. Scale bar: 10 μm .

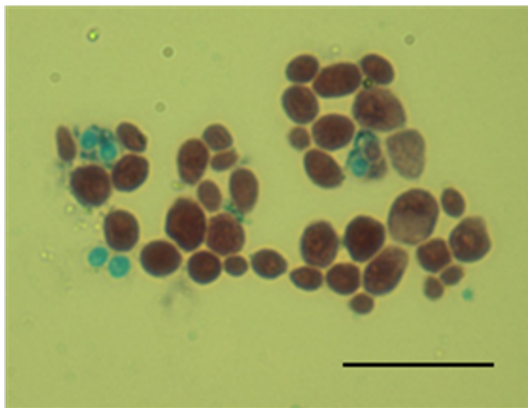

Supplementary Figure S20: Schaffer-Fulton spore staining (exercise 40): *Saccharomyces cerevisiae* spores are green oval bodies, while cells stain red. Scale bar: 10 μm .

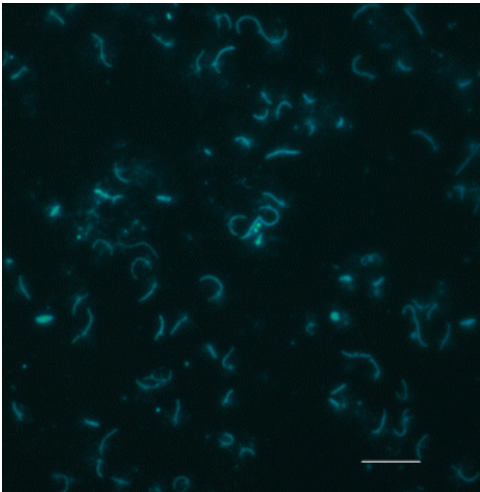

Supplementary Figure S21: DAPI stained image of a water sample originated from Lake Medve (Transilvania) (exercise 14). Scale bar: 10 μm .

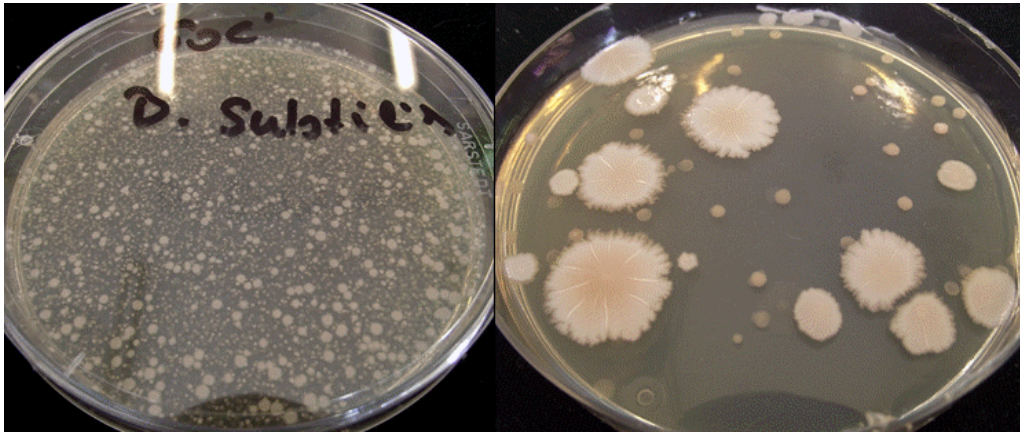

Supplementary Figure S22: Tolerance of bacteria to heat treatment (exercise 61) I.: Growth of *Bacillus subtilis* colonies following a 10 min 60°C heat treatment of their suspension made in agar medium.

Supplementary Figure S23: Tolerance of bacteria to heat treatment (exercise 61) II.: Growth of *Bacillus subtilis* colonies following a 10 min 90°C heat treatment. Observe the drastical change in the colony count, while inoculation was made with equal germ count.



Supplementary Figure S24: Effect of temperature on microbial growth (exercise 60): cultivation of *Micrococcus luteus* at 4, 28 and 37°C for one week on surface of nutrient slant. No growth occurred at 4°C.



Supplementary Figure S25: Membrane filter after cultivation (10 mL water was filtered) from a natural lake (exercise 17).

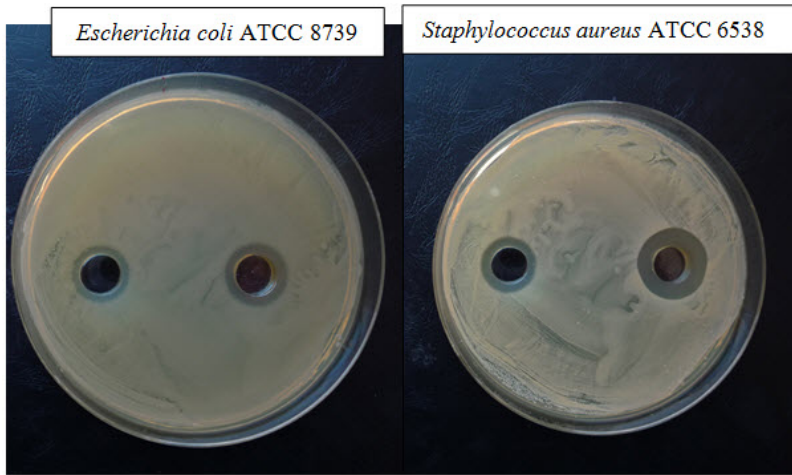

Suppl Figure S26: Antagonistic effect of nanosilver (different concentrations) on the multiplication of *Escherichia coli* strain ATCC 8739 (exercise 72).

Suppl Figure S27: Antagonistic effect of nanosilver (different concentrations) on the multiplication of *Staphylococcus aureus* strain ATCC 6538 (exercise 72).

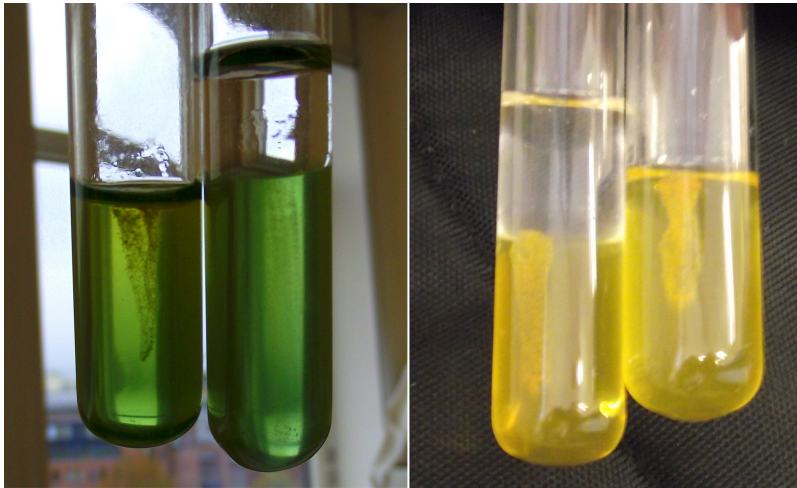

Supplementary Figure S28: Results of Hugh-Leifson test (exercise 52) I.: Negative reaction in both tubes reports on the lack of acid production from glucose.

Supplementary Figure S29: Results of Hugh-Leifson test (exercise 52) II.: Both anaerobic (fermentative) and aerobic degradation of glucose appeared (yellow color).

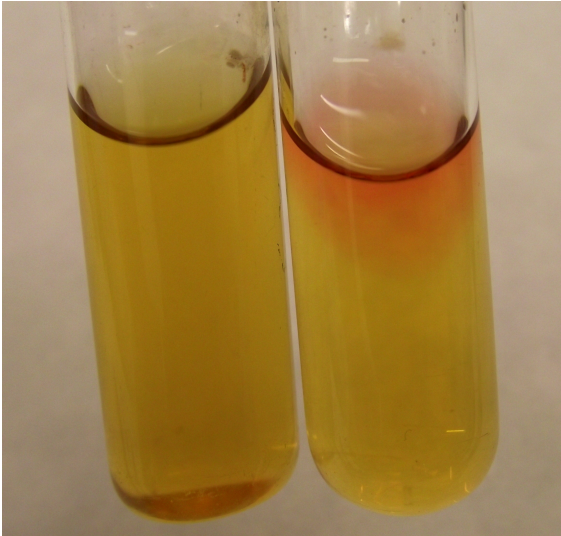

Supplementary Figure S30: Results of Voges-Proskauer reaction (exercise 53). Positive reaction is indicated by the red colonisation at the top of the medium.



Supplementary Figure S31: Presence of *Pseudomonas* colonies on Brolacin differential agar medium (exercise 87). Typical *Pseudomonas* colonies are large with brownish centre and the surrounding agar is blue.

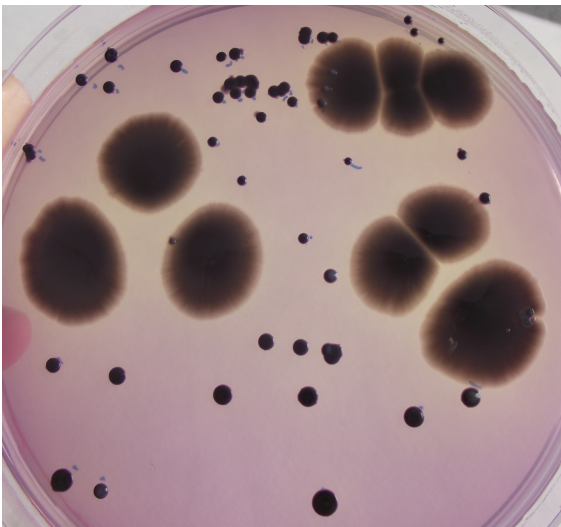

Supplementary Figure S32: Demonstration of *Streptococcus* spp. of faecal origin using the differential medium Szita E-67 (exercise 86). Typical colonies are relatively small, round and black.

Chapter 13. LIST OF EXERCISES

- 1: OPERATION OF THE AUTOCLAVE
- 2: MICROBIOLOGICAL CONTROL OF AN AUTOCLAVE BY USING THE SPORE PREPARATION OF *GEOBACILLUS STEAROTHERMOPHILUS* ATCC 7953
- 3: DETERMINATION OF THE MICROBIOLOGICAL EFFICACY OF DISINFECTANTS
- 4: ASSESSMENT OF THE MICROBIOLOGICAL AIR QUALITY OF THE LABORATORY WITH SEDIMENTATION
- 5: ASSESSMENT OF THE MICROBIOLOGICAL AIR QUALITY OF THE LABORATORY WITH A MAS-100 OR WITH AN AES SAMPLE AIR-MK2 EQUIPMENT
- 6: ASSESSMENT OF THE MICROBIOLOGICAL AIR QUALITY OF THE LABORATORY WITH RCS Plus EQUIPMENT
- 7: SOIL SAMPLING FOR MICROBIOLOGICAL STUDIES
- 8: WATER SAMPLING FROM A RIVER OR LAKE
- 9: SAMPLING SURFACES FOR MICROBIOLOGICAL CONTAMINATION
- 10: SAMPLING FOR MICROBES INHABITING SKIN SURFACES I.
- 11: SAMPLING FOR MICROBES INHABITING SKIN SURFACES II.
- 12: EXAMINATION OF MICROORGANISMS INHABITING NATURAL WATERS BY BRIGHT-FIELD LIGHT MICROSCOPY (WET MOUNT PREPARATION)
- 13: DETERMINATION OF *ASPERGILLUS NIGER* SPORE CONCENTRATION WITH BÜRKER-CHAMBER
- 14: ENUMERATION OF MICROBES WITH DAPI STAINING
- 15: QUANTIFYING HETEROTROPHIC MICROBES USING THE SPREAD-PLATE TECHNIQUE
- 16: *QUANTIFYING HETEROTROPHIC BACTERIA USING THE POUR-PLATE TECHNIQUE*
- 17: *QUANTIFYING HETEROTROPHIC BACTERIA USING THE MEMBRANE FILTER TECHNIQUE*
- 18: *DETERMINATION OF THE NUMBER OF MESOPHILIC ANAEROBIC SPORE-FORMING (SULPHITE REDUCING) BACTERIA WITH MPN METHOD*
- 19: PREPARING SAUERKRAUT IN THE LABORATORY
- 20: DEMONSTRATION OF MICROBES DIGESTING PECTIN - ACTION OF PECTINASES DURING ANAEROBIC DIGESTION - “HEMP-RETTING”
- 21: DEMONSTRATION OF MICROBES DIGESTING PECTIN – SOFT-ROT TEST
- 22: PREPARATION OF AGAR SLANTS
- 23: PREPARATION OF AGAR PLATES
- 24: PREPARATION OF AGAR PLATES WITH AUTOMATIC EQUIPMENT
- 25: PREPARATION OF ENRICHMENT CULTURES
- 26: PREPARATION OF WINOGRADSKY COLUMN FOR THE ENRICHMENT OF PHOTOTROPHIC BACTERIA

- 27: ISOLATION OF CULTURES FROM THE AGAR SURFACE
- 28: PREPARATION OF PURE CULTURES BY THE STREAK PLATE METHOD
- 29: CULTIVATION OF ANAEROBIC BACTERIA IN SODIUM THIOGLYCOLATE MEDIUM
- 30: CULTIVATION OF ANAEROBIC BACTERIA USING MARINO PLATES
- 31: CULTIVATION OF ANAEROBIC BACTERIA IN AN ANAEROBIC JAR
- 32: DEMONSTRATION OF THE ANAEROBIC CHAMBER (GLOVE-BOX)
- 33: PROCEDURE OF CULTURE TRANSFER (SUBCULTURING)
- 34: MAINTENANCE OF BACTERIAL CULTURES WITH FREEZE-DRYING
- 35: OBSERVING COLONY MORPHOLOGY ON INOCULATED PLATES
- 36: SIMPLE STAINING
- 37: GRAM STAINING
- 38: JAPANESE GRAM TEST
- 39: ZIEHL-NEELSEN ACID-FAST STAINING
- 40: SCHAEFFER-FULTON SPORE STAINING
- 41: CAPSULE STAINING BY LEIFSON
- 42: HANGING DROP PREPARATION
- 43: PREPARING SLIDE-CULTURES WITH HUMIDITY CHAMBERS
- 44: CATALASE ACTIVITY
- 45: OXIDASE ACTIVITY
- 46: METHYLENE BLUE REDUCTION
- 47: CASEINASE ACTIVITY
- 48: GELATINASE ACTIVITY
- 49: α -AMYLASE ACTIVITY
- 50: LYPOLYTIC ACTIVITY (TWEEN 80 HYDROLYSIS)
- 51: NUCLEASE (DN-ASE) ACTIVITY
- 52: HUGH-LEIFSON TEST
- 53: METHYL RED-VOGES-PROSKAUER REACTION
- 54: AESCULIN HYDROLYSIS
- 55: H₂S PRODUCTION
- 56: INDOLE TEST
- 57: PHOSPHATASE ACTIVITY
- 58: HAEMOLYSINE PRODUCTION

- 59: USE OF TSI MULTITEST MEDIUM FOR THE DIFFERENTIATION OF GRAM-NEGATIVE BACTERIA
- 60: EFFECT OF TEMPERATURE ON MICROBIAL GROWTH
- 61: TEMPERATURE TOLERANCE OF BACTERIA
- 62: EFFECT OF pH ON MICROBIAL GROWTH
- 63: EFFECT OF WATER ACTIVITY (A_w) ON MICROBIAL GROWTH
- 64: EFFECT OF UV RADIATION ON BACTERIAL GROWTH
- 65: DETERMINATION OF THE LYSOZYME CONTENT OF EGG WHITE
- 66: STUDING THE EFFECT OF ANTIBIOTICS USING THE KIRBY-BAUER METHOD 68: SCREENING THE ANTIMICROBIAL EFFECT OF THE CULTURE FILTRATE OF A *STREPTOMYCES* STRAIN
- 67: *IN VITRO* SYNERGISM OR ANTAGONISM OF DIFFERENT ANTIBIOTICS
- 68: SCREENING THE ANTIMICROBIAL EFFECT OF THE CULTURE FILTRATE OF A *STREPTOMYCES* STRAIN
- 69: DETECTION OF ANTAGONISM BETWEEN MICROBES USING CROSS-STREAK EXPERIMENTS
- 70: APPLICATION OF REPLICA-TECHNIQUE FOR THE ISOLATION OF ANTIBIOTIC-SENSITIVE OR -RESISTANT MICROBES
- 71: STUDYING THE ANTIMICROBIAL COMPOUNDS PRODUCED BY PLANTS
- 72: EFFECT OF HEAVY METAL IONS ON BACTERIA
- 73: DETERMINATION OF DAP CONTENT OF BACTERIAL CELLS
- 74: DETERMINATION OF ISOPRENOID QUINONE COMPOSITION OF BACTERIAL CELLS
- 75: DETERMINATION OF FATTY ACID PROFILE OF BACTERIA
- 76: DETERMINATION OF VOLATILE FERMENTATION END PRODUCTS OF BACTERIAL CULTURES AND FOOD SAMPLES
- 77: DNA EXTRACTION FROM BACTERIAL STRAINS
- 78: AMPLIFICATION OF THE 16S rDNA WITHPCR AND PURIFICATION OF THE PCR PRODUCT
- 79: RESTRICTION DIGESTION OF PCR PRODUCTS
- 80: DNA NUCLEOTIDE SEQUENCE ANALYSIS
- 81: DISTINGUISHING BACTERIAL STRAINS USING THE RAPD FINGERPRINTING TECHNIQUE
- 82: COLI-COUNT DETERMINATION BY MEMBRANE FILTER TECHNIQUE
- 83: COLI-COUNT DETERMINATION BY SPREAD PLATE TECHNIQUE
- 84: COLI-COUNT DETERMINATION BY MPN METHOD IN LMX BROTH
- 85: DETERMINATION OF COLIPHAGES FROM SURFACE WATERS BY THE POUR-PLATE TECHNIQUE
- 86: DEMONSTRATION OF *STREPTOCOCCUS* OF FAECAL ORIGIN USING THE MEDIUM SZITA E-67
- 87: CULTURING PSEUDOMONADS ON BROLACIN AGAR

- 88: RAPID TEST FOR THE DETECTION OF SOIL CATALASE ENZYME ACTIVITY
- 89: ESTIMATION OF SOIL MICROBIAL ACTIVITY BY MEASURING CO₂ PRODUCTION
- 90: EXAMINATION OF BACTEROID MORPHOLOGY
- 91: STUDY OF CYANOBACTERIA WITH HETEROCYSTS OCCURRING IN NATURAL WATER SAMPLES
- 92: DEMONSTRATION OF AMMONIFICATION
- 93: DEMONSTRATION OF NITRIFICATION AND INHIBITION OF NITRIFICATION
- 94: DEMONSTRATION OF DISSIMILATORY NITRATE REDUCTION
- 95: ESTIMATING THE NUMBER OF SULPHATE REDUCING BACTERIA (SRB) BY MPN METHOD
- 96: APPLYING IMMOBILISED CELL TECHNIQUE IN ETHANOL FERMENTATION
- 97: CITRIC ACID PRODUCTION IN SHAKEN CULTURE
- 98: CLUSTER ANALYSIS BASED ON THE PHENOTYPICAL CHARACTERS OF UNKNOWN BACTERIAL STRAINS
- 99: DETERMINATION OF CHLOROPHYLL-A CONTENT IN PHYTOPLANKTON SAMPLES BY METHANOL EXTRACTION
- 100: DIATOM PREPARATION FOR LIGHT MICROSCOPY

Chapter 14. APPENDIX

14.1. Using LABOVAL 4 type microscopes for bright-field light microscopic observations

1. Carefully take out the Laboval 4 type microscope (Fig. 10) from the cupboard by grasping the stand and set it on the laboratory table turning the stage towards you. Remove the polyethylene dust bag.. Connect to the power supply.
2. Turn on the lights by pressing the power switch (1). Place a specimen onto the stage, and select an adequate area of the specimen by moving the stage (2) in the correct direction. Rotate the 10x objective lens into the path of the light, and set the condenser system (3) to the upper collision.
3. Turn the field lens (4) into light path and swing the 10x objective lens into position; look into the microscope, find the object plane and bring the specimen image into focus using the coarse and fine focus knobs (5). Turn the field lens (4) away from the light path, and swing the 40x objective into position. Remove the right hand eyepiece (6) from the tube, and completely open the aperture diaphragm (7). Look into the tube from approximately 30 cm, and focus the diaphragm condenser using the condenser focus knob (3). Close the diaphragm to two thirds of the exit pupil of objective for optimum illumination. Place the eyepiece back into the tube.
4. Always set the aperture diaphragm (7) for each objective to achieve the right contrast and depth of focus. Adjust the binocular tube (8) by bending it to the appropriate value (to the interpupillary distance of your eyes, when the two view fields become one. Make a dioptre adjustment after focusing on a specimen with the coarse and fine focus knob. Look into thr right eyepiece with your right eye only and focus the specimen. Then focus the specimen with dioptre ring (9) while looking into the left eyepiece with your left eye only.
5. Light intensity can be modified by the brightness control dial (10) or by applying gray filters (11). The normal position of the brightness control dial is at value 6. When using low-magnification objectives (3.2x, 10x), turn the field lens into the light beam in order to illuminate the entire field.
6. Drop immersion oil onto the upper surface of the object when the 100x objective is used. Approach the specimen with the objective using the coarse focus knob (5), while observing the distance between the specimen and the objective front lens sideways. While looking into the microscope, focus the image of the specimen by raising the objective lens with the fine focus knob. Finishing the use of an oil immersion objective, clean it with a cloth moistened with benzine.
7. Microscope must always be covered with the dust bag and put back to its place at the end of practice.

14.2. Culture media used in the practical

Ammonia broth

$(\text{NH}_4)_2\text{SO}_4$	2.0	g
$\text{MgSO}_4 \times \text{H}_2\text{O}$	0.5	g
$\text{FeSO}_4 \times 7 \text{H}_2\text{O}$	0.03	g
NaCl	0.3	g
MgCO_3	10.0	g
K_2HPO_4	1.0	g
Distilled water	1000.0	mL

pH: 7.0

Ammonia broth

Sterilisation in autoclave: 121°C for 15 minutes

Wilson-Blair type agar

Peptone	8.0	g
Glucose	10.0	g
FeSO ₄	0.3	g
Brilliant green	0.016	g
Bismuth sulphite	26.0	g
Agar	18.0	g
Distilled water	1000.0	mL

pH: 7.4-7.8

Sterilisation by Tyndallisation

Blood agar

Nutrient agar	950.0	mL
Defibrinated sterile cattle or sheep blood	50.0	mL

Cool the sterile nutrient agar base to 50°C and add the blood aseptically. Stir rapidly, and pour plates.

Brolacin agar

Peptone	7.0	g
Yeast extract	2.0	g
Beef extract	2.0	g
Lactose	10.0	g
Cystine	0.128	g
Bromothymol blue	0.03	g
Agar	18.0	g
Distilled water	1000.0	mL

pH: 7.0-7.3

Sterilisation in autoclave: 121°C for 15 minutes

Casein agar – skim milk agar

Skim milk powder	28.0	g
Casein (dissolved in 10 mL 0.1 N NaOH)	5.0	g
Yeast extract	2.5	g
Glucose	1.0	g
Agar	18.0	g
Distilled water	1000.0	mL

pH: 6.8-7.2

Casein agar – skim milk agar

Sterilisation in autoclave: 121°C for 15 minutes

Cellulose-containing enrichment broth

Carboxymethyl cellulose	10.0	g
Yeast extract	0.1	g
NH ₄ Cl	0.5	g
NaH ₂ PO ₄ x H ₂ O	0.5	g
K ₂ HPO ₄	0.5	g
MgSO ₄ x 7 H ₂ O	0.5	g
NaCl	4.0	g
Trace element solution I.	1.0	mL
Distilled water	1000.0	mL

pH: 7.0

Sterilisation in autoclave: 121°C for 15 minutes

Trace element solution I.

CuSO ₄ x 5 H ₂ O	0.64	g
FeSO ₄ x 7 H ₂ O	0.11	g
MnCl ₂ x 4 H ₂ O	0.79	g
ZnSO ₄ x 7 H ₂ O	0.15	g
Distilled water	100.0	mL

Citric acid-producing broth

Glucose	140.0	g
NH ₄ NO ₃	2.5	g
KH ₂ PO ₄	2.5	g
MgSO ₄ x 7 H ₂ O	2.5	g
Trace element solution II.	1.0	mL
Distilled water	1000.0	mL

pH: 3.8

Sterilisation in autoclave: 121°C for 15 minutes

Trace element solution II.

CuSO ₄	0.006	g
ZnSO ₄	2.5	g
FeSO ₄	0.13	g
MnSO ₄	0.1	g
Distilled water	100.0	mL

Czapek agar

Saccharose	30.0	g
NaNO ₃	3.0	g
K ₂ HPO ₄	1.0	g
MgSO ₄ x 7 H ₂ O	0.5	g
KCl	0.5	g
FeSO ₄ x 7 H ₂ O	0.01	g
Yeast extract	2.0	g
Peptone	5.0	g
Agar	15.0	g
Distilled water	1000.0	mL

pH: 7.0

Sterilisation in autoclave: 121°C for 15 minutes

DNA-containing agar

DNA	2.0	g
Glucose	5.0	g
Casamino acids	5.0	g
K ₂ HPO ₄	5.0	g
NaCl	2.0	g
FeSO ₄	0.05	g
MgSO ₄	0.5	g
Agar	18.0	g
Distilled water	1000.0	mL

pH: 7.0-7.2

Sterilisation in autoclave: 121°C for 15 minutes

DRCM differential medium

Beef extract	8.0	g
Peptone	5.0	g
Casein	5.0	g
Yeast extract	1.0	g
Glucose	1.0	g
Starch	1.0	g
NaHSO ₃	0.5	g
Ammonium iron(III)citrate	0.5	g
Sodium acetate	5.0	g
Cysteine-HCl	0.5	g
Resazurin	2.0	mg
Distilled water	1000.0	mL

DRCM differential medium

pH: 6.9-7.3

Sterilisation in autoclave: 121°C for 15 minutes

Endo agar

Tryptose	10.0	g
Peptone from meat	5.0	g
Peptone from casein	5.0	g
Yeast extract	1.5	g
NaCl	5.0	g
K ₂ HPO ₄	4.375	g
KH ₂ PO ₄	1.375	g
Lactose	12.5	g
Na-desoxycholate	0.1	g
Na-lauryl sulphate	0.05	g
Basic fuchsin	1.05	g
Na ₂ SO ₃	2.1	g
Agar	18.0	g
Distilled water	1000.0	mL

pH: 7.0-7.2

Sterilisation in autoclave: 121°C for 15 minutes

Aesculin broth

Esculin	1.0	g
Fe(III)-citrate	0.5	g
Peptone broth	1000.0	mL

pH: 7.2-7.4

Sterilisation in autoclave: 121 °C for 15 minutes

Eosin-Methylene Blue (EMB) agar

Peptone	10.0	g
Lactose	10.0	g
K ₂ HPO ₄	2.0	g
Eosin	0.4	g
Methylene blue	0.065	g
Agar	18.0	g
Distilled water	1000.0	mL

Eosin-Methylene Blue (EMB) agar

pH: 7.0

Sterilisation in autoclave: 121°C for 15 minutes

Gasoline-containing enrichment broth

Gasoline	10.0	g
NH ₄ Cl	0.5	g
Na ₂ HPO ₄ x H ₂ O	0.5	g
KH ₂ PO ₄	0.5	g
MgSO ₄ x 7 H ₂ O	0.5	g
NaCl	4.0	g
Trace element solution III.	1.0	mL
Distilled water	1000.0	mL

pH: 7.0

Sterilisation in autoclave: 121°C for 15 minutes

Trace element solution III.

CuSO ₄ x 5 H ₂ O	0.64	g
FeSO ₄ x 7 H ₂ O	0.11	g
MnCl ₂ x 4 H ₂ O	0.79	g
ZnSO ₄ x 7 H ₂ O	0.15	g
Distilled water	100.0	mL

Gelatine agar

Gelatine	4.0	g
Distilled water	50.0	mL
Nutrient agar	950.0	mL

Soak gelatine in water. After it becomes completely soft, add it to the melted nutrient agar.

pH: 7.2-7.4

Sterilisation in autoclave: 121°C for 15 minutes

Glucose broth

Glucose	150.0	g
NH ₄ NO ₃	2.5	g
K ₂ HPO ₄	5.62	g
KH ₂ PO ₄	2.13	g
MgSO ₄ x 7 H ₂ O	2.5	g
Trace element solution IV.	1.0	mL

Glucose broth

Distilled water	1000.0	mL
-----------------	--------	----

pH: 3.8

Sterilisation in autoclave: 121°C for 15 minutes

Trace element solution IV.

CuSO ₄	0.006	g
ZnSO ₄	2.5	g
FeSO ₄	0.13	g
MnSO ₄	0.1	g
Distilled water	100.0	mL

HgCl₂-containing enrichment broth

Peptone	5.0	g
Glucose	0.5	g
(NH ₄) ₂ SO ₄	0.1	g
FeSO ₄ x 7 H ₂ O	0.1	g
HgCl ₂	2.0	mg
Distilled water	1000.0	mL

pH: 7.0

Sterilisation in autoclave: 121°C for 15 minutes

Hugh-Leifson semisolid agar deep tubes

Peptone	2.0	g
NaCl	5.0	g
K ₂ HPO ₄	0.3	g
Agar	3.0	g
Distilled water	1000.0	mL

pH: 7.1

Aqueous solution of bromothymol blue (0.2%)	15.0	mL
---	------	----

Sterilisation in autoclave: 121°C for 15 minutes

Cool the agar base to 50°C, and add aseptically the filter-sterilised glucose solution in 1% final concentration. Distribute the medium aseptically into test tubes (5 mL / 16x160 mm test tube) and let it solidify as deep medium. Half of the prepared medium should be aseptically covered by paraffin oil (petrolatum, minimum 10 mm depth).

LMX broth

Tryptose	5.0	g
----------	-----	---

LMX broth

NaCl	5.0	g
Sorbitol	1.0	g
Tryptophan	1.0	g
K ₂ HPO ₄	2.7	g
KH ₂ PO ₄	2.0	g
Lauryl sulphate sodium salt	0.1	g
1-Isopropyl-β-D-1-thio-galactopyranoside (IPTG)	0.1	g
5-Bromo-4-chloro-3-indolyl-β-D-galactopyranoside (X-GAL)	0.08	g
4-Methylumbelliferyl-β-D-glucuronide	0.05	g
Distilled water	1000.0	mL

pH: 6.8

Sterilisation in autoclave: 121°C for 15 minutes

Malt extract agar

Malt extract	50.0	g
Agar	18.0	g
Distilled water	1000.0	mL

pH: 5.6

Sterilisation in autoclave: 121°C for 15 minutes

Malt extract broth

Malt extract	50.0	g
Distilled water	1000.0	mL

pH: 5.6

Sterilisation in autoclave: 121°C for 15 minutes

Methylene blue broth

Tryptone	5.0	g
Beef extract	3.0	g
Aqueous solution of methylene blue (0.1%)	6.6	mL
Distilled water	1000.0	mL

pH: 7.0

Sterilisation in autoclave: 121°C for 15 minutes

MR-VP broth

Peptone	5.0	g
---------	-----	---

MR-VP broth

K ₂ HPO ₄	5.0	g
Glucose	5.0	g
Distilled water	1000.0	mL

pH: 7.5

Sterilisation in autoclave: 121°C for 15 minutes

Nitrate broth with Durham tubes

KNO ₃	1.0	g
Nutrient broth	1000.0	mL

pH: 7.2-7.4

Put Durham tubes inverted into the test tubes.

Sterilisation in autoclave: 121°C for 15 minutes

Nitrite broth

NaNO ₂	1.0	g
MgSO ₄ x 7 H ₂ O	0.5	g
FeSO ₄ x 7 H ₂ O	0.03	g
NaCl	0.3	g
Na ₂ CO ₃	1.0	g
K ₂ HPO ₄	1.0	g
Distilled water	1000.0	mL

pH: 7.2-7.4

Sterilisation in autoclave: 121°C for 15 minutes

Nutrient agar

Beef extract	3.0	g
Peptone	5.0	g
Agar	18.0	g
Distilled water	1000.0	mL

pH: 7.2-7.4

Sterilisation in autoclave: 121°C for 15 minutes

Nutrient broth

Beef extract	3.0	g
Peptone	5.0	g

Nutrient broth

Distilled water	1000.0	mL
-----------------	--------	----

pH: 7.2-7.4

Sterilisation in autoclave: 121°C for 15 minutes

Peptone broth

Peptone	10.0	g
NaCl	5.0	g
Distilled water	1000.0	mL

pH: 7.2-7.4

Sterilisation in autoclave: 121°C for 15 minutes

Na-phenolphthalein phosphate agar

Aqueous solution of Na-phenolphthalein-diphosphate (1%)	10.0	mL
Nutrient agar	1000.0	mL

Cool the agar base to 50°C and add aseptically freshly prepared, filter-sterilised solution of Na-phenolphthalein-diphosphate.

PMB (Postgate's Medium B) broth

Na-lactate	3.5	g
MgSO ₄ x 7 H ₂ O	2.0	g
NH ₄ Cl	1.0	g
CaSO ₄	1.0	g
Yeast extract	1.0	g
KH ₂ PO ₄	0.5	g
Distilled water	1000.0	mL

pH: 7.0-7.5

Sterilisation in autoclave: 121°C for 15 minutes

Iron-sulphate solution

FeSO ₄ x 7 H ₂ O	0.5	g
Distilled water	10.0	mL

Reductant solution

Na-thioglycollate	0.1	g
Ascorbic acid	0.1	g
Distilled water	10.0	mL

PMB (Postgate's Medium B) broth

Iron-sulphate and the reductant solution are heat and oxidation sensitive, hence prepare it in an anaerobic glove box, and filter-sterilise it with a 0.45 µm pore size membrane filter. Cool the sterile base to 50°C and add the solutions in the anaerobic system.

RMAC semisolid anaerobic agar

Peptone	10.0	g
Casein	10.0	g
NaCl	5.0	g
Meat extract	3.0	g
Yeast extract	1.5	g
Starch	1.0	g
Cysteine	1.0	g
Trizma base (Tris base)	1.0	g
Na ₂ SO ₃	0.4	g
Fe(III)-citrate	0.7	g
Agar	5.0	g
Distilled water	1000.0	mL

pH: 7.3-7.7

Sterilisation in autoclave: 121°C for 15 minutes

Starch agar

Water soluble starch	10.0	g
Distilled water	50.0	mL
Nutrient agar	950.0	mL

Dissolve the starch in distilled water, and add it to nutrient agar.

pH: 7.2-7.4

Sterilisation in autoclave: 121°C for 15 minutes

Starch casein agar

Soluble starch	10.0	g
Casein (dissolved in 10 mL 0.1 N NaOH)	1.0	g
K ₂ HPO ₄	0.5	g
Agar	18.0	g
Distilled water	1000.0	mL

pH: 7.2-7.4

Sterilisation in autoclave: 121°C for 15 minutes

Szita E67-agar

Nutrient agar	1000.0	mL
Glucose	10.0	g
Na-taurocholate	0.5	g
Aqueous solution of crystal violet (1%)	0.4	mL

pH: 7.0

The agar base is sterilised by free steaming for 30 minutes.

Aqueous solution of K-tellurite (1%)	5.0	mL
--------------------------------------	-----	----

Cool the steamed agar base to 50°C and add the K-tellurite solution aseptically.

Sodium thioglycollate broth

Peptone	15.0	g
Yeast extract	5.0	g
NaCl	5.0	g
Thioglycollic acid	1.0	g
Glucose	5.0	g
Agar	1.0	g
Aqueous solution of methylene blue (1%)	0.2	mL
Distilled water	1000.0	mL

pH: 7.2

Sterilisation in autoclave: 121°C for 15 minutes

TS (tryptone soya) agar

Tryptone	14.5	g
Soytone	5.0	g
NaCl	5.0	g
Agar	18.0	g
Distilled water	1000.0	mL

pH: 7.0-7.2

Sterilisation in autoclave: 121°C for 15 minutes

TSB (tryptone soya broth)

Tryptone	17.0	g
Soytone	3.0	g
Glucose	2.5	g
NaCl	5.0	g

TSB (tryptone soya broth)

K ₂ HPO ₄	2.5	g
Distilled water	1000.0	mL

pH: 7.0-7.3

Sterilisation in autoclave: 121°C for 15 minutes

TSI (Triple Sugar Iron) agar

Beef extract	3.0	g
Yeast extract	3.0	g
Peptone	20.0	g
Glucose	1.0	g
Lactose	10.0	g
Saccharose	10.0	g
FeSO ₄ x 7 H ₂ O	0.2	g
NaCl	5.0	g
Na ₂ S ₂ O ₃ x 5 H ₂ O	0.3	g
Agar	20.0	g
Distilled water	1000.0	mL
Aqueous solution of phenol red (0.2%)	12.0	mL

pH: 7.0

Sterilisation in autoclave: 121°C for 15 minutes

Pour 9 mL medium into 16x160 mm test tubes. Slant in a position to obtain also a deep butt.

Tween 80 agar

Peptone	10.0	g
CaCl ₂	0.1	g
NaCl	5.0	g
Tween 80	10.0	mL
Agar	18.0	g
Distilled water	1000.0	mL

pH: 7.0-7.4

Sterilisation in autoclave: 121°C for 15 minutes

Urea broth

Peptone	1.0	g
Glucose	1.0	g
NaCl	5.0	g

Urea broth

KH ₂ PO ₄	2.0	g
Phenol red	0.12	g
Distilled water	900.0	mL

pH: 6.8

Sterilisation in autoclave: 121°C for 15 minutes

Aqueous solution of urea (40%)	100.0	mL
--------------------------------	-------	----

Cool the sterile base medium to 50°C and add the filter-sterilised urea solution aseptically.

14.3. Dyes, reagents and solutions used in the practical

Acidic ethanol

HCl (cc.)	3.0	mL
Ethanol (95%)	97.0	mL

Acidic HgCl₂

HCl (cc.)	20.0	mL
HgCl ₂	15.0	g
Distilled water	100	mL

Dissolve HgCl₂ in water, then slowly add HCl.**Barritt's Reagent (for Voges-Proskauer test)***α-naphthol solution (Barritt's Reagent A)*

α-naphthol	6.0	g
Ethanol (95%)	100.0	mL

40% KOH solution (Barritt's Reagent B)

Potassium hydroxide	40.0	g
Distilled water	100.0	mL

Carbolfuchsin dye solution

Basic fuchsin	1.0	g
Ethanol (95%)	10.0	mL
Aqueous solution of phenol (5%)	100.0	mL

Crystal violet dye solution

Crystal violet (85% dye content)	1.0	g
Distilled water	100.0	mL

Crystal violet dye solution**DAP standard solution**

DAP	10	mg
Distilled water	10.0	mL

Griess-Ilosvay reagent*Reagent 1*

Sulphanilic acid	8.0	g
Acetic acid solution (5N)	1000.0	mL

Reagent 2

α -naphthylamine	5.0	g
Acetic acid solution (5N)	1000.0	mL

Iodine solution (Lugol's)

Iodine crystals	1.0	g
KI	2.0	g
Distilled water	300.0	mL

Kovács' reagent

N-amyl or isoamyl alcohol	150.0	mL
HCl (cc.)	50.0	mL
p-dimethylaminobenzaldehyde	10	g

Dissolve the aldehyde in alcohol, then slowly add HCl.

Loading buffer for agarose gel electrophoresis

Glycerol (87%)	57.5	mL
Bromophenol blue solution (1 M)	25.0	μ L
Xylene cyanol solution (1 M)	25.0	μ L
Distilled water	32.5	mL

Malachite green dye solution

Malachite green	5.0	g
Distilled water	100.0	mL

Methylene blue dye solution

Methylene blue	0.3	g
Ethanol (96%)	30.0	mL
Distilled water	1000.0	mL

Methyl-red indicator solution

Methyl-red	0.1	g
------------	-----	---

Methyl-red indicator solution

Ethanol (95%)	300.0	mL
Distilled water	200.0	mL

Nessler's reagent

KI	8.0	g
HgCl ₂	11.5	g
Distilled water	50.0	mL
NaOH solution (6 N)	50.0	mL

Dissolve reagents in 20 mL distilled water then add remaining water. Add NaOH solution and incubate for 24 hours. Transfer the supernatant into a clean bottle.

Ninhydrin reagent

Ninhydrin	0.2	mg
Ethanol (95%)	100.0	mL

Phosphate buffered saline (PBS) for DAPI

PBS stock solution	50.0	mL
NaCl	7.6	g
Distilled water	950.0	mL

PBS stock solution

Na ₂ HPO ₄ solution (0.2 M)	800.0	mL
NaH ₂ PO ₄ solution (0.2 M)	200.0	mL

pH: 7.2-7.4

Phosphate buffer for Exercise 65.

NaCl	8.0	g
KCl	0.2	g
Na ₂ HPO ₄	1.15	g
KH ₂ PO ₄	0.2	g
Distilled water	960.0	mL
Gelatine solution (1%)	40.0	mL

Dissolve the reagents in distilled water and then add the gelatine solution.

Sterilisation in autoclave: 121°C for 15 minutes

Reagents 1, 2, 3 and 4 in Exercise 75.*Reagent 1*

Sodium hydroxide (certified)	45.0	g
Methanol (reagent grade)	150.0	mL

Deionized distilled water	150.0	mL
<i>Reagent 2</i>		
6N HCl	325.0	mL
Methanol (reagent grade)	275.0	mL
<i>Reagent 3</i>		
Hexane (HPLC grade)	200.0	mL
Methyl-tert butyl ether (HPLC grade)	10.8	g
<i>Reagent 4</i>		
Sodium hydroxide (certified)		
Deionized distilled water		
Safranin dye solution		
Safranin	1.0	g
Distilled water	100.0	mL
Schweppe's reagent		
<i>Solution 1</i>		
Glucose	2.0	g
Distilled water	20.0	mL
<i>Solution 2</i>		
Aniline	2.0	g
Ethanol (95%)	20.0	mL

Mix solutions 1 and 2 and dilute to 60 mL with butyl alcohol. Always use freshly prepared reagent (can be stored for max. 24 hours at 4-8°C).

TRIS [tris(hydroxymethyl)aminomethane] buffer (1M, pH 8.0)

Trizma base (Tris base)	121.1	g
Double distilled water (fill up to)	1000.0	mL
HCl (cc.)	42.2	mL

pH: 8.0

Sterilisation in autoclave: 121°C for 15 minutes

10×TBE solution

Trizma base (Tris base)	107.8	g
Boric acid	55.0	g
EDTA	7.4	g
Double distilled water	1000.0	mL

10×TBE solution

pH: 8.3

Sterilisation in autoclave: 121°C for 15 minutes

14.4. Tables

Evaluation Table for Exercise 3.

Inspected materials	Inoculated microbe	1'	5'	15'	30'	45'	60'
1% Na-hypochlorite	<i>Staphylococcus aureus</i>						
1% Na-hypochlorite	<i>Pseudomonas aeruginosa</i>						
1% Na-hypochlorite	<i>Bacillus subtilis</i>						
2% Na-hypochlorite	<i>Staphylococcus aureus</i>						
2% Na-hypochlorite	<i>Pseudomonas aeruginosa</i>						
2% Na-hypochlorite	<i>Bacillus subtilis</i>						
0.9% NaCl	<i>Staphylococcus aureus</i>						
0.9% NaCl	<i>Pseudomonas aeruginosa</i>						
0.9% NaCl	<i>Bacillus subtilis</i>						
0.9% NaCl	_____						

McCardy statistical table (Exercise 18, 84, 95) for determining the most probable number of bacteria from the number of positive test tubes/wells using the MPN method.

Number of bacteria is given in MPN/mL (or MPN/g) in the lowest dilution of the positive tubes, if 0.1 mL (or g) sample is inoculated into each tube/well (in the case of 5 parallels and decimal series).

Positive Tubes			MPN/mL	Positive tubes			MPN/mL	Positive tubes			MPN/mL
0.1	0.01	0.001		0.1	0.01	0.001		0.1	0.01	0.001	
0	0	0	<1.8	3	0	2	13	4	5	1	48
0	0	1	1.8	3	1	0	11	5	0	0	23
0	1	0	1.8	3	1	1	14	5	0	1	31
0	1	1	3.6	3	1	2	17	5	0	2	43
0	2	0	3.7	3	2	0	14	5	0	3	58
0	2	1	5.5	3	2	1	17	5	1	0	33
0	3	0	5.6	3	2	2	20	5	1	1	46
1	0	0	2.0	3	3	0	17	5	1	2	63
1	0	1	4.0	3	3	1	21	5	1	3	84
1	0	2	6.0	3	3	2	24	5	2	0	49
1	1	0	4.0	3	4	0	21	5	2	1	70
1	1	1	6.1	3	4	1	24	5	2	2	94
1	1	2	8.1	3	5	0	25	5	2	3	120
1	2	0	6.1	4	0	0	13	5	2	4	150
1	2	1	8.2	4	0	1	17	5	3	0	79
1	3	0	8.3	4	0	2	21	5	3	1	110
1	3	1	10	4	0	3	25	5	3	2	140

APPENDIX

Positive Tubes			MPN/mL	Positive tubes			MPN/mL	Positive tubes			MPN/mL
0.1	0.01	0.001		0.1	0.01	0.001		0.1	0.01	0.001	
1	4	0	11	4	1	0	17	5	3	3	180
2	0	0	4.5	4	1	1	21	5	3	4	210
2	0	1	6.8	4	1	2	26	5	4	0	130
2	0	2	9.1	4	1	3	31	5	4	1	170
2	1	0	6.8	4	2	0	22	5	4	2	220
2	1	1	9.2	4	2	1	26	5	4	3	280
2	1	2	12	4	2	2	32	5	4	4	350
2	2	0	9.3	4	2	3	38	5	4	5	430
2	2	1	12	4	3	0	27	5	5	0	240
2	2	2	14	4	3	1	33	5	5	1	350
2	3	0	12	4	3	2	39	5	5	2	540
2	3	1	14	4	4	0	34	5	5	3	920
2	4	0	15	4	4	1	40	5	5	4	1600
3	0	0	7.8	4	4	2	47	5	5	5	>1600
3	0	1	11	4	5	0	41				

Based on Blodgett, R. J. 2005. Serial dilution with a confirmation step. *Food Microbiology* 22: 547-552.

Exercise 65

Small test tube (No.)	1	2	3	4	5	6	7
Buffer (mL)	0	2	3	3.5	3.75	3.88	3.94
Sample (mL) ^a	4	2	1	0.5	0.25	0.12	0.06
<i>M. luteus</i> suspension (mL)	0.3	0.3	0.3	0.3	0.3	0.3	0.3
Egg white OD (30 min.)							
Standard OD (30 min.)							

^a egg white or lysozyme solution

Exercise 78

Name and amount of reagents per reaction (µL)	Master mix of X samples
10× PCR buffer	2.5
MgCl ₂	2.0
dNTP mix	5.0
Forward primer	0.25
Reverse primer	0.25
DNA sample	1.0
<i>Taq</i> polymerase enzyme	0.5
dH ₂ O	13.5

Exercise 79

Name and amount of reagents per reaction (μL)		Master mix of X samples
Enzyme (10 U/ μL)	0.3	
10 \times enzyme buffer	2.0	
dH ₂ O	9.7	

Exercise 80

sequencing reaction

Name and amount of reagents per reaction (μL)		Master mix of X samples
5 \times sequencing buffer	1.5	
Ready Reaction Mix	1.0	
Primer	0.5	
dH ₂ O	4.0	

ethanol precipitation

Name and amount of reagents per reaction (μL)		Master mix of X samples
95% ethanol	62.5	
dH ₂ O	14.5	
3 M Na-acetate	3.0	

Exercise 81

Name and amount of reagents per reaction (μL)		Master mix of X samples
10 \times PCR buffer	2.5	
MgCl ₂	3.0	
dNTP mix	6.0	
M13 primer	2.0	
DNA sample	1.0	
<i>Taq</i> polymerase enzyme	1.0	
dH ₂ O	9.5	

Exercise 93

Evaluation of experiments used for the demonstration of nitrification

Nutrient media	The presence of which compound have you demonstrated?			What kind of oxidation has taken place?	
	NH ₄ ⁺	NO ₂ ⁻	NO ₃ ⁻	Ammonia	Nitrite
Ammonia					
Ammonia + ATU					
Nitrite					
Nitrite + ATU					

Chapter 15. WORKING DEFINITIONS

Acid-fast bacterium	A bacterium resistant to decolourisation with acidic-ethanol during Ziehl-Neelsen staining. The cell wall of the Gram-positive acid-fast bacteria contains mycolic acid.
Acidic dye	A dye that carries a negative charge on its chromophore group (e.g. eosine). Bacterial cells (as they are also negatively charged) reject it. They are used in special staining procedures.
Aerial mycelium	Web of hyphae mycelium that grows above the agar surface, may produce asexual reproductive spores (conidiospores) at bacteria.
Aerobic respiration	Requires oxygen as terminal electron acceptor in order to generate energy during cellular respiration.
Aerotolerant anaerobic bacterium	The energy driving metabolic processes of these types of bacteria are anaerobic (usually fermentative) but they produce enzymes (e.g. catalase, superoxide dismutase) that protect them from the toxic effects in the presence of oxygen.
Agar diffusion assay	In this assay utilisation, or inhibiting effect of different compounds is tested. The assayed molecules diffuse through the gelling agent, e.g. agar medium from a well (made in the agar by a cork borer or from a small disk vial). The concentration of the given substrate is proportional to the distance from the well disk. This technique is used to determine the sensitivity/resistance of a bacterial strain to an antimicrobial agent (e.g. antibiotic) (e.g. Kirby-Bauer procedure).
Agar plate	An agar solidified growth medium poured in a Petri dish (flat dish with a lid).
Agar slant	An agar medium solidified in a test tube in slanted position. The test tube is filled with melted agar medium and allowed to cool and harden at an angle position.
Agar-agar	Solidifying agent used to prepare solid media, prepared from marine red algae, a D-galactose based polysaccharide.
All-purpose medium	A microbial growth medium that allows the growth of many different types of bacteria.
Ammonification	The release of ammonia from N-containing molecules (e.g. amino acids, urea). Both pro- and eukaryotic cells produce enzymes participating in the process (e.g. urease, desaminase).
Amylase enzyme	An enzyme digesting starch into sugars.
Anaerobic jar	cultivation tightly closed container used to cultivate anaerobic bacteria. In the container the oxygen level is reduced and the carbon dioxide concentration usually increased using adequate chemicals.
Anaerobic respiration	A respiration which requires a substrate other than oxygen, e.g. nitrate, sulphate, elemental sulphur as terminal electron acceptor in order to generate energy during cellular respiration.
Antibiotic resistance	The ability of microorganisms to resist an antibiotic. Resistance can be ingenious or acquired.

WORKING DEFINITIONS

Antibiotic	A substance produced and released by microbes and active against other microbes (to kill or inhibit their growth). It is effective in small concentrations, exerts specific inhibitory effect on the metabolic processes of the target cells.
Antimicrobial agent	A general term circumscribing substances that kill or inhibit the growth of microbes (e.g. acetic acid, antibiotic).
ARDRA	Amplified Ribosomal DNA Restriction Analysis.
Autoclave	A pressure-bearing device to kill all known infectious agents (cells, spores, cysts, etc.) using pressurized saturated steam (e.g. at 121 °C for about 15–20 minutes).
Bacterial endospore	Endospores are strongly resistant structures with a thick wall formed by vegetative cells of genus <i>Bacillus</i> and closely related taxa during the process of sporulation. Bacteria with endospores can survive environmental stresses that would normally kill the bacterium.
Bacteriophage	Viruses of bacteria.
Bacteroid	Symbiotic form of certain bacteria (e.g. <i>Rhizobium</i> spp.) that are able to fix molecular nitrogen in the host cell symbiosom. Bacteroids are usually pleomorphic.
Basic dye	A dye that carries positive charge on its chromophore group. They are convenient to stain bacterial cells.
Biological nitrogen fixation	Only prokaryotic cells are able to fix molecular nitrogen into the form of ammonia using nitrogenase enzyme complex.
Capsule staining	The glycocalyx (capsule) of bacteria is not dense enough to be stained with simple staining methods. Usually negative staining procedure (background staining) is adequate for this purpose.
Casease enzyme	A proteolytic enzyme formed by certain bacteria that dissolves casein and albumin of the milk.
Catalase enzyme	An enzyme that breaks down hydrogen peroxide often produced under aerobic conditions to water and oxygen.
Cell count	The number of cells in a sample.
Colony forming unit (CFU)	The number of colonies that can be cultivated from a sample on a given medium.
Chemotaxonomy	science scientific field dealing with the chemical composition of microbial cells used for taxonomic purposes.
Chromatic aberration	An image defect in the optical system of a light microscope. It is caused by the use of white light dispersion, since the optical spectrum can not be focused at a single common point.
Coli-count	The number of coliform bacteria in 100 mL water sample, determined by cultivation based techniques.
Coliform bacterium	The common name of facultatively anaerobic, Gram negative faecal indicator organisms belonging to the family Enterobacteriaceae which ferment lactose within 24-48 hrs at 37°C, producing acid and gas in the process.
Coliphage	Viruses that infects <i>Escherichia coli</i> cells.

WORKING DEFINITIONS

Coli-titer	The smallest amount of water sample from which coliform bacteria can still be cultivated.
Colony morphology	The appearance of a microbial colony on the surface of an agar plate.
Colony	A visible mass of bacteria growing on agar surface or deep in the agar medium, presumably originating from a single mother cell.
Complex medium	A growth medium that is composed also of chemically undefined compounds, e.g. peptones, plant or meat extracts, etc.
Complex stain	A staining performed using more than one dye (e.g. differential staining).
DAP	Diaminopimelic acid, an usual amino acid characteristic in the murein of bacterial cells.
Denitrification	The release of volatile nitrogenous compounds e.g. molecular nitrogen, dinitrogen oxide, etc. as the product of nitrate respiration e.g. when nitrate serves as terminal electron acceptor.
Differential medium	A special medium that allows to distinguish between bacteria based on colony morphology evolved as a result of special biochemical reactions.
Differential stain	A staining technique that allows to categorize bacterial cells based on their staining properties e.g. Gram staining, acid-fast staining.
Disinfection	A technique to destroy pathogen microbes using chemical substrates on the surface of various objects.
Dry heat sterilisation	A process when sterilisation is carried out with dry heat, performed e.g. in a hot air steriliser.
Enrichment medium	A usually liquid growth medium that promotes the growth of a particular group of bacteria.
Facultative anaerobic bacterium	Bacteria capable of switching in their metabolic pathways. Under aerobic conditions, they use oxygen as terminal electron acceptor, but in lack of oxygen, they can use alternative electron acceptor(s), e.g. nitrate, sulphate; many of them are even able to ferment.
Fastidious bacterium	Bacteria having special nutritional requirements for growth.
Fermentation	a., A metabolic process where the biological energy (ATP) is produced on the substrate level. b., A biotechnological process to produce food (e.g. yoghurt), beverages, cells, drugs, enzymes, etc. or simply biomass is specially designed and operated vessels.
Gelatinase enzyme	An enzyme digesting gelatin.
Generation time	The time elapsing between two divisions in case of actively dividing cells.
Germ count	The number of microbial units in a sample that can be determined by cultivation from a given sample on a given medium (e.g. CFU=colony forming unit; MPN=Most probable number).
Germicidal effect	In general an agent or effect that kills “germs”, especially pathogens. E.g. the effect of UV radiation at wavelengths between 200-340 nm based on its DNA molecules damaging effect; chemical disinfectants; etc.

Glove-box	A closed chamber outfitted with a transparent screen, interchange and gloves to enable isolated manipulation with chemicals, microbes, etc. Glove boxes are suitable to cultivate strictly anaerobic microbes, or are used in the manipulation of pathogens.
Glycocalyx	In general terms synonym of capsule formed outside the cell wall of several microorganisms.
Gram-negative cell wall	Cell wall type of Bacteria. Consists of a thin layer of murein external to the periplasmic space over the cell membrane and a unique outer membrane carrying the lipopolysaccharide (LPS) layer. Lipoprotein bundles join the membranes and the murein. Gram-negative cells cannot retain the crystal violet dye during decolourisation, but take up the counterstain, therefore appear red or pinkish in Gram stained smears.
Gram-positive cell wall	Cell wall type of Bacteria. It consists of a thick layer of murein with teichoic acids fixing it to the cell membrane and spanning to the outer surface of the cells. Bacteria with this Gram-positive cell wall usually retain the crystal violet at decolourisation in Gram staining, therefore change colour to purple in Gram stained smears.
Gram-variable staining	Some bacteria yield a Gram-variable pattern in Gram stained smears, which is visible as a mixture of pink and purple cells with identical cell morphology in the microscopic field.
Hanging drop preparation	A technique in which a drop of bacterial suspension is hanging on a cover slide over a special depression slide (with a concave depression). The hanging drop method allows the possibility to check the motility of cells under a microscope.
Haemolysis	A rupture of red blood cells caused by microorganisms or by other conditions (e.g. toxic substances). In microbiology haemolysis is tested on blood agar plates. At α -haemolysis microbes cause a greenish discolouration around the bacterial colony. γ -haemolysis means a complete lysis and degradation of cells forming a clear zone around the colony.
Heterolactic fermentation	A type of fermentation when the end products of carbohydrate fermentation contain other acidic compounds in addition to the dominant lactic acid, e.g. acetic acid, ethanol, carbon dioxide.
Homolactic fermentation	A type of carbohydrate fermentation when the only end product is lactic acid.
Humidity chamber	A kind of moisture chamber to cultivate microorganisms in/on small volumes of media to check their cell morphology in vivo.
Hypha	A branching filamentous growth type of cells at bacteria and fungi.
Immobilised cell technique	A technique in which cells are bound, entrapped, localised to a suitable matrix to enhance the production of a compound by the repeated use of their catalytic activity.
Indicator bacteria	Special group(s) of bacteria used to detect and estimate the level of different environmental effects e.g. faecal indicator bacteria are used to detect the contamination of different waters.
Inoculation loop	A device used during the cultivation of microbes e.g. to transfer an amount of microbes aseptically between cultivation vessels.
Isolation	a., A procedure when a colony is picked up from an agar plate and transferred to a new sterile medium with an inoculation loop.

WORKING DEFINITIONS

	b., A containment technique to handle infectious agents.
Isoprenoid quinone	A group of molecule of the electron transport chains of organisms, which is able to transfer both protons and electrons.
Japanese Gram-test	A quick method to distinguish between bacteria with Gram-positive and Gram-negative cell walls, the Japanese Gram-test confirms the results of Gram staining. The principle of the technique is that, due to the effect of strong base (KOH), Gram-negative cells are opened and a thin filament can be pulled from their DNA.
Lipase enzyme	Esterase enzymes digesting lipids. E.g. triglyceride lipases are lipolytic enzymes that hydrolyse the ester linkages in triglycerides.
Liquid medium	A growth medium without gelling agent (broth).
Lyophilisation	Freeze drying, typically used to dehydrate / preserve susceptible materials. It is also a maintenance procedure of microorganisms when freeze-drying is applied.
Lysosyme enzyme	Muramidase, an enzyme that hydrolyses 1,4-beta-linkages between N-acetyl muramic acid and N-acetyl-D-glucosamine in the peptidoglycan of bacterial cell walls.
Magnification of a microscope	The degree of how an object is enlarged in a microscopic field. It is determined by the magnification of the objective and ocular lenses.
Membrane filter technique	A technique for the cultivation of microorganisms from liquid samples. The sample is filtered through a membrane, is then placed on a given medium and incubated.
Microaerophilic bacterium	Bacteria that require oxygen for growth, but optimum growth with most different substrates is achieved under reduced oxygen concentrations.
Mixed acid fermentation	The end products of fermentation of carbohydrates, proteins are various short chain organic acids.
MPN method	Most Probable Number method, in which the number of cultivable bacteria in a sample is estimated by serial dilution and inoculation into parallel liquid media and incubated.. Growth is evaluated and germ count is estimated using a statistical table.
Negative stain	Technique staining the background of the cell.
Neutral dye	A dye having no charge at the chromophore group, it is convenient to stain intracellular particles (e.g. lipid granules) of the cells.
Nitrification	The oxidation of ammonia to nitrite or nitrite to nitrate by different microorganisms.
Obligate aerobic bacterium	A bacterium that requires oxygen for growth; O ₂ is the terminal electron acceptor during respiration.
Obligate anaerobic bacterium	Bacteria sensitive for the presence of oxygen, they need an atmosphere without oxygen for growth.
Oxydase test	A test used in microbiology to detect certain cytochrome oxydase enzymes, one of the last members of the respiratory chain in microbes, transports the electron to the oxygen.

WORKING DEFINITIONS

Pasteurisation	A method of partial sterilisation with heat, reducing the germ count of microorganisms. At a given temperature, harmful microorganisms are destroyed without major changes in the chemistry of the substrate. E.g. milk is pasteurized by typically at 72°C for 15 seconds.
PCR	Polymerase Chain Reaction. An enzyme technology to amplify few copies of DNA piece by several orders of magnitude.
Pectin	A heteropolysaccharide in the cell wall of different plants.
Pectinase	An enzyme complex digesting pectin.
Phosphatase enzyme	Enzymes liberating phosphate group from its chemical bonds.
Positive stain	A stain that bounds to different compounds of bacterial cells.
Pour-plate technique	With this method, the sample, e.g. bacterial suspension is mixed and distributed in the melted agar medium, and then the agar is poured into empty Petri plates and allowed to solidify. This is followed by the incubation.
Primary metabolite	Substances produced by microbial cells, necessary for multiplication and produced in the trophophase (intensive growth phase) of microorganisms.
Pure culture	A culture comprised of cells originating from the same mother cell. Most often originating from a mixed culture.
RAPD	Random Amplification of Polymorphic DNA. A type of PCR reaction for genome wide typing of e.g. microorganisms using short arbitrary primers.
Replica-technique	A technique in which a copy is made from a Petri-plate culture using velvet fixed on solid cylinders.
Resolution of a microscope	The minimum distance between two separate points in a microscope's field of view, which can still be distinguished. The front lens of the objective is responsible for it.
Respiration	A biological energy (ATP) generating electron transport chain where electrons derive from and pass on extrinsic terminal electron donor/acceptor molecules.
Restriction enzyme	Endonuclease enzymes cutting DNA at restriction sites, at specific recognition nucleotide sequences.
Secondary metabolite	Non-essential substratances produced by microbial cells during the idiophase (this follows the intensive growth-phase, the trophophase, when slow or even no growth is characteristic) of their growth.
Selective medium	A growth medium that contains chemical substrate(s) inhibits or selectively enhances the growth of certain microbes or special groups.
Semisolid medium	A growth medium that contains only a small amount of gelling agent (e.g. 5-10g/L of agar-agar).
Serial dilution	A uniform, stepwise dilution of a substance e.g. soil or water sample in a solvent e.g. in distilled water or physiological saline.
Simple stain	Staining of fixed smear is performed with only one dye. The stained components of a cell in the microscope have the same colour.
Solid medium	A growth medium that is solidified with any gelling agent e.g. with 15-25 g/L of agar-agar.

WORKING DEFINITIONS

Spherical aberration	An optical effect observed in optical devices , originating from the fact that light beams around the optical axis, and at the edge of the field focus in different points. This gives a blurred image.
Spread-plate technique	A method in which a substrate e.g. diluted soil or bacterial suspension is spread onto the surface of an agar plate medium.
SRB	Sulphate-reducing bacteria. In the strict sense they use sulphate as terminal electron acceptor during anaerobic respiration. Sensu lato anaerobic respiring bacteria using inorganic sulphur compounds as electron acceptor.
Sterilisation	Any process that removes or kills all forms of microbial life, including the survival forms (e.g. endospores, cysts, etc.) of different microbes (bacteria, fungi, viruses, etc.).
Subculturing	The passage of microbial culture to a new medium.
Synergism of compounds	It is the interaction of compounds e.g. antibiotics when their combined effect is greater than their individual ones.
Synthetic medium	A growth medium, which is composed of chemically defined compounds.
TSI (Triple Sugar Iron) medium	Multitest medium containing three different type sugars, sodium thiosulphate, ferrous ions and pH indicator (phenol red), to test the ability of fermentation and H ₂ S production of enteric bacteria.
Tyndallisation	A method of intermittent sterilisation, lowering the germ count of a material.
VBNC	Viable But Non-Cultivable microorganisms.
Vegetative mycelium	Synonyme of substrate mycelium, hyphae growing into the medium to absorb nutrients.
Virus plaque	Lysis zone, regions of cell destruction in the growing cell lawn (of bacterial/ other cells).
Water activity	Refers to the free water content of a given substrate.
Wet heat sterilisation	The processes when the sterilisation is carried out with wet heat, e.g. in an autoclave.
Winogradsky column	A microcosm to enrich different microorganisms, including phototrophic microorganisms. A column of mud enriched with cellulose and gypsum (CaSO ₄) and placed in diffuse light at room temperature for longer periods (2-10 months). Colour changes refer to growth of different microbes.
Xerophilic microbes	Microbes growing well at small amounts of free water (low water activity). They can survive well in dry conditions.
Ziehl-Neelsen stain	A complex, differential bacteriological stain used to identify acid-fast bacteria.

Chapter 16. REVIEW QUESTIONS

REVIEW QUESTIONS ABOUT MICROBIOLOGICAL LABORATORY AND LABORATORY SAFETY

Select the appropriate letter to indicate whether the statement is true (T) or false (F)

T	F	1. Aerosol inhalation or airborne transmission of a microorganism is of prime concern at safety level categorisation.
T	F	2. BSL 1 organisms spread by percutaneous infection.
T	F	3. BSL 2 organisms are transmitted by ingestion.
T	F	4. BSL 2 organisms do not cause human disease in healthy individuals.
T	F	5. BSL 1 organisms spread with aerosols.
T	F	6. Microorganisms do not have hazardous metabolic products.
T	F	7. Droplet nuclei are formed from aerosol particles adhered to surfaces.
T	F	8. Aerosol formation is common during the use of disposable inoculating loops.
T	F	9. The mere opening of a Petri plate culture is a harmless action.
T	F	10. All endospore forming bacteria are highly infectious.

T	F	1. Primary containment is the protection of laboratory environment from contamination.
T	F	2. A biological safety cabinet is part of the secondary containment.
T	F	3. Personal protective equipment involves gloves.
T	F	4. In microbiological laboratories, only rubber surgical gloves are used.
T	F	5. Rubber surgical gloves provide protection from the chemical hazards present in a microbiological laboratory.
T	F	6. Laboratory doors open into the laboratory to help get into.
T	F	7. Air conditioning systems are forbidden to use in microbiological laboratories.
T	F	8. Laboratory design is a mere question of aesthetics.
T	F	9. Laboratory design is a substantial part of the secondary barrier system.
T	F	10. Instruments for terminal sterilisation must be present in each laboratory.

REVIEW QUESTIONS

T	F	1. Biological safety cabinets protect the operator and the procedure.
T	F	2. Only class 2 and 3 BSCs protect the procedure.
T	F	3. Class 2 BSCs are ducted.
T	F	4. All HEPA filters produce sterile air.
T	F	5. HEPA filters give adequate chemical safety.
T	F	6. Horizontal flow laminar air systems are adequate to microbiological laboratories.
T	F	7. Laminar airflow helps the use of gas burners.
T	F	8. Exhaust air of biological safety cabinets never goes back to the laboratory.
T	F	9. Fresh air enters the class 2 BSCs through a HEPA filter.
T	F	10. Fresh air enters the class 1 BSCs through a HEPA filter.

T	F	1. In a microbiological laboratory, the workbench should be decontaminated only following work.
T	F	2. Contact lenses should be changed to eyeglasses in the laboratory.
T	F	3. Persons wearing contact lenses should wear eye protection.
T	F	4. Protective clothing should be washed at home before the microbiological practices.
T	F	5. Mouth pipetting is forbidden in BSL 2 laboratories.
T	F	6. Diluted household bleach is used to decontaminate biological spills.
T	F	7. During hygienic handwash, first perform washing hands with soap, and then disperse the disinfectant on your hands.
T	F	8. During hygienic hand wash, first perform disinfection, and thereafter wash your hands with soap.
T	F	9. In microbiological laboratories, emergency shower is not needed.
T	F	10. The emergency phone number of the fire brigade in Hungary is 105.

T	F	1. The microbiological laboratory first-aid kit contains meat extract powder.
T	F	2. Boric acid solution is used to neutralize alkali following rinsing the skin with water.
T	F	3. Borax solution is used to neutralize alkali following rinsing the skin with water.

REVIEW QUESTIONS

T	F	4. Chemicals can cause skin burns.
T	F	5. Human blood needs adequate decontamination before ordinary cleaning.
T	F	6. Pulse is checked on the neck on the side of the Adams' apple.
T	F	7. Never check pulse on the neck!
T	F	8. Breathing is checked by listening for breathing sounds and observing chest movements.
T	F	9. A semiautomatic defibrillator apparatus can be used only by trained personnel.
T	F	10. In case you burn your fingers, simply hold your hand under running cold water first.

EXERCISES 1-3

Write the appropriate letter in front of the statement.

A	Sterilisation
B	Disinfection
C	Both
D	Neither

	1. This process kills or eliminates all forms of life from a medium or material.
	2. This process reduces bacterial populations in heat-sensitive liquid foods.
	3. This process eliminates nearly all pathogens from inanimate objects or surfaces.
	4. A treatment that makes an object or inert surface safe to handle.
	5. This process can be carried out using heat, radiation, filtering or chemicals.
	6. During this process, the used antimicrobial agents can cause -static or -cidal effects.
	7. During this process, liquids or gases are pressed through a filter, which retains or adsorbs microbes.
	8. During this process, antiseptic and/or disinfectant chemicals are applied.
	9. Several factors may affect the efficiency of this process.
	10. The control of the efficiency of this procedure happens by using chemical or biological indicators.

Select the appropriate letter to indicate whether the statement is true (T) or false (F).

T	F	1. Autoclave is a closed machine that allows the entrance of steam under pressure.
T	F	2. Autoclave is a dry-heat sterilising equipment.

REVIEW QUESTIONS

T	F	3. The autoclave is a powerful tool for sterilising microbiological culture media.
T	F	4. Using an autoclave is a rapid and dependable method for the sterilisation of heat-sensitive materials (e.g. sugars, antibiotics).
T	F	5. During sterilisation, air is expelled from the chamber of the autoclave and only steam remains.
T	F	6. In an autoclave, sterilisation takes place in a closed chamber at 121°C and 1.1 kg/cm ² overpressure.
T	F	7. In an autoclave, items are sterilised by exposure to 160-170°C for 2 hours.
T	F	8. The time used for sterilisation depends on the size and content of the load.
T	F	9. Chemical and biological indicators are available to monitor the efficacy of the sterilisation equipment.
T	F	10. The spores of <i>Geobacillusstearothermophilus</i> are biological indicators as they resist 121°C temperatures for longer than 15 minutes.

EXERCISES 4-11

Select the appropriate letter to indicate whether the statement is true (T) or false (F).

T	F	1. The sampling mode is determined by the purpose of the microbiological study.
T	F	2. Irrespective of the type of sampling, the samples always have to be representative.
T	F	3. Irrespective of the type of sampling, the samples always have to be individual.
T	F	4. Samples always have to contain a suitable number of equivalents.
T	F	5. Samples always have to contain a suitable number of parallels.
T	F	6. The heterogeneity of the sampling sites should be ignored.
T	F	7. Sampling always must be done with clean and sterile equipment.
T	F	8. The volume of the samples should be adequate for every required analysis.
T	F	9. Samples should be uniquely identified and labelled before or just after sampling.
T	F	10. The transfer of samples to the laboratory requires adequate precautions.
T	F	11. The time required to transfer the samples to the laboratory should be minimized.
T	F	12. Samples should be kept cool (5±3°C) during transportation.
T	F	13. Samples should be kept deep-frozen (-96°C) during transportation.
T	F	14. Laboratory examinations should ideally be started within the sampling day.
T	F	15. The Koch-type passive sedimentation method is the simplest way of air sampling.

REVIEW QUESTIONS

T	F	16. In highly contaminated environments, impaction techniques are the most appropriate methods for air sampling.
T	F	17. Volumetric air-samplers measuring and controlling the air inflow are usually used in industry.
T	F	18. The RCS Plus equipment is a strict flow cascade impactor, where air flows over a perforated sheet.
T	F	19. The RCS Plus equipment applies centrifugal impact that produces airflow directed to special medium-containing plastic test strips.
T	F	20. Water taps should be sterilised by flaming before sampling in order not to contaminate the sample from any outer surface.
T	F	21. Before water sampling, open the tap at maximum flow for 2-5 minutes.
T	F	22. A sterile Erlenmeyer-flask closed with a cotton plug is the most adequate means to collect surface phytoplankton samples.
T	F	23. Seasonal patterns and vertical stratification should be taken into consideration when choosing sampling sites.
T	F	24. Spatial heterogeneity should not be taken into consideration when choosing sampling sites.
T	F	25. Sampling of objects and surfaces always require special sampling equipment depending on the sampling site.

EXERCISE 12

Select the appropriate letter to indicate whether the statement is true (T) or false (F).

T	F	1. Microscope is one of the most important tools due to the micrometre-order-of-magnitude of microorganisms.
T	F	2. A bright-field light microscope is a multiple optical system.
T	F	3. In a microscope, the test object is positioned between the single and double focal points of the ocular.
T	F	4. The light from the object passes through the lens and creates a magnified, inverted and real image of the subject behind the double focal point.
T	F	5. The eyepiece is at a distance from the ocular lens so that the image formed by the objective is generated within the focal point of the objective.
T	F	6. Looking through the ocular, a further enlarged, direct but virtual image of the real, inverted and magnified image can be seen.
T	F	7. The magnifying power of a bright-field microscope can be calculated by multiplying the magnification of the objective and that of the eyepiece.
T	F	8. The first lens of the ocular multiple lens system is the front lens.
T	F	9. The front lens determines the magnification and resolution of the microscope.

REVIEW QUESTIONS

T	F	10. Other optical elements than the front lens of an objective are responsible for the elimination of lens errors (e.g. spherical and chromatic aberrations).
T	F	11. Chromatic aberration is caused when the lens away from the optical axis breaks the light rays passing through it to a greater degree.
T	F	12. The reason for chromatic aberration is that the focal points of different wavelengths of light do not coincide on the optical axis.
T	F	13. In the case of spherical aberration, a point-like object in the image will be blurred at the edge.
T	F	14. The resolving power is quantified with the minimum distance between two points that are just distinguishable.
T	F	15. The resolution (d) depends on the illumination wavelength of light used (λ), the half-angle of the aperture of the objective lens (α) and the refractive index of the material between the front lens and the cover slip (n).
T	F	16. The greater the resolution, the smaller the wavelength light of the illumination (λ).
T	F	17. The greater the resolution, the smaller the value of the half-angular aperture of the objective lens (α).
T	F	18. The greater the resolution, the smaller the value of the refractive index of the material between the front lens and the cover slip (n).
T	F	19. Greater resolution can be achieved by reducing the refractive index of the material between the front lens and the cover slip.
T	F	20. The fine structure of an image is determined by the resolution of the objective.
T	F	21. Specimens that absorb light of one colour and subsequently emit light of another colour (fluoresce) can be visualised by using the fluorescence microscope.
T	F	22. Fluorescence microscopy is based on the removal of incident illumination by selective absorption, where light absorbed by the specimen and re-emitted at another wavelength is transmitted.
T	F	23. The effective wavelengths light source of that are able to excite the fluorochrome are removed by an excitation filter.
T	F	24. A second excitation filter removes the incident wavelength from the beam of light absorbed by the specimen.
T	F	25. Wet mount preparation is a suitable means of examination of microorganisms inhabiting natural waters by bright-field light microscopy.

EXERCISES 13-14

Select the appropriate letter to indicate whether the statement is true (T) or false (F).

T	F	1. Special counting chambers cannot be used for counting cell numbers in liquid samples.
T	F	2. Special counting chambers can be used for counting cell numbers in dried samples.

REVIEW QUESTIONS

T	F	3. Direct microscopic counting is a quick method to estimate microbial cell numbers.
T	F	4. The slides of a counting chamber are grooved with squares of known area.
T	F	5. The number of cells in a unit area of a grid can be counted under the microscope.
T	F	6. The size and shape of grids can be different to suit the aim of the analysis.
T	F	7. The number of cells in a small volume can also be calculated, because the height of the liquid column over the grid is also known.
T	F	8. Fluorescent dyes (e.g. DAPI, 4',6-diamidino-2-phenylindole) can also be used to enumerate bacteria in different samples.
T	F	9. Using a fluorescent dye, cells are stained bright blue because the dye forms a complex with the cell's DNA.
T	F	10. Dead cells can be distinguished from living cells by using a fluorescent dye for cell count determination.

EXERCISES 15-18

Write the appropriate letter in front of the statement.

A	Spread-plate technique
B	Pour-plate technique
C	Membrane filter technique
D	MPN technique
E	All of the above
F	None of the above

	1. This technique is suitable for the enumeration of viable cell count of a sample.
	2. This technique is suitable for direct cell count determination of a sample.
	3. This technique is based on the cultivation of microorganisms present in a sample.
	4. This technique does not require the dilution of the samples.
	5. This technique is suitable for germ count estimation of a sample.
	6. This technique requires an incubation period following sample processing.
	7. This technique is not suitable for the calculation of CFU values per sample volume or mass.
	8. This technique is widely used in food, dairy, medical and environmental microbiology.
	9. This technique is suitable for the comparison of the number of microbes of a specific physiological group from different habitats.

REVIEW QUESTIONS

10.	The result of this technique depends on the composition of the medium used.
11.	The result of this technique depends on incubation time and temperature.
12.	This technique is based on the assumption that each cell of a sample is able to multiply during cultivation.
13.	This technique is based on the use of parallel liquid media inoculated with a known volume of different dilutions of the sample.
14.	This technique is an end-point dilution method.
15.	In this technique, a volume of 0.1 ml from a dilution series is distributed over the surface of an agar plate.
16.	In this technique, a known volume of sample is filtered through a membrane filter and is placed over the surface of the agar in a Petri plate.
17.	In this technique, a volume of 0.1 ml from a dilution series is <i>pipetted into a Petri-dish, and then agar medium is poured over it.</i>
18.	Only liquid sample can be examined with the use of this technique.
19.	This technique presumes that there is detectable grth even if only one viable microbial cell is present in the tube/well.
20.	The viable count obtained by this technique is less than the total cell number in a sample.

EXERCISE 19

Select the appropriate letter to indicate whether the statement is true (T) or false (F).

T	F	1. Production of sauerkraut is based on alcoholic fermentation, which exploits microbial enzyme activities.
T	F	2. As a first step of sauerkraut production, salt is added to raw cabbage to draw out much of the water.
T	F	3. The starting communities of sauerkraut production involve species of <i>Leuconostoc mesenteroides</i> , <i>Lactobacillus brevis</i> and <i>Lactobacillus plantarum</i> .
T	F	4. Salt-tolerant mixed-acid fermenting bacteria increase the pH of the sauerkraut.
T	F	5. Sauerkraut production utilises the indigenous bacterial population of raw cabbage.
T	F	6. The lactic acid fermentation of raw cabbage generates a low pH environment.
T	F	7. Mixed-acid fermenting bacteria (members of Enterobacteriaceae) produce alcohol.
T	F	8. Mixed-acid, heterolactic and homolactic fermentations take place during sauerkraut production.
T	F	9. The characteristic sour flavour of the sauerkraut originates from lactic acid.
T	F	10. The fermentation period of sauerkraut takes 6-8 days.

EXERCISES 20-21

REVIEW QUESTIONS

Select the appropriate letter to indicate whether the statement is true (T) or false (F).

T	F	1. Pectins are complexes of large polysaccharide molecules made up of several hundred galacturonic acid residues.
T	F	2. Pectins are complexes of large lipid molecules made up of several hundred glucuronic acid residues.
T	F	3. Pectinase enzymes help to soften the bacterial cell walls.
T	F	4. Pectinase enzymes help to soften the plant cell walls.
T	F	5. Pectinase enzymes help to soften the fungal cell walls.
T	F	6. Production of pectinases is limited to plant pathogen microorganisms.
T	F	7. <i>Erwinia carotovora</i> is a Gram-negative, rod shaped pectinase-producing bacterium.
T	F	8. Polygalacturonase is a widely used commercial pectinase.
T	F	9. Bacterial soft rots are caused by the phytopathogen <i>Erwinia carotovora</i> .
T	F	10. Pectin digesting spore-forming bacteria (e.g. <i>Clostridium</i> spp.) may occur in soils.

EXERCISES 22-25

Select the appropriate letter to indicate whether the statement is true (T) or false (F).

T	F	1. Culture media used in laboratories are nutrient solutions that allow microorganisms to multiply or survive.
T	F	2. The nutritional requirement of a microorganism determines the composition of the medium used for culturing.
T	F	3. The survival and growth of microorganisms do not depend on available and favourable growth environment.
T	F	4. A microbiological medium contains H-donors and acceptors as well as carbon source from 1 to 15-20 g/L.
T	F	5. Microbiological culture media contain inorganic compounds as growth factors.
T	F	6. Vitamins are the most frequently required growth factors.
T	F	7. Microbiological culture media may be classified according to their consistency, composition and function.
T	F	8. The physical forms of microbiological media are liquid (broth), semisolid and solid media.
T	F	9. A liquid medium does not contain any solidifying agent.
T	F	10. A semisolid medium contains gelatine (1-2 g/L) as solidifying agent.
T	F	11. A solid medium contains agar (10-20 g/L) as solidifying agent.

REVIEW QUESTIONS

T	F	12. Liquid media can be used to multiply large numbers of microorganisms in fermentation studies and for various biochemical tests.
T	F	13. Solid media can be used in fermentation studies, in determining bacterial motility, and in promoting anaerobic growth.
T	F	14. Solid media are used to determine colony morphology, isolate cultures, enumerate and isolate bacteria and for the detection of specific biochemical reaction.
T	F	15. Chemically defined media are called synthetic media.
T	F	16. Complex media are composed of known amounts of pure chemicals.
T	F	17. Undefined media are composed of a number of highly nutritious but chemically unpurified substances.
T	F	18. Commercially available digests of casein, beef, soybeans and yeast cells are common components of complex media.
T	F	19. Enrichment media do not contain any special additives and they are intended to support the growth of most bacteria.
T	F	20. All-purpose media are rich in vitamins and nutrients and promote the growth of most bacteria.
T	F	21. Enrichment media promote the growth of a particular microorganism against others by its specific nutrient utilisation ability or other unique metabolic properties.
T	F	22. Selective media enhance the growth of certain organisms while inhibit others due to the inclusion of particular substrate(s).
T	F	23. Differential media allow identification of microorganisms usually through their unique (and visible) physiological reactions.
T	F	24. If a medium in the test tube is allowed to solidify in a slanted position, the tube is named an agar deep tube.
T	F	25. If a medium is poured into a Petri dish, it is named an agar plate.

EXERCISE 26

Select the appropriate letter to indicate whether the statement is true (T) or false (F).

T	F	1. The Winogradsky column is a microcosm, which models the microbial processes taking place primarily in freshwater lake benthic environments.
T	F	2. The Winogradsky column is traditionally used to enrich purple and green phototrophic and other anaerobic bacteria.
T	F	3. The Winogradsky column is a small ecosystem of bacteria involved mainly in the nitrogen cycle.
T	F	4. The Winogradsky column is prepared by filling a glass measuring cylinder with mud rich in organic substances and containing sulphide.

REVIEW QUESTIONS

T	F	5. As the first step, 100 to 200 g of sieved garden soil is mixed with shredded filter paper as supplementary carbon source.
T	F	6. Thereafter, the soil is supplemented with calcium carbonate and calcium sulphate as buffer and a source of sulphate.
T	F	7. To avoid the forming of air bubbles, lake mud has to be filled into the column carefully.
T	F	8. In order to facilitate the enrichment of aerobic phototrophic bacteria, the column must be exposed to direct sunlight.
T	F	9. After 4-6 weeks of incubation period, a mixture containing many different types of bacteria visible with the naked eyes develops.
T	F	10. Sulphate-reducing phototrophic bacteria can be seen as purple and green patches near the mud-water interface.

EXERCISES 27-28

Write the appropriate letter in front of the statement.

A	Isolate
B	Pure culture
C	Both
D	Neither

1.	At making this culture, bacterial cells from a discrete colony developed on the surface of an agar plate are transferred to an agar slant.
2.	This type of culture can be obtained by the streak-plate technique.
3.	Co-multiplication of two or more microbes may occur in this type of culture.
4.	Inoculating needles or loops are used to produce this type of culture.
5.	This type of culture is cultivated on agar slant.
6.	The microbiological examination of this type of culture generally provides confusing and misleading results.
7.	This type of culture is free from other microorganisms; develops from a single cell or colony forming unit.
8.	This type of culture is not necessarily derived from a single mother cell/a clone of cells.
9.	This type of culture serves as the basis of species-level identification of bacteria and other studies.
10.	The maintenance of this type of culture over a long period requires subculturing.

EXERCISES 29-32

Select the appropriate letter to indicate whether the statement is true (T) or false (F).

REVIEW QUESTIONS

T	F	1. Bacteria are sensitive to oxygen concentration and/or redox value within the media or the surrounding atmosphere.
T	F	2. Microorganisms that grow only in the presence of oxygen are called obligate aerobes.
T	F	3. Microorganisms that cannot use oxygen but are not harmed by it are called facultative aerobes.
T	F	4. Microorganisms that grow either in the presence or in the absence of oxygen, but better in its presence, are called facultative anaerobes.
T	F	5. Microorganisms that grow only in the absence of oxygen and are harmed by its presence are called obligate anaerobes.
T	F	6. Microorganisms that require a small amount of oxygen for normal growth but are inhibited by oxygen at normal atmospheric pressure are called aerotolerant anaerobes.
T	F	7. One of the most convenient approaches to culture anaerobic bacteria is the use of thioglycollate medium.
T	F	8. Thioglycollate medium contains methylene blue or resazurin as redox indicator.
T	F	9. The colour of the indicator begins to turn bluish or reddish when the medium is becoming reducing.
T	F	10. Deep agar tubes prepared with a small amount of agar are also applicable for the cultivation of anaerobes.
T	F	11. The agar content of deep agar tubes can facilitate convection currents in the tubes and exhibits an oxidative effect.
T	F	12. Oxidative compounds (e.g. sodium thioglycollate or cysteine) can be used to raise the redox potential in semisolid media.
T	F	13. Anaerobic bacteria can be cultivated in special Petri dishes called Marino-plates without the use of elaborate and expensive incubators.
T	F	14. Marino-plates provide a relatively large surface to examine the colonies of anaerobic bacteria and also make isolation easier.
T	F	15. In the case of the Marino-plates, the bottom of a normal Petri dish sits on its cover containing the agar in a way that its circular ridge protects most of the surface from the exposure to oxygen.

Write the appropriate letter in front of the statement.

A	Anaerobic jar
B	Anaerobic chamber
C	Both
D	Neither

	1. This device is suitable to safely inoculate, incubate, examine and subculture even the most fastidious anaerobic microorganisms.
--	---

REVIEW QUESTIONS

	2. This device is suitable to cultivate microorganisms that are not sensitive to trace amounts of oxygen and are able to survive temporarily high oxygen concentrations.
	3. This device usually contains a disposable H ₂ +CO ₂ generator and a redox indicator.
	4. This device usually contains a palladium catalyst.
	5. This device usually contains activated carbon and a desiccant system.
	6. This device usually contains dry powder or pellets which, when mixed with water, produce an oxygen-free atmosphere.
	7. The pellets contain sodium borohydride, citric acid and sodium-hydrogen-carbonate that generate hydrogen and carbon-dioxide when they react with water.
	8. This device is equipped with glove ports, which connect to an oversized cultivation cabin.
	9. This device connects to the outside through a sluice chamber, which removes oxygen when materials are introduced into it.
	10. A sluice chamber allows the rapid transfer of materials into and out of this device.
	11. This device is filled with a mixture of gas suitable for the cultivation of anaerobic bacteria.
	12. This device usually contains trace amounts of oxygen.
	13. The palladium catalyst helps the formation of water from hydrogen and oxygen; thereby oxygen is removed from this device.
	14. Methylene blue becomes colourless if oxygen is present in this device.
	15. Cultures are placed into this device along with the palladium catalyst.

EXERCISES 33-34

Select the appropriate letter to indicate whether the statement is true (T) or false (F).

T	F	1. To select the appropriate technique of maintenance, one must take into account several factors (e.g. the aim of maintenance, intended duration, generation time of the microbes).
T	F	2. During subculturing, cultures of bacteria are transferred to a fresh sterile medium at appropriate intervals, and the newly developed cultures are stored at 4-6°C.
T	F	3. The procedure of subculturing should be repeated periodically (every few weeks or months) depending on the characteristics of the bacterial strains.
T	F	4. The advantage of subculturing is that cultures are prevented from desiccation during storage.
T	F	5. The disadvantage of subculturing is that cultures are exposed to contamination and are prone to mutations.
T	F	6. A subcultured agar slant can be covered with paraffin in order to ensure anaerobic conditions for a relatively long period of time.

REVIEW QUESTIONS

T	F	7. The so called “dry maintenance” technique means that free available water is removed from the culture and water uptake is not allowed during storage.
T	F	8. The “dry maintenance” technique involves the procedures of subculturing, freezing and lyophilisation.
T	F	9. During the process of freezing, microbial cells become hydrated, and the formation of ice crystals can preserve their viability for many years.
T	F	10. During the process of freezing, cryoprotective substances (e.g. dimethyl sulfoxide and glycerol) increase the concentration of electrolyte solution within the microbial cells.
T	F	11. Freezing techniques can be classified according to the employed temperature.
T	F	12. Freeze storage above -30°C is effective especially for fungi.
T	F	13. A wide variety of prokaryotes can be stored by deep-freezing at -70°C for many years.
T	F	14. Lyophilisation called also as freeze-drying is one of the oldest procedures used to maintain the viability of microorganisms even for decades.
T	F	15. The initial step of lyophilisation is that a bacterial culture is suspended in a sterile solution of some cryoprotective agents (e.g. blood serum, inositol, sucrose, raffinose).
T	F	16. The second step of lyophilisation is that ice is sublimated under high vacuum so the suspension cannot melt during the process of drying.
T	F	17. The third step of lyophilisation is that small amounts of the thick suspension are transferred to vials and then quickly frozen.
T	F	18. The basic parts of a freeze-drying equipment are a vacuum pump and a chamber with a cooled wall to condense water.
T	F	19. During the freeze-drying process, samples are centrifuged to minimise the surface for evaporation and to facilitate gas emissions.
T	F	20. During lyophilisation, CoCl_2 crystals are used to indicate the presence of water by the changing colour.

EXERCISE 35

Select the appropriate letter to indicate whether the statement is true (T) or false (F).

T	F	1. A colony is a large number of bacterial cells on a solid medium, which is visible to the naked eye as a discrete entity.
T	F	2. <i>A colony may derived from different mother cells, therefore cannot be considered as genetically identical cell mass of microorganisms.</i>
T	F	3. The number of cells within a colony can even reach a few billion.
T	F	4. <i>The general properties of a colony (e.g. size, shape, elevation, margin, pigmentation, surface, density, consistency) can be characteristic to a particular bacterial strain.</i>

REVIEW QUESTIONS

T	F	5. The medium composition does not influence the general properties of a colony in case of a particular bacterial strain.
---	---	---

EXERCISE 36

Select the appropriate letter to indicate whether the statement is true (T) or false (F).

T	F	1. A bacterial smear is a dried preparation of bacterial cells on a glass slide.
T	F	2. A smear can be prepared from either a broth culture or an agar slant or plate by spreading the bacterial cells on the surface of a slide.
T	F	3. In an appropriate smear, bacteria are adequately separated from one another.
T	F	4. The procedure of smear preparation is necessary to avoid bacterial cells being washed off the slide during staining.
T	F	5. Most bacteria can be fixed to the slide and killed by heat-fixing, while bacterial cells are distorted.
T	F	6. Dyes used for microbiological staining procedures could be acidic, basic and neutral according to their chemical characteristics.
T	F	7. The coloured part of dye molecules is always neutral.
T	F	8. The chromophore of acidic dyes has a negative charge; therefore, bacterial cells reject these dyes.
T	F	9. The chromophore of basic dyes has a positive charge, which binds to proteins and nucleic acids of bacterial cells.
T	F	10. Positive staining results in the staining of bacterial cells.
T	F	11. Positive staining is also called background staining.
T	F	12. Negative staining is also called simple staining.
T	F	13. Negative staining is performed with dyes that do not penetrate the bacterial cells.
T	F	14. Positive staining produces a deposit or a dark background around the bacterial cells.
T	F	15. Simple staining will be performed with only one dye.

EXERCISE 37-38

Select the appropriate letter to indicate whether the statement is true (T) or false (F).

T	F	1. Gram staining is named after Christian Gram, Danish scientist and physician.
T	F	2. The Gram staining procedure is based on the cell wall structure of bacteria.
T	F	3. Gram staining is an important staining procedure from taxonomic point of view.
T	F	4. Gram staining is a useful and widely employed differential stain in bacteriology.

REVIEW QUESTIONS

T	F	5. Gram staining is a useful and widely employed structural stain in bacteriology.
T	F	6. During the first stain of the procedure of Gram staining, basic dyes are used.
T	F	7. During the second stain of the procedure of Gram staining, acidic dyes are used.
T	F	8. The first stain of the procedure of Gram staining is called positive staining.
T	F	9. The second stain of the procedure of Gram staining is called counterstaining.
T	F	10. Bacteria with a Gram-negative cell wall structure can be easily decolourised with organic solvents after the primary stain.
T	F	11. Bacteria with a Gram-positive cell wall structure can be easily decolourised with organic solvents before the counterstain.
T	F	12. Gram staining always brings a clear result; therefore, bacteria can be divided into two groups (Gram-positives and Gram-negatives).
T	F	13. The Japanese Gram-test is an easy and quick method to distinguish bacteria with Gram-positive and Gram-negative cell walls.
T	F	14. The Japanese Gram-test is based on the fact that strong acids destroy the homogenous Gram-positive cell walls and a thin filament can be pulled from the disengaged DNA.
T	F	15. The Japanese Gram-test is based on the fact that strong bases destroy the structure of Gram-negative cell walls and a thin filament can be pulled from the disengaged DNA.

Write the appropriate letter in front of the statement.

A	Gram-positive bacteria
B	Gram-negative bacteria
C	Both
D	Neither

	1. These bacteria show the colour of the primary stain of crystal violet.
	2. These bacteria show the colour of the primary stain of methylene blue.
	3. These bacteria can be easily decolourised with organic solvents.
	4. These bacteria can be easily decolourised with tap water.
	5. These bacteria retain the primary stain after decolourisation.
	6. These bacteria lose the primary stain after decolourisation.
	7. These bacteria show the colour of the counterstain of safranin.
	8. These bacteria are deep purple in colour.

REVIEW QUESTIONS

9. These bacteria are pinkish to red in colour.
10. The staining results of the ageing cultures of these bacteria may change.

EXERCISES 39-41

Write the appropriate letter in front of the statement.

A	Spore staining
B	Acid-fast staining
C	Capsule staining
D	All of the above
E	None of the above

1. This staining procedure is also called Leifson staining.
2. This staining procedure is also called Schaeffer-Fulton staining.
3. This staining procedure is also called Ziehl-Neelsen staining.
4. This staining procedure is a complex differential staining.
5. This staining procedure is a complex structural staining.
6. This staining procedure is a negative staining.
7. This staining procedure is a simple staining.
8. This staining procedure is a neutral staining.
9. This staining procedure serves the detection of bacteria containing mycolic acid in their cell wall.
10. This staining procedure serves the detection of glycocalyx around the bacterial cells.
11. This staining procedure serves the detection of highly resistant structures inside the bacterial cells.
12. This staining procedure serves the detection of storage materials inside the bacterial cells.
13. This staining procedure makes a distinction in retention of carbolfuchsin.
14. This staining procedure does not require a staining step with heating.
15. This staining procedure does not require a heat-fixing step.
16. This staining procedure requires a differential washing step with acidic-alcohol.
17. This staining procedure requires a washing step with tap water.

REVIEW QUESTIONS

	18. As a result of this staining procedure, bacterial cells can be stained to reddish-pink or blue.
	19. As a result of this staining procedure, bacterial cells can be stained to purple or pinkish-red.
	20. As a result of this staining procedure, bacterial cells cannot be stained.

EXERCISE 42

Select the appropriate letter to indicate whether the statement is true (T) or false (F).

T	F	1. A hanging-drop preparation is suitable to study bacterial motility in an aqueous environment by using a bright-field microscope.
T	F	2. A hanging-drop preparation is suitable to observe the general shape of live bacteria and the arrangement of bacterial cells by using a bright-field microscope.
T	F	3. A hanging-drop preparation is suitable to determine the type of bacterial flagellation by using a bright-field microscope.
T	F	4. Non-motile bacterial cells show Brownian motion resulting from bombardment by water molecules.
T	F	5. Bacteria with polar or peritrichous flagellation move definitely and continuously in a given direction.

EXERCISE 43

Select the appropriate letter to indicate whether the statement is true (T) or false (F).

T	F	1. The micromorphology of microscopic fungi and actinobacteria can be studied with the help of slide-cultures.
T	F	2. Slide-cultures are also called humidity chambers.
T	F	3. <i>Aspergillus</i> species form a bulb at the tip of the conidium holders and from each sterigma, the conidia branch off like a sweep.
T	F	4. <i>Streptomyces</i> species are microscopic fungi that produce hyphae/mycelia submerged into the nutrient solution or agar medium by using humidity chambers.
T	F	5. The conidium holders of <i>Penicillium</i> species branch off like brushes.

EXERCISE 44.

Select the appropriate letter to indicate whether the statement is true (T) or false (F).

T	F	1. Flavoproteins are molecules that carry electrons and protons.
T	F	2. Flavoproteins reduce molecular oxygen to hydrogen peroxide or superoxide.
T	F	3. Only a small amount of bacteria are able to protect themselves against the toxic intermediates produced in aerobic conditions.
T	F	4. Catalase is an enzyme that is produced by obligate aerobic and facultative anaerobic microbes.

REVIEW QUESTIONS

T	F	5. Aerotolerant anaerobic bacteria produce superoxide dismutase and catalase enzymes to survive in aerobic conditions.
T	F	6. Catalase enzyme prevents the accumulation of toxic levels of hydrogen peroxide by the catalysis of its breakdown to water and oxygen.
T	F	7. Hydrogen peroxide is toxic only to bacterial cells.
T	F	8. Hydrogen peroxide is a common by-product of metabolic reactions that take place in the presence of water and oxygen (related to the electron transport pathway).
T	F	9. All catalase-negative organisms are anaerobic, e. g. <i>Streptococcus</i> spp., <i>Lactobacillus</i> spp., <i>Clostridium</i> spp.
T	F	10. The catalase reaction of a bacterium can be demonstrated with the help of 10% hydrogen peroxide.

EXERCISE 45.

Select the appropriate letter to indicate whether the statement is true (T) or false (F).

T	F	1. Oxidase is an enzyme which oxidises different substrates.
T	F	2. Cytochrome oxidase is the final enzyme in the respiratory electron transport system of all bacteria.
T	F	3. Oxidase enzyme receives electrons and passes them onto oxygen, nitrate or nitrite as terminal electron acceptors.
T	F	4. <i>Pseudomonas</i> spp. and closely related bacteria produce cytochrome oxidase enzyme.
T	F	5. Members of the family Enterobacteriaceae lack oxidase enzyme.
T	F	6. To detect oxidase activity, a test strip with oxidase reagent must be used.
T	F	7. In the case of a positive test, oxidised cytochrome oxidises tetramethyl-p-phenylenediamine to form a red product within 30 seconds.
T	F	8. To evaluate the oxidase test, a platinum inoculating loop must be used as the ordinary inoculating loops can give false positive reaction due to the Fe ²⁺ ions that can interfere with the test reagent.
T	F	9. Gram-negative rods produce oxidase enzyme in their respiratory chain.
T	F	10. A sterile filter paper in an empty Petri dish can be impregnated with oxidase reagent to detect the purplish-blue product of tetramethyl-p-phenylenediamine.

EXERCISE 46.

Select the appropriate letter to indicate whether the statement is true (T) or false (F).

T	F	1. Methylene blue is a dye that can be used as alternative electron acceptor by different microbes.
T	F	2. Methylene blue can be an electron acceptor only when oxygen is not present.

REVIEW QUESTIONS

T	F	3. Methylene blue is colourless in the presence of oxygen.
T	F	4. To test the methylene blue reduction, anaerobic conditions are required.
T	F	5. The oxidised form of methylene blue is the colourless leuco-methylene blue.

EXERCISE 47-48.

Write the appropriate letter in front of the statement.

A	Casease enzyme
B	Gelatinase enzyme
C	Both
D	Neither

	1. An enzyme, which is involved in the degradation of a protein.
	2. Digests the protein of milk.
	3. Produces monomers from different biopolymers (e.g. nucleic acids, proteins).
	4. Cuts water-soluble mixtures of proteins.
	5. Enzyme, which contributes in the biopolymer degradation.
	6. Can degrade the extract of connective tissues and tendons of animals.
	7. Its activity is tested on a skim milk agar plate.
	8. Breaks down gelatine to utilizable fatty acids.
	9. To evaluate results, the incubated Petri plates must be flooded with acidic HCl solution, which denatures the remaining proteins and a clear zone around the colony becomes visible in case of a positive reaction.
	10. False positive reaction can be observed if this enzyme degrades casein only partially and produces paracasein.

EXERCISE 49.

Select the appropriate letter to indicate whether the statement is true (T) or false (F).

T	F	1. Amylase is an enzyme, which is responsible for the degradation of casein.
T	F	2. Starch is a polysaccharide, which is abundant in nature and is rich source of carbon and energy.
T	F	3. Starch is a common carbohydrate reserve supplying the nutritional need of plant roots.
T	F	4. Amylases cleave the small starch molecules into monosaccharides and disaccharides, which are able to cross bacterial cell walls or cell membranes.

REVIEW QUESTIONS

T	F	5. Amylase enzyme degrades amylose and also amylopectin.
T	F	6. The end products of starch degradation are the sugars which are small enough to penetrate the cell membranes and further degraded by endoenzymes inside the cells.
T	F	7. Amylase activity can be tested on agar plates containing skim milk.
T	F	8. Degradation of starch can be detected with the help of Lugol's solution after incubating for 24 hrs at 28°C.
T	F	9. Evaluation of the results is based on the reaction of starch with iodine, which gives a deep blue coloration.
T	F	10. Where amylase enzyme hydrolysed starch, a blue zone indicates the positive reaction.

EXERCISE 50.

Select the appropriate letter to indicate whether the statement is true (T) or false (F).

T	F	1. Lipids can be found in the cell membranes, and cell walls of bacteria and are also common nutrient storage compounds of all living organisms.
T	F	2. Triglycerides are of glycerol and fatty acids.
T	F	3. Esters can be hydrolysed by esterase enzymes inside the cells.
T	F	4. Lypolytic activity can be tested on agar plates containing Tween 80 .
T	F	5. Tween 80 is the oleic acid derivative of a polyoxyethylene sorbitan molecule.
T	F	6. To test esterase/lipase activity, a bacterial culture must be cross-inoculated onto the agar surface of a slant containing Tween 80 .
T	F	7. In the case of a positive reaction, the hydrolysis of Tween 80 frees fatty acids in the medium.
T	F	8. Calcium ions present in the medium form Ca-oleate precipitation zones around the inoculated area.
T	F	9. To evaluate data, acidic HgCl ₂ must be used, which precipitates the visible Ca-oleate crystals in the medium.
T	F	10. All bacteria have esterase/lipase activity.

EXERCISE 51.

Select the appropriate letter to indicate whether the statement is true (T) or false (F).

T	F	1. Nuclease is an enzyme, which digests DNA.
T	F	2. Certain microbes can use nucleic acids as energy and carbon source.
T	F	3. Nuclease activity can be tested on DNA-containing agar slants.

REVIEW QUESTIONS

T	F	4. To test DNase activity, 1N NaOH is needed as reagent after incubating the cultures at 28°C for one week.
T	F	5. If DNA has been hydrolysed, there will be a clear zone around the inoculated area after spreading the reagent on it.

EXERCISE 52-53.

Write the appropriate letter in front of the statement.

A	Hugh-Leifson test
B	Voges-Proskauer reaction
C	Both
D	Neither

	1. With this method, the carbohydrate metabolism of different bacteria can be tested.
	2. An oxidation-fermentation test, which is used to distinguish between fermentation and aerobic respiration.
	3. Test medium contains glucose.
	4. This test is applied to identify organisms able to produce aesculetin from aesculin.
	5. The test differentiates between members of the family Enterobacteriaceae.
	6. The test is evaluated in semisolid agar medium.
	7. As the test is suitable for the study of fermentation, the fermentative tube is sealed with a thick layer of sterile paraffin oil to prevent oxygen penetrating the medium.
	8. Enables the detection of acid production.
	9. Barritt reagent is needed to evaluate the result of the test.
	10. In a positive test reaction, the presence of acetyl-methyl-carbinol is detected in the test tube.

EXERCISE 54.

Select the appropriate letter to indicate whether the statement is true (T) or false (F).

T	F	1. Aesculin hydrolysis is a useful test in the differentiation of both Gram-positive and Gram-negative bacteria.
T	F	2. Hydrolysis is indicated by the production of yellowish precipitate in the test tube.
T	F	3. The hydrolysis product is aesculetin (4,5-dihydroxycoumarin).
T	F	4. The test is evaluated on aesculin-containing agar plate.

REVIEW QUESTIONS

T	F	5. The hydrolysis product (aesculetin) is combined with ferric ions, therefore the positive reaction is a black compound.
---	---	---

EXERCISE 55-56.

Write the appropriate letter in front of the statement.

A	H ₂ S production
B	Indole test
C	Both
D	Neither

	1. Tests the degradation of different amino acids.
	2. One of the end products in the test is pyruvic acid, which is subsequently metabolised.
	3. Tests the degradation of tryptophan.
	4. Pure tryptophan is used ordinarily in the test medium.
	5. The test is evaluated in broth medium containing a mixture of amino acids.
	6. Bacteria that produce the enzyme cysteine desulfhydrase are able to be tested with this method.
	7. At the end, a test is necessary to determine the presence of hydrogen sulphide and ammonia.
	8. Hydrogen sulphide reacts with heavy metals (e. g. lead or iron) to form a visible black precipitate and this indicates a positive result.
	9. Kovács' reagent is needed to check the result of the test.
	10. A positive test is indicated by a red colouration in the surface alcohol layer after adding the reagent to the test tube.

EXERCISE 57.

Select the appropriate letter to indicate whether the statement is true (T) or false (F).

T	F	1. Phosphatase enzyme liberates inorganic phosphate from its compounds.
T	F	2. Only a few microbes have phosphatase activity.
T	F	3. In food industry, the phosphatase test is often used to differentiate coagulase positive Streptococci, as this method is less time consuming.
T	F	4. The test is evaluated on Na-phenolphthalein-diphosphate agar plate.
T	F	5. Ammonia is needed to evaluate the results of the phosphatase test.

REVIEW QUESTIONS

EXERCISE 58.

Select the appropriate letter indicating whether the statement is true (T) or false (F).

T	F	1. The majority of bacterial pathogens produce erythrocyte destroying enzymes.
T	F	2. In the case of α -haemolysis, the erythrocytes are completely destroyed and bacterial colonies are surrounded by greenish-brownish zone.
T	F	3. In the case of β -haemolysis, the erythrocytes are partially destroyed and bacterial colonies are surrounded by a clear zone.
T	F	4. Haemolysis is tested on blood agar plates.
T	F	5. To detect haemolysine activity, blood serum is needed.

EXERCISE 59.

Select the appropriate letter to indicate whether the statement is true (T) or false (F).

T	F	1. Because of their selective effect, multitest media can be used for testing several enzymatic activities simultaneously.
T	F	2. Triple Sugar Iron (TSI) agar plates are generally used for the characterisation of Enterobacteria.
T	F	3. The intestinal pathogens <i>Salmonella</i> and <i>Shigella</i> ferment lactose and glucose, but not sucrose.
T	F	4. TSI medium contains 0-1% sucrose, 1.0% glucose and 1.0% lactose, ferrous sulphate and phenol red indicator.
T	F	5. Phenol red changes to yellow when the environment is alkaline.
T	F	6. The most common non-pathogenic faecal rods can ferment glucose.
T	F	7. TSI agar is slanted with a deep butt and should be inoculated with a special technique.
T	F	8. TSI agar medium must be inoculated with stab inoculation as well as zigzag streak inoculation.
T	F	9. To evaluate the results the colour of the slant and that of the stab culture must also be checked.
T	F	10. Black colouration in the stab culture indicates H ₂ S production from proteins.

EXERCISE 60.

Select the appropriate letter to indicate whether the statement is true (T) or false (F).

T	F	1. Temperature slightly influences the multiplication and metabolic processes of microbes.
T	F	2. The minimum temperature value of growth is where the microbe shows the lowest speed of multiplication.
T	F	3. The optimum value of temperature is where the speed of bacterial multiplication is optimal.
T	F	4. <i>Staphylococcus aureus</i> , <i>Escherichia coli</i> and <i>Geobacillus stearothermophilus</i> are mesophilic bacteria.

REVIEW QUESTIONS

T	F	5. Multiplication dynamics of bacteria can be studied under laboratory conditions, which always reflect the dynamics that can be observed in nature.
T	F	6. Psychrophilic bacteria can also live in mesophilic conditions, but their optimum is at lower temperatures.
T	F	7. Hyperthermophiles live at very high temperatures, as their optimum is always above 100°C.
T	F	8. <i>Thermus aquaticus</i> is a hyperthermophilic bacterium.
T	F	9. The effect of temperature on microbial gtrth can be tested after a heat shock.
T	F	10. The intensity of gtrth at different temperatures will indicate the effect of temperature on bacterial cultures.

EXERCISE 61.

Select the appropriate letter to indicate whether the statement is true (T) or false (F).

T	F	1. The temperature tolerance of bacteria can be tested on agar slants.
T	F	2. Gram-negative organisms are more sensitive than Gram-positive to a heat shock as Gram-positive bacteria often produce endospores, which are more resistant to heat.
T	F	3. The temperature tolerance of bacteria depends on the applied temperature, length of incubation after the treatment and other environmental factors.
T	F	4. The temperature tolerance can vary within species and not within strains of the same species.
T	F	5. During the testing of temperature tolerance, bacterial suspensions must be heat-treated in 60°C and 90°C water baths.

EXERCISE 62.

Select the appropriate letter to indicate whether the statement is true (T) or false (F).

T	F	1. Hydrogen ion concentration has the greatest influence on microbial gtrth.
T	F	2. pH is the $\log[H^+]$, which is the concentration of hydrogen ions.
T	F	3. The hydrogen ion concentration effects cell membrane permeability and activity of different enzymes.
T	F	4. Optimum pH value for a bacterium is the hydrogen ion concentration at which the bacterial gtrth is the most intensive.
T	F	5. Minimum and maximum hydrogen ion concentrations are pH values where an organism still shows gtrth.
T	F	6. Even when the composition of the medium changes, the pH requirements of a bacterium are unchanged.
T	F	7. Incubation temperature and osmotic pressure influence the pH requirements of a bacterium.
T	F	8. <i>Thiobacillus thiooxidans</i> is an acidophilic bacterium.

REVIEW QUESTIONS

T	F	9. <i>Escherichia coli</i> and <i>Bacillus alkalitolerans</i> are neutrophilic bacteria.
T	F	10. pH tolerance can be studied in nutrient broth culture.

EXERCISE 63.

Select the appropriate letter to indicate whether the statement is true (T) or false (F).

T	F	1. Only free, unbound water can be used by microorganisms for their metabolic processes.
T	F	2. Water activity is a measure of free water, which hardly supports biological and chemical reactions in a system.
T	F	3. The water activity of a solution is quantitatively equal to the vapour pressure of the solution divided by the vapour pressure of the solvent.
T	F	4. When solutes are added to water, molecules orient themselves on the surface of the solute and the properties of a solution change dramatically.
T	F	5. Microbial cells have to compete with solvent molecules for free water molecules.
T	F	6. Water activity varies a lot with the temperature of cultivation.
T	F	7. Water activity varies between 0.00 and 1.00, a solution of pure water has a water activity of 1.00, the addition of a solute decreases water activity to less than 1.00.
T	F	8. The water activity of different microbes differ strongly.
T	F	9. Xerophilic moulds need a water activity of at least 0.80.

EXERCISE 64.

Select the appropriate letter to indicate whether the statement is true (T) or false (F).

T	F	1. All microorganisms are sensitive to UV radiation.
T	F	2. The UV range covers a wide range of the electromagnetic spectrum (200-400nm).
T	F	3. Only a nartr range of the spectrum is responsible for germicidal effect.
T	F	4. A very strong bactericidal effect can be observed at a wavelength of 245 nm.
T	F	5. UV radiation damages the DNA, inducing the production of thymine dimers within the chain.
T	F	6. Pigmented bacteria are more resistant to UV radiation than those without pigments.
T	F	7. Bacterial endospores are resistant to UV radiation.
T	F	8. Effect of UV radiation is tested on agar slants during the practical.
T	F	9. The agar slant must be exposed to UV radiation for 10 min (under the UV lamp) and the effect is visible after one week of incubation at 28°C.

REVIEW QUESTIONS

T	F	10. It is possible to evaluate the germicidal effect based on the intensity of bacterial grth.
---	---	--

EXERCISE 65

Select the appropriate letter to indicate whether the statement is true (T) or false (F).

T	F	1. Lysozyme is a glycoside hydrolase enzyme responsible for the digestion of glycolipids.
T	F	2. Lysozyme can be found in large amounts in egg yolk.
T	F	3. Lysozyme is produced exclusively by bacteria.
T	F	4. Activity of lysozyme can be tested by the decrease of the optical density of a bacterial cell suspension.
T	F	5. The optical density of a cell suspension can be measured by a spectrophotometer.

EXERCISE 66-69

Select the appropriate letter to indicate whether the statement is true (T) or false (F).

T	F	1. Antibiotics are produced by microorganisms and possess the ability to kill or inhibit the grth of bacteria and other microorganisms at remarkably low concentrations.
T	F	2. All antimicrobial agents are suitable to affect a broad spectrum of microbes.
T	F	3. All antibiotics are produced by fungi.
T	F	4. Chemotherapeutic agents are chemicals that can be applied in therapeutics.
T	F	5. Chemotherapeutic agents applied at concentrations tolerated by the host, can interfere directly with the proliferation of a given microorganism.
T	F	6. Penicillin blocks protein biosynthesis.
T	F	7. Ampicillin is a broad-spectrum antibiotic against Gram-negative bacteria.
T	F	8. Streptomycin blocks cell wall biosynthesis.
T	F	9. Polymyxin B blocks membrane transport processes.
T	F	10. In the Kirby-Bauer method, paper discs containing a pre-determined concentration of an antimicrobial agent are placed onto the infected agar plate.
T	F	11. The sensitivity of a bacterium for an antimicrobial agent can be expressed as the size of the inhibition zone determined by the Kirby-Bauer method.
T	F	12. "Resistant" means that the organism is inhibited by a clinically attained concentration of the antimicrobial agent.
T	F	13. The addition of two or more antimicrobial agents to a microbial population sensitive to each of the individual compounds may have inhibitory effect.

REVIEW QUESTIONS

T	F	14. The Kirby-Bauer method is not suitable for measuring the synergy and antagonism of antimicrobial agents.
T	F	15. Some secondary metabolites produced by microorganisms have antimicrobial activity.
T	F	16. Antimicrobial activity can be tested with agar diffusion assay.
T	F	17. Some members of the genus <i>Streptomyces</i> produce antimicrobial compounds.
T	F	18. The detection of antagonism between microorganisms is possible by cross-streak experiments.

EXERCISE 70

Select the appropriate letter to indicate whether the statement is true (T) or false (F).

T	F	1. Bacteria cannot acquire resistance to antibiotics by horizontal gene transfer.
T	F	2. During the “replica-technique”, “copies” from discrete bacterial colonies that grew on the surface of a Petri plate are produced.
T	F	3. Based on the elevation of colonies, metabolic mutants, i.e. microbes with distinct properties can be retrieved by the “replica-technique”.

EXERCISE 71

Select the appropriate letter to indicate whether the statement is true (T) or false (F).

T	F	1. Many vascular plants produce chemical compounds that inhibit the growth of microorganisms.
T	F	2. Phytoncides may play an important role in the resistance of vascular plants to pathogenic bacteria.
T	F	3. Most plants produce similar antimicrobial compounds.
T	F	4. No herbs contain antimicrobial compounds.
T	F	5. Placing slices of plant tissues onto infected agar plates may be useful to test the antibacterial effect of these plants.

EXERCISE 72

Select the appropriate letter to indicate whether the statement is true (T) or false (F).

T	F	1. Heavy metal ions are toxic for microorganisms only at high concentrations.
T	F	2. The antimicrobial effect of heavy metal ions is caused by the damage to bacterial cell membranes.
T	F	3. CuSO_4 solution has a toxic effect on microbes.

EXERCISE 73.

Select the appropriate letter to indicate whether the statement is true (T) or false (F).

REVIEW QUESTIONS

T	F	1. Chemotaxonomy deals with the chemical variability present in living organisms.
T	F	2. With chemotaxonomical methods, it is not possible to study the taxonomically relevant features of nucleic acids but the characteristic carbohydrates, and the lipid components of microbes.
T	F	3. Chemotaxonomical methods are widely used for studying the microbial diversity of various habitats.
T	F	4. Isoprenoid quinones, polar lipids and proteins are chemotaxonomical markers in the cytoplasmic membrane of bacteria.
T	F	5. The cell wall contains peptidoglycan and its derivatives: teichoic acids and lipoteichoic acids as chemotaxonomical markers.
T	F	6. The type of peptidoglycan is a very important character of bacterial cell walls.
T	F	7. The glycan part is variable; in some cases variability occurs as such: N-acetyl muramic acid is replaced by N-glycolyl muramic acids (e.g. in some Actinobacteria).
T	F	8. The most important characteristic is the composition of connecting oligopeptides and the structure of interpeptide bridges within the murein layer.
T	F	9. The cell wall diamino-pimelic acid (DAP) content can be studied from whole cells.
T	F	10. High-pressure liquid chromatography (TLC) can be used to investigate the DAP content of heat-treated purified biomass of bacterial cells.

EXERCISE 74-75.

Write the appropriate letter in front of the statement.

A	Isoprenoid quinone analysis
B	Fatty acid analysis
C	Both
D	Neither

	1. Tests the degradation of different amino acids.
	2. Adequate chemotaxonomic method to test the different components of the respiratory chain of a microbe.
	3. Tests the chemical structure of mobile proton and electron carriers of electron transport chains located in the cytoplasmic membrane.
	4. Tests the degradation of different fatty acids within the bacterial cells.
	5. The molecules that are tested with this method are widespread in the nature.
	6. Tests essential molecules of the bacterial cells.
	7. Variability of the molecules that are tested with this method occurs also in the length of the side chain.

REVIEW QUESTIONS

		8. Only prokaryotic biomarkers can be tested with this method.
		9. HPLC is used during the analysis.
		10. Analysis of these molecules contains four steps: liberation of molecules from fats and oils, esterification, extraction, and purification of the extract.

EXERCISE 76.

Select the appropriate letter to indicate whether the statement is true (T) or false (F).

		1. Long chain fatty acids are the intermediates or end-products of fermentations.
		2. Fermentation pathways can be mapped with the study of the end products of microbes.
		3. Analysis of volatile end products of a bacterium is very important in drug industry.
		4. Analysis of fermentation end products supports the classification of anaerobic microorganisms.
		5. The different types of fermentations are characteristic of a given eukaryotic taxon.
		6. In order to test volatile end products, aerobic bacteria must be cultivated in thioglycollate medium.
		7. Volatile end products can be determined from various dairy products and sausages alike.
		8. The organic solvent phase of the extracts is used to determine volatile products.
		9. HPLC is used for the determination of the different components.
		10. In order to identify the short chain fatty acid components of the sample, a special standard in solvent mixture must be used.

EXERCISE 77

Select the appropriate letter to indicate whether the statement is true (T) or false (F).

		1. The first step of DNA extraction covers cell disruption, while in the second part, DNA is purified from other molecules and cell debris.
		2. Disruption of cells can be achieved by chemical, enzymatic or physical methods or with the combination of these.
		3. During DNA extraction with organic solvents, hazardous waste is produced.
		4. DNA purification methods based on anion exchange are based on liquid phase chromatography.
		5. DNA can be purified from ethidium bromide with isopropanol.
		6. DNA can be purified with ethanol precipitation.
		7. Silicate-based DNA purification methods exploit the selective binding of DNA to a silicate gel at low concentration of chaotropic salts.

REVIEW QUESTIONS

T	F	8. CsCl gradient centrifugation is a method for DNA purification.
T	F	9. DNA purity can be checked by spectrophotometric analysis with absorption measured at 660 to 890 nm.
T	F	10. The purity and size of extracted DNA can be checked with agarose gel electrophoresis.
T	F	11. To avoid degradation, DNA should be kept at elevated temperatures (e.g. at 95°C).
T	F	12. One of the simplest chemical cell lysis procedures is the acidic lysis of cells, which applies cc. NaOH solution.
T	F	13. Enzymatic cell lysis procedure can be performed with the application of sterile glass beads.
T	F	14. There are commercial DNA extraction kits available for DNA isolation from bacterial cells.
T	F	15. The first step of agarose gel electrophoresis is gel casting.
T	F	16. Agarose gel solidifies at approximately 80°C.
T	F	17. DNA ladders can be used in gel electrophoresis to achieve a semi-quantitative measurement of DNA.
T	F	18. The presence and quantity of DNA can be detected using specific stains under UV light.

Write the appropriate letter in front of the statement.

A	Physical cell disruption
B	Chemical cell disruption
C	Enzymatic cell disruption
D	All of the above
E	None of the above
F	Some of the above

	1. Cell disruption with a blade homogeniser.
	2. Incubation of cells with lysozyme.
	3. Cell disruption with a mixer mill.
	4. DNA molecules are released from the cells.
	5. Incubation of cells at 98°C for 5 minutes.
	6. Incubation of cells with detergent and protease.
	7. Cell membrane is damaged.
	8. Incubation of cells with lyticase.

REVIEW QUESTIONS

	9. Grinding cells in liquid nitrogen using a mortar.
	10. Incubation of cells in phosphate-buffered saline.

EXERCISE 78

Select the appropriate letter to indicate whether the statement is true (T) or false (F).

T	F	1. Smaller DNA fragments (<5000-10,000 bp) can be amplified by polymerase chain reaction.
T	F	2. During denaturation, DNA strands separate due to incubation at moderate temperature (40-50°C).
T	F	3. In the annealing step of PCR, oligonucleotides hybridise to complementary sites of single-stranded DNA chains at primer-dependent temperature.
T	F	4. During the extension step of PCR, a polymerase enzyme catalyses the synthesis of peptide strands with extension from primers using the dNTPs present in the reaction mixture.
T	F	5. PCR amplifies the region located between the two primers.
T	F	6. Subsequent steps after PCR may require the purification of product from the polymerase enzymes, unbound nucleotides, DNA template and produced primer dimers.
T	F	7. Since the half-life of the DNA polymerase enzyme at 98°C is very short, the addition of the enzyme directly to the master mix would result in the inactivation of a significant amount of the enzyme during the initial annealing step.
T	F	8. The quality of PCR products cannot be checked with agarose gel electrophoresis.
T	F	9. Purified PCR products could be stored for a few days at 4°C.
T	F	10. The PCR master mix usually contains PCR buffer and dNTP mix.

EXERCISE 79

Select the appropriate letter to indicate whether the statement is true (T) or false (F).

T	F	1. In the case of analysing a large number of bacterial strains, the construction of groups with PCR products originating from the same bacterial species can avoid redundant sequencing.
T	F	2. ARDRA stands for Artificial Ribosomal DNA Restriction Analysis.
T	F	3. In ARDRA, nucleic acid molecules are digested with enzymes.
T	F	4. When comparing different bacterial species, the number and position of restriction sites within the 16S rRNA gene is variable.
T	F	5. Enzymatic digestion generates larger DNA fragments when compared with the size of PCR products.
T	F	6. Higher resolution during agarose gel electrophoresis can be achieved by decreasing the electrophoresis time, lowering gel concentration, and increasing the voltage applied for electrophoresis.

REVIEW QUESTIONS

T	F	7. <i>AhuI</i> , <i>BsuRI</i> , <i>Hin6I</i> and <i>TaqI</i> are all restriction endonucleases.
---	---	---

EXERCISE 80

Select the appropriate letter to indicate whether the statement is true (T) or false (F).

T	F	1. The reaction of the dye-terminator cycle sequencing is similar to that of PCR, but contains only one primer, and, in addition to dNTPs, fluorescently labelled ddNTPs are also applied.
T	F	2. Incorporation of a ddNTP molecule into the DNA enhances the extension of the DNA chain.
T	F	3. During dye-terminator cycle sequencing reaction, DNA fragments of different lengths are produced.
T	F	4. After the completion of sequencing reaction, ethanol precipitation is applied to remove enzyme molecules and unbound nucleotides.
T	F	5. Dye-terminator cycle sequencing reactions can be performed in thermocyclers.
T	F	6. A typical sequencing reaction consists of the following cycles: denaturation, annealing and exhaustion.
T	F	7. A genetic analyzer (e.g. model ABI Prism™ 310) is required for DNA nucleotide sequence determination.
T	F	8. DNA fragments can be separated by capillary electrophoresis.
T	F	9. Sequencing biases could arise during both the sequencing reaction and capillary electrophoresis.
T	F	10. After capillary electrophoresis, manual correction of automatic base calling on chromatograms is not recommended.

EXERCISE 81

Select the appropriate letter to indicate whether the statement is true (T) or false (F).

T	F	1. Special PCRs are suitable for generating individual fingerprinting patterns of bacterial strains.
T	F	2. RAPD stands for the Random Amplification of Parallel DNA strands.
T	F	3. RAPD is a PCR technique.
T	F	4. During the RAPD technique, extreme high temperatures are applied to achieve attachment of oligonucleotide(s) to different regions within the genome.
T	F	5. A conventional RAPD technique generates 16S rRNA gene fragments of various lengths.
T	F	6. The prerequisite of a RAPD analysis is a genome as intact as possible.
T	F	7. RAPD amplification products can be analysed by agarose gel electrophoresis.

EXERCISE 82-83

Select the appropriate letter to indicate whether the statement is true (T) or false (F).

REVIEW QUESTIONS

T	F	1. Coliforms in hygienic practice are defined as obligate anaerobic, Gram-negative, non-endospore-forming, rod-shaped bacteria that ferment lactose by producing acid and gas within 48 hours at 37°C.
T	F	2. Coli-count is the number of coliform bacteria that can be cultivated from 1 L of water sample.
T	F	3. Coli-titer is the smallest amount of water from which coliform organisms can still be cultivated.
T	F	4. <i>E. coli</i> , <i>Enterobacter aerogenes</i> and <i>Klebsiella pneumoniae</i> are coliform bacteria.
T	F	5. Coliforms are members of the family Enteromycetaceae.

Write the appropriate letter in front of the statement.

A	1. Eosin-Methylene Blue (EMB) agar
B	1. Endo agar
C	1. Both
D	1. Neither

	Differential medium.
	Suitable to determine the count of coliform bacteria.
	Coliform bacterial colonies on the surface of the medium are purplish blue.
	Contains red alkaline fuchsin.
	Coliform bacterial colonies on the surface of the medium are dark gray with a metallic shine.

EXERCISE 84

Select the appropriate letter to indicate whether the statement is true (T) or false (F).

T	F	1. MUG can be cleaved with the glucuronidase enzyme.
T	F	2. Gtrth of coliform bacteria in the LMX medium is detected with the emitted fluorescence at 660 nm under illumination with white light.
T	F	3. Approximately 40% of <i>E. coli</i> strains produce the glucuronidase enzyme.

EXERCISE 85

Select the appropriate letter to indicate whether the statement is true (T) or false (F).

T	F	1. Phages replicate in bacterial cells.
T	F	2. The phage that infects <i>Escherichia coli</i> is called coliphage.
T	F	3. Coliphages can be detected as the presence of plaques (clear zones) that develop in the lawn of bacteria.

REVIEW QUESTIONS

T	F	4. TTC stands for triphenyl-tetrazolium-chloride.
T	F	5. Bacterial growth can be indicated by the oxidation of TTC to the red triphenyl-phormazane compound.

EXERCISE 86

Select the appropriate letter to indicate whether the statement is true (T) or false (F).

T	F	1. Members of the genera <i>Staphylococcus</i> and <i>Streptococcus</i> are the most important bacteria among Gram-negative cocci.
T	F	2. All <i>Staphylococcus</i> and <i>Streptococcus</i> species are pathogenic for animals and/or humans.
T	F	3. <i>Streptococcus faecalis</i> (<i>Enterococcus faecalis</i>) dies in water quickly and does not reproduce in non-faecal environment.
T	F	4. The presence of <i>Streptococcus faecalis</i> in water indicates the fresh contamination of water with animal blood.
T	F	5. The selectivity of the Szita E-67 medium for <i>Streptococcus</i> is assured by the chlorite and Fe-taurocolate content of the medium.

EXERCISE 87

Select the appropriate letter to indicate whether the statement is true (T) or false (F).

T	F	1. Members of the genus <i>Pseudomonas</i> are widespread in soil and water.
T	F	2. Pseudomonads are Gram-positive, strictly respiring, mostly obligate aerobic bacteria with polar flagella.
T	F	3. <i>Pseudomonas aeruginosa</i> is a common bacterium in different waters.
T	F	4. Brolacin nutrient medium contains sucrose, yeast extract, glutamate and methyl red indicator.
T	F	5. Colonies of pseudomonads on brolacin agar appear blue in the centre and the surrounding area of the agar is light green.
T	F	6. The presence of pseudomonads indicates fresh contamination.
T	F	7. Pseudomonads may attack weak patients and immunocompromised individuals.

EXERCISE 88

Select the appropriate letter to indicate whether the statement is true (T) or false (F).

T	F	1. The quantity and activity of microorganisms can be estimated on the basis of catalase activity in a soil sample.
T	F	2. Soil microorganisms play a significant role in the decomposition of organic matter and humus formation.
T	F	3. Catalase enzyme is present only in bacteria.

REVIEW QUESTIONS

EXERCISE 89

Select the appropriate letter indicating whether the statement is true (T) or false (F).

T	F	1. Anaerobic biological activity of soil samples can be estimated with the measurement of CO ₂ production.
T	F	2. During oxidation of glucose to CO ₂ , the O ₂ , which serves as the terminal electron acceptor, is reduced to H ₂ O.
T	F	3. During glucose oxidation, only reducing power (NADH) is generated.
T	F	4. In traditional "Biometer" flasks, the produced CO ₂ is trapped in hydrochloric acid solution.
T	F	5. The amount of CO ₂ produced depends on the biodegradability of the organic substrate and the metabolic efficiency of microorganisms participating in the process.

EXERCISE 90

Select the appropriate letter to indicate whether the statement is true (T) or false (F).

T	F	1. Biological nitrogen fixation is carried out by bacteria, fungi and some protists.
T	F	2. During the process of nitrogen fixation, the oxidation state of the nitrogen atom is reduced from 2 (nitrogen gas) to -3 (ammonia).
T	F	3. The ammonia gained by nitrogen fixation can later be assimilated.
T	F	4. Nitrogen-fixing organisms can be divided into free-living organisms and symbionts.
T	F	5. <i>Rhizobium</i> species are associated with ascidians.
T	F	6. Bacteroids have characteristic morphology and they fix atmospheric ammonium.
T	F	7. All nitrogen-fixing prokaryotes are anaerobic microorganisms.
T	F	8. The nitrogenase enzyme is very sensitive to the presence of oxygen.
T	F	9. The nodules of leguminous plants contain leg-hemoglobin.
T	F	10. Leg-hemoglobin is responsible for the cleavage of the nitrogenase enzyme.

EXERCISE 91

Select the appropriate letter to indicate whether the statement is true (T) or false (F).

T	F	1. <i>Cylindrospermopsis raciborskii</i> is capable of nitrogen fixation.
T	F	2. Heterocysts are specialised thick-walled, nitrogen-fixing cells of cyanobacteria.
T	F	3. Cell morphology of different cyanobacteria can be studied with light microscopy.
T	F	4. All free-living cyanobacteria have heterocysts.

REVIEW QUESTIONS

T	F	5. All cyanobacteria are filamentous.
---	---	---------------------------------------

EXERCISE 92

Select the appropriate letter to indicate whether the statement is true (T) or false (F).

T	F	1. During ammonification, organic nitrogen compounds form covalent bonds with ammonium ions.
T	F	2. In deamination reactions, bacteria use the common enzymes-glycolate deaminases.
T	F	3. Within the nitrogen cycle, ammonification is considered as a mineralisation step.
T	F	4. Ammonia and ammonium ion released during ammonification can be taken up and used for amino acid synthesis by other organisms.
T	F	5. Ammonia and ammonium ion can be absorbed in the soil by humus-colloids.
T	F	6. The presence of ammonia in the broth can be demonstrated by adding a few drops of Nessler's reagent.
T	F	7. After the addition of Nessler's reagent for ammonia detection, positive reaction yields a blue coloured precipitation.

EXERCISE 93

Select the appropriate letter to indicate whether the statement is true (T) or false (F).

T	F	1. Certain bacteria can gain energy by utilising ammonia as electron donor.
T	F	2. Nitrification can be carried out by some heterotrophic microorganisms.
T	F	3. Within the nitrogen cycle, ammonification is considered as a mineralisation step.
T	F	4. Plants can take up ammonia more easily than nitrate.
T	F	5. Nitrate can be leached out from soils easily due to its higher degree of mobility.
T	F	6. The key enzyme of ammonia-oxidation is a dioxigenase.
T	F	7. Allyl-thiourea can inhibit the key enzyme of nitrite oxidation.
T	F	8. The Griess-Ilosvay-reagent is suitable for the direct detection of nitrate.
T	F	9. The characteristic positive reaction of Griess-Ilosvay-reagent is shown by cherry red colour within 30 seconds.
T	F	10. Zinc reduces nitrate to nitrogen gas.

Write the appropriate letter in front of the statement.

A	Ammonia-oxidizing bacteria
B	Nitrite-oxidizing bacteria

REVIEW QUESTIONS

C	Both
D	Neither

	1. Utilize inorganic nitrogen compounds as electron donor.
	2. Chemolithoautotrophic bacteria.
	3. A typical genus of this group is <i>Nitrosomonas</i> .
	4. A typical genus of this group is <i>Pseudomonas</i> .
	5. Nitrifying bacteria.

EXERCISE 94

Select the appropriate letter to indicate whether the statement is true (T) or false (F).

T	F	1. During the assimilatory nitrate reduction, the end-products are nitrite, dinitrogen-oxide or nitrogen gas.
T	F	2. The process of dissimilatory nitrate reduction is anaerobic and takes place in compacted environments.
T	F	3. During denitrification, a gaseous nitrogen compound is produced.
T	F	4. Denitrification is a form of assimilatory nitrate reduction.
T	F	5. Denitrification usually generates eutrophication in aquatic habitats.
T	F	6. During denitrification, the biological oxidation of different organic and inorganic substances takes place.
T	F	7. Denitrification can be demonstrated with nitrate broth, which contains a Durham tube.

EXERCISE 95

Select the appropriate letter to indicate whether the statement is true (T) or false (F).

T	F	1. The transformation between different sulphur forms may take place abiotically.
T	F	2. Sulphate-reducing bacteria (SRB) can transform fermentation end-products under anaerobic conditions.
T	F	3. SRB use especially sulphate as electron donor.
T	F	4. The metabolic end-product of the dissimilatory sulphate reduction is sulphide ion or hydrogen sulphide.
T	F	5. The typical organic substrates of SRB are lignine, cellulose and murein.
T	F	6. Acid-producing bacteria provide carbon dioxide to the SRB to enhance their biosynthetic pathways.
T	F	7. SRB can be found among Gram-negative, Gram-positive Bacteria and Archaea.

REVIEW QUESTIONS

T	F	8. All SRB show hydrogenase activity.
T	F	9. SRB have economic importance since they play an important role in metal corrosion.
T	F	10. Postgate's Medium B has a differentiating effect based on the appearance of black lead sulphite precipitation due to bacterial sulphate reduction.

EXERCISE 96

Select the appropriate letter to indicate whether the statement is true (T) or false (F).

T	F	1. Ethanol production in the industry is carried out by <i>Saccharomyces cerevisiae</i> cells.
T	F	2. Some advantages of immobilised cell techniques are high cell density, microbial biomass can be reused multiple times, continuous fermentation process is achievable and the product can be easily purified after fermentation.
T	F	3. In the case of binding-to-carriers immobilisation, cells or enzymes are bound to a solid carrier.
T	F	4. Carriers used for cell immobilisation can be water-soluble polysaccharides or microdroplets of lipids.
T	F	5. In the cross-linking immobilisation method, reagents have a single functional group that reacts with the cells.
T	F	6. In the capturing/inclusion method, cells are enclosed in a polymer material.
T	F	7. Alginate is a polymer.

EXERCISE 97

Select the appropriate letter to indicate whether the statement is true (T) or false (F).

T	F	1. Nowadays, citric acid is produced microbiologically by <i>Claviceps purpurea</i> .
T	F	2. The most important carbon source for citric acid production is glutamine.
T	F	3. Citric acid is produced during the trophophase.
T	F	4. Citric acid production can be demonstrated by thin layer chromatography.
T	F	5. Scheppe's reagent reacts with citric acid after incubation at 37°C for 50 minutes, which results in a yellow colouration.

EXERCISE 98

Select the appropriate letter to indicate whether the statement is true (T) or false (F).

T	F	1. Phenotypic character-based identification systems are called taxometrics or numerical taxonomy.
T	F	2. OTU stands for Operational Taxonomic Unit.
T	F	3. Quantitative variables can be coded directly in a binary way.

REVIEW QUESTIONS

T	F	4. UPGMA stands for Unweighted Potential Group Model of Archaea.
T	F	5. The similarity among the strains can be visualised by a dendrogram.

EXERCISE 99

Select the appropriate letter to indicate whether the statement is true (T) or false (F).

T	F	1. The chlorophyll-a content of phytoplankton can be determined by ethanol or methanol extraction.
T	F	2. The quality requirements of natural spas include the determination of the chlorophyll-a content of water.
T	F	3. The characteristic extinction of chlorophyll-a can be measured with a spectrophotometer.

EXERCISE 100

Select the appropriate letter to indicate whether the statement is true (T) or false (F).

T	F	1. According to the Water Framework Directive of the European Union, benthic diatoms should be monitored in aquatic ecosystems.
T	F	2. Taxonomic identification of diatoms is mainly based on the special silica-based structures of their cell membranes.
T	F	3. Diatom preparation for light microscopic investigations can be made with the complete destruction of the cell wall.

17. REFERENCES

- Atlas, R.M.. 1996. *Principles of Microbiology*. 2nd revised edition. Mosby College.
- Atlas, R.M.. 2010. *Handbook of Microbiological Media*. 4th edition. CRC Press, New York.
- Dworkin, M., Falkow, S., Rosenberg, E., Schleifer, K-H., és Stackebrandt, E. (eds). 2006. *The Prokaryotes*. 3rd edition. Springer, New York.
- Euzéby, J.P.. 2010. *List of Prokaryotic names with Standing in Nomenclature*. www.bacterio.net.
- Fleming, O.D. és Hunt, D.L.. 2006. *Biological Safety: Principles and Practices*. 4th edition. ASM Press.
- Garrity, G.M. (Editor-in-chief). 2001-2012. *Bergey's Manual of Systematic Bacteriology*. 2nd edition. Springer, New York.
- Garrity, G.M.. 2005. *Bergey's Manual of Systematic Bacteriology*. Volume Two: The Proteobacteria, Part A Introductory Essays. 2nd edition. Springer, New York.
- Garrity, G.M.. 2005. *Bergey's Manual of Systematic Bacteriology*. Volume 2: The Proteobacteria. 2nd edition. Springer, New York.
- Garrity, G.M., Boone, D.R., és Castenholz, R.W.. 2001. *Bergey's Manual of Systematic Bacteriology*. Volume One: The Archaea and the Deeply Branching and Phototrophic Bacteria. 2nd edition. Springer, New York.
- Garrity, G.M., Brenner, D.J., Krieg, N.R., és Staley, J.R.. 2005. *Bergey's Manual of Systematic Bacteriology*. Volume 2: The Proteobacteria, Part B: The Gammaproteobacteria. 2nd edition. Springer, New York.
- Garrity, G.M., Brenner, D.J., Krieg, N.R., és Staley, J.T.. 2005. *Bergey's Manual of Systematic Bacteriology*. Volume Two: The Proteobacteria (Part C). 2nd edition. Springer, New York.
- Glick, B.R., Pasternak, J.J., és Patten, C.L.. 2010. *Molecular Biotechnology: Principles and Applications of Recombinant DNA*. 4th edition. ASM Press.
- Harley, J.P. és Harley, J.. 2004. *Laboratory Exercises in Microbiology*. 6th edition. McGraw-Hill.
- Krieg, N.R., Ludwig, W., Whitman, W.B., Hedlund, B.P., Paster, B.J., Staley, J.T., Ward, N., Brown, D., és Parte, A.. 2010. *Bergey's Manual of Systematic Bacteriology*. Volume 4: The Bacteroidetes, Spirochaetes, Tenericutes (Mollicutes), Acidobacteria, Fibrobacteres, Fusobacteria, Dictyoglomi, Gemmatimonadetes, Lentisphaerae, Verrucomicrobia, Chlamydiae, and Planctomycetes. 2nd edition. Springer, New York.
- Legendre, P. és Legendre, L.. 1998. *Numerical ecology*. 2nd English edition. Elsevier, Amsterdam.
- Lep, J. és Milauer, P.. 2003. *Multivariate analysis of ecological data using CANOCOTM*. Cambridge University Press, Cambridge.
- Madigan, M.T., Martinko, J.M., Stahl, D., és Clark, D.P.. 2010. *Brock Biology of Microorganisms*. 13th edition. Benjamin/Cummings Pub Co.
- Podani, J.. 2000. *Introduction to the exploration of multivariate biological data*. Backhuys, Leiden.
- Sambrook, J. és Russell, D.W.. 2001. *Molecular cloning: a laboratory manual*. Cold Spring Harbor Laboratory Press, New York.
- Schaechter, M. (Editor-in-chief) és . 2009. *Encyclopedia of Microbiology*. 3rd edition. Elsevier Inc.
- Singleton, P. és Sainsbury, D.. 2006. *Dictionary of Microbiology and Molecular Biology*. 3rd edition. Wiley.

- Vos, P., Garrity, G.M., Jones, D., Krieg, N.R., Ludwig, W., Rainey, F.A., Schleifer, K.-H., és Whitman, W.B.. 2009. *Bergey's Manual of Systematic Bacteriology*. Volume 3: The Firmicutes. 2nd edition. Springer, New York.
- Whitman, W.B., Goodfellow, M., Kämpfer, P., Busse, H.-J., Trujillo, M.E., Ludwig, W., Suzuki, K.-I., és Parte, A.. 2012. *Bergey's Manual of Systematic Bacteriology*. Volume 5: The Actinobacteria. 2nd edition. Springer, New York.
- Willey, J.M., Sherwood, L.M., és Woolverton, C.J.. 2011. *Prescott's Microbiology*. 8th edition. The McGraw-Hill Companies.